

EVOLUTION OF AIRBORNE REMOTE SENSING 1783-1950

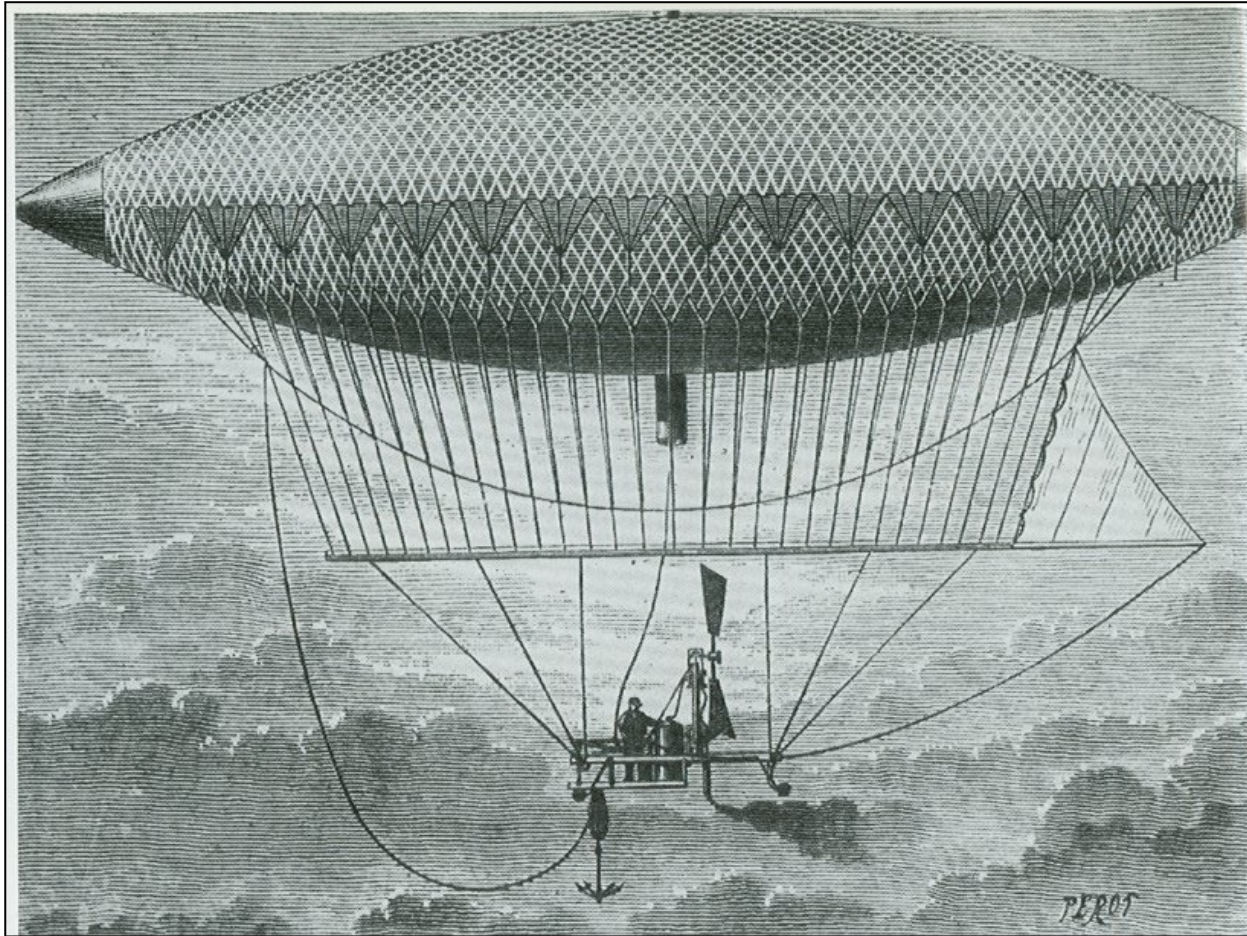

- **Professor Charles de Rozier and his brother Pilatre succeeded in launching a hydrogen filled balloon from Tuileries, France in September 1783**
- **4 hour flight covered 63 km**



- **Henri Giffard employed the first powered airship in 1853 using a 3 horsepower steam engine. It achieved a speed of between 6.5 and 10 feet per second in calm weather**



- Credit for the first aerial photograph goes to French author and artist Felix Tournachon who used the *nom de plume* Nadar. He captured the first aerial photo from a balloon tethered over the Bievre Valley in 1858.
- The oldest extant aerial photograph is this view of Boston by James Wallace Black in 1860, made from a captive balloon.



- **Professor T.S.C. Lowe used hot air balloons to make aerial reconnaissance of Confederate positions for Union forces during the Peninsula Campaign in 1862.**



- **The heliograph was invented in Great Britain in 1865 for transmitting messages by mirror, using Morse Code**
- **The US Army began using heliographs for signaling in 1877 during the Indian Wars, under BGEN Nelson A. Miles, and enjoyed great tactical successes**

Heliograph with Jointed Sighting Rod.

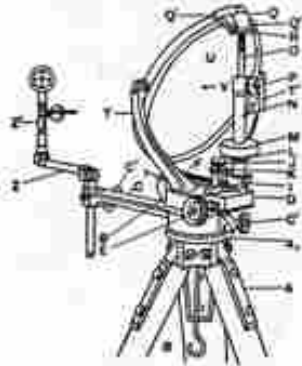

FIG. 28.

Heliograph with Straight Sighting Rod.

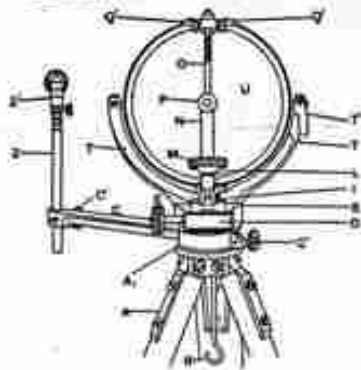

FIG. 29.

Heliograph with Duplex Mirror.

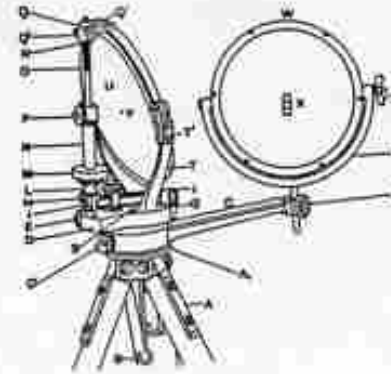
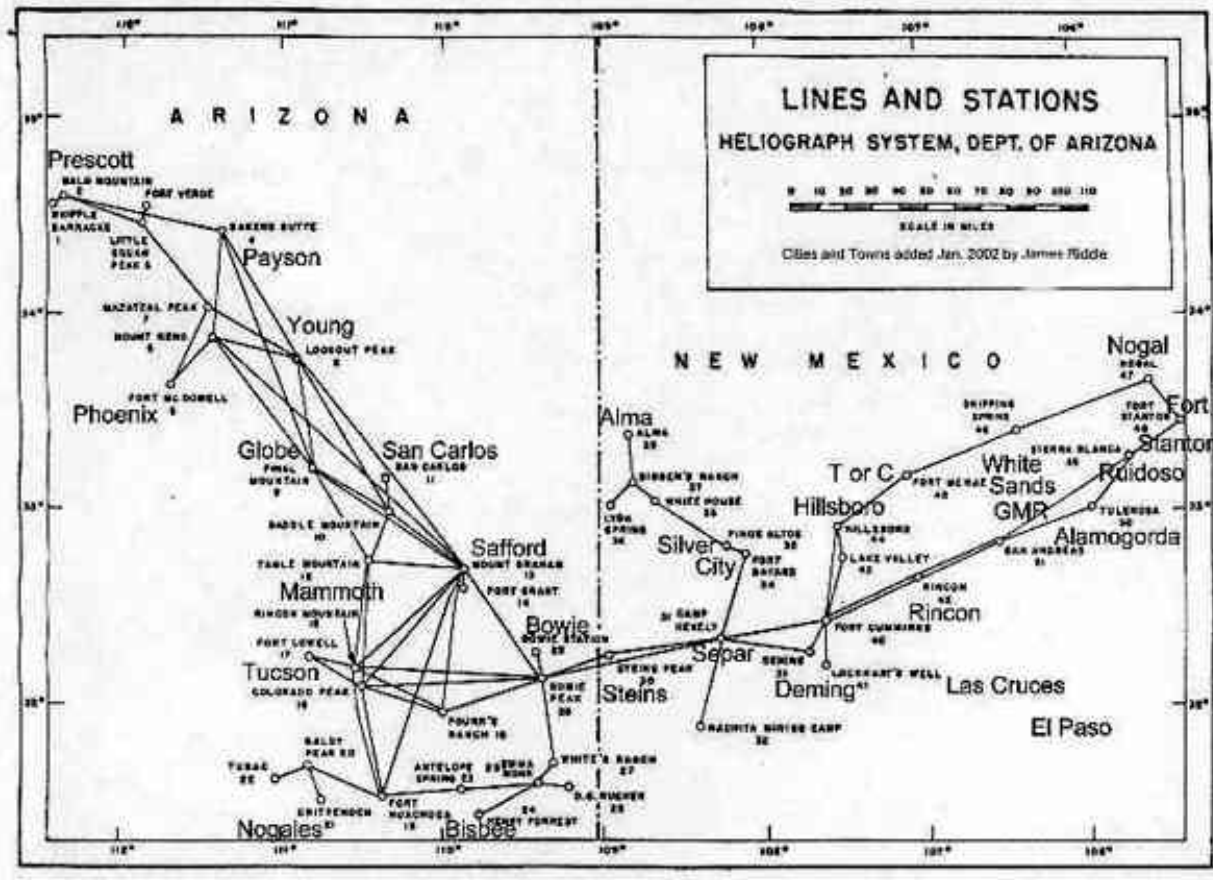

FIG. 30.

- A. Stand. A1. Lens held.
 B. Anchoring beam.
 C. Sight arm with clamping screw C'.
 D. Tangent box with lid below.
 E. Tangent screw.
 F. Key.
 G. Key spring.
 H. Key handle.
 I. Key handle.
 J. Nut regulating screw.
 K. Lock nut for lens regulating screw.
 L. Swivel joint.
 M. Collar.
 N. Vertical socket.
 O. Vertical screw rod.
 P. Clamping screw for vertical screw rod.
 Q. German silver ball attached to claw Q'.
 R. Adjustable screw for German silver ball.
 S. Glass plate.
 T. U arm, with detachable portion T' and screws adjusting.
 U. Signaling mirror in frame.
 V. Numbered spot at centre of signaling mirror.
 W. Duplex mirror with frame in U arm (U').
 X. Sighting arm on duplex mirror.
 Y. Nuttery and pointing screw.
 Z. Sighting rod with movable cases Z'.

- The heliograph employed a polished tin mirror and sighting lens to allow the correct set up between sun angle and intended target of the reflection



■ **General Miles established a heliograph communications network across the Arizona and New Mexico territories to establish a near real time system of communications for combating sporadic Apache Indian raids**

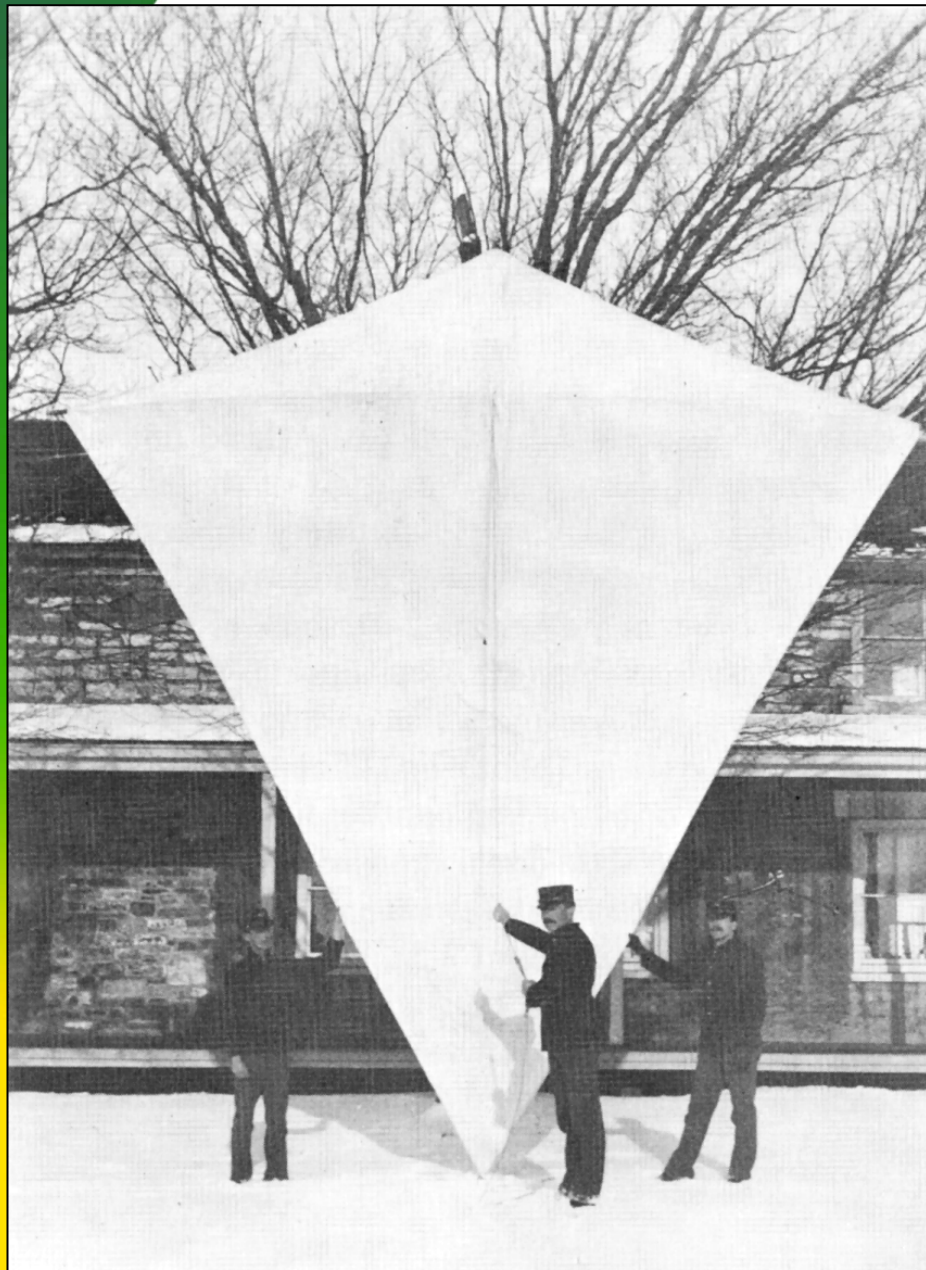

- **In 1895 the Army Signal Corps began using kites to carry aerial cameras aloft for reconnaissance purposes**
- **Panoramic photos of major cities were becoming fashionable at the time, imaged from large kites such as this**

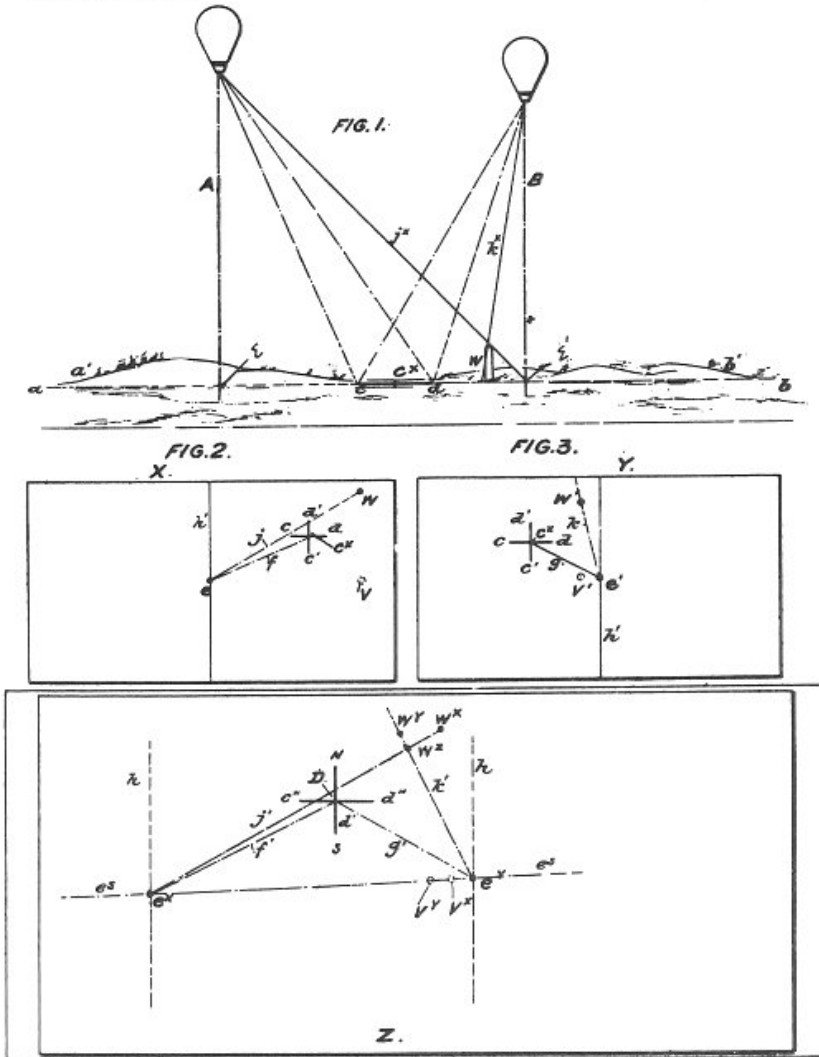

- Stereo aerial imagery from two balloons was patented by American C.B. Adams in 1893.
- Stereo terrestrial images had been popular since the mid-1850s
- The Army Signal Corps expressed interest in the idea, but did not use it until 1908.

WITNESSES:

Fred L. Dieterich
W. R. Blondel

FIG. 4.

INVENTOR

Cornele B. Adams
BY *Munn & Co*

ATTORNEYS.

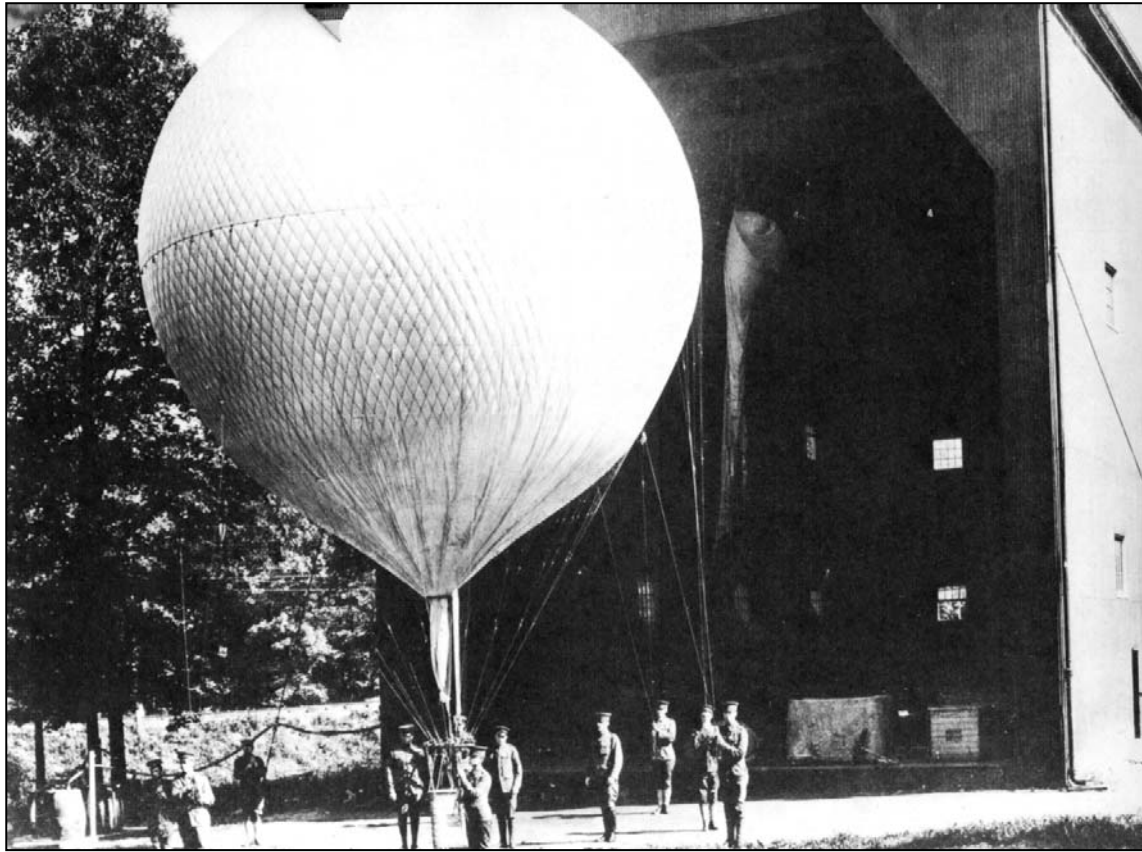

- **In 1908 the Army Signal Corps began purchasing observation balloons to use in tactical settings. These were equipped with telephones that allowed the occupants to relay real-time observations to the ground, mostly for artillery spotting.**

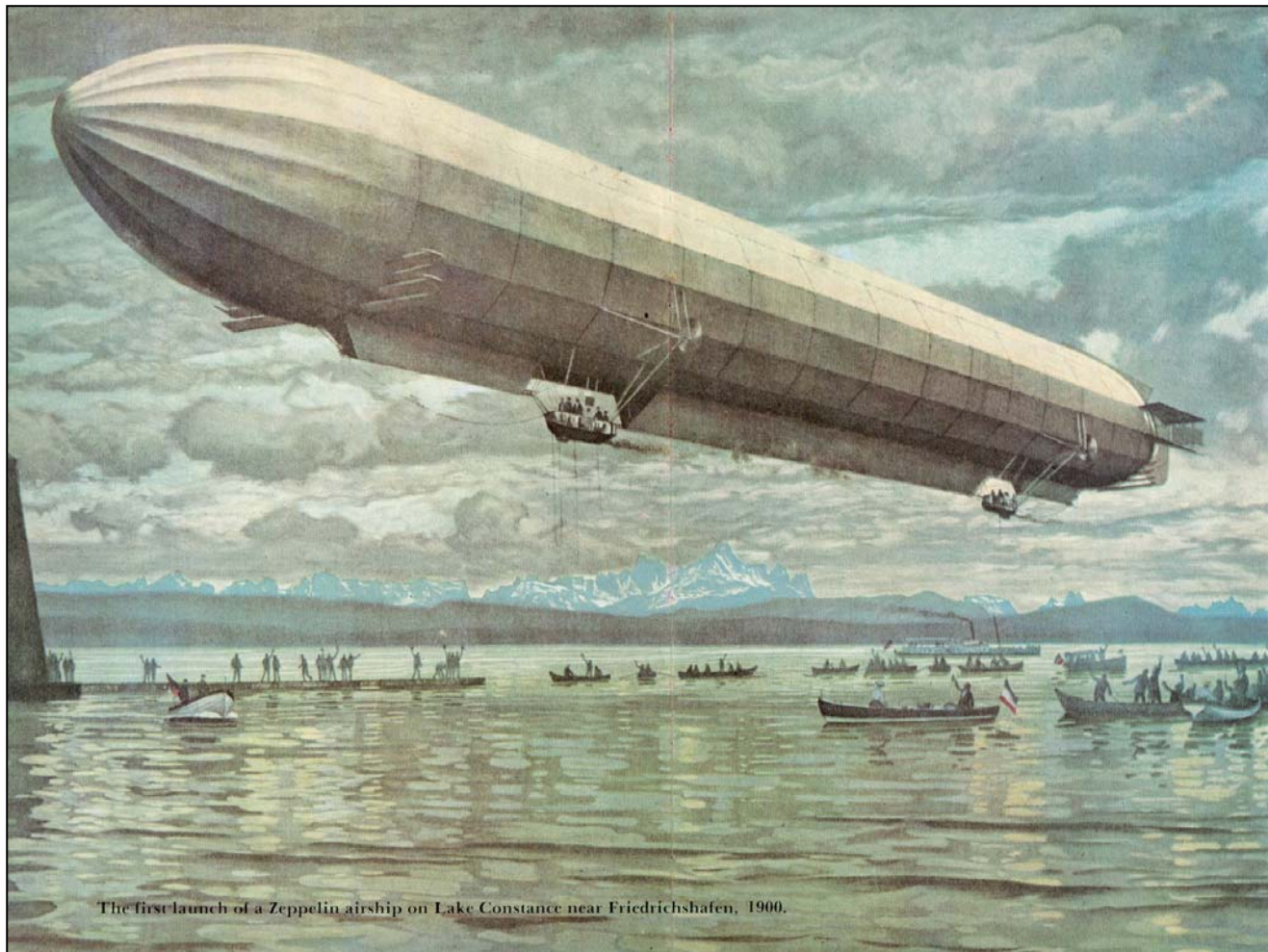

- **Germany began employing Zeppelin lighter-than-air rigid airships for passenger service in 1900.**

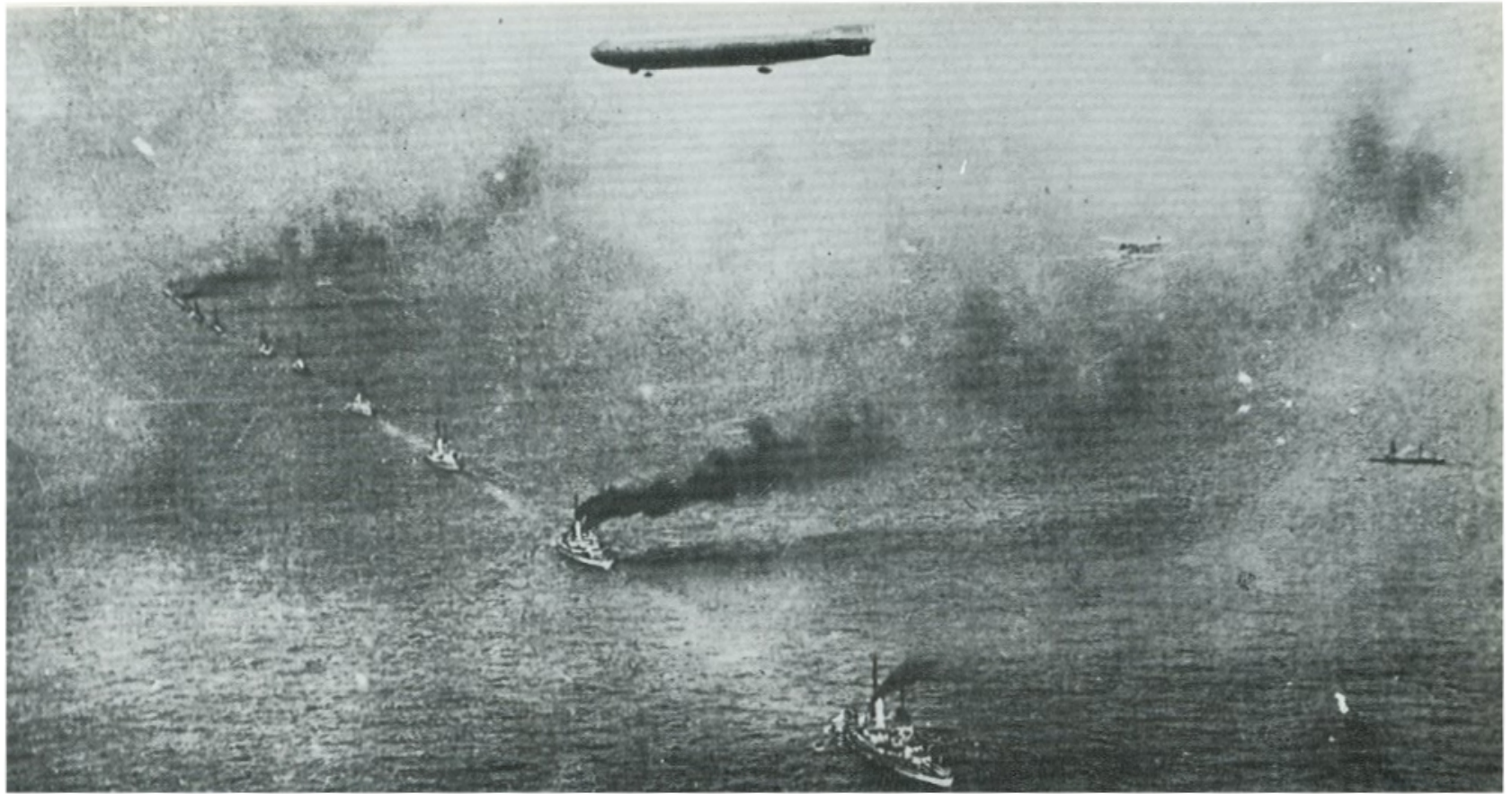

- **During World War I the Germans began to employ Zeppelins for fleet reconnaissance, as shown here**

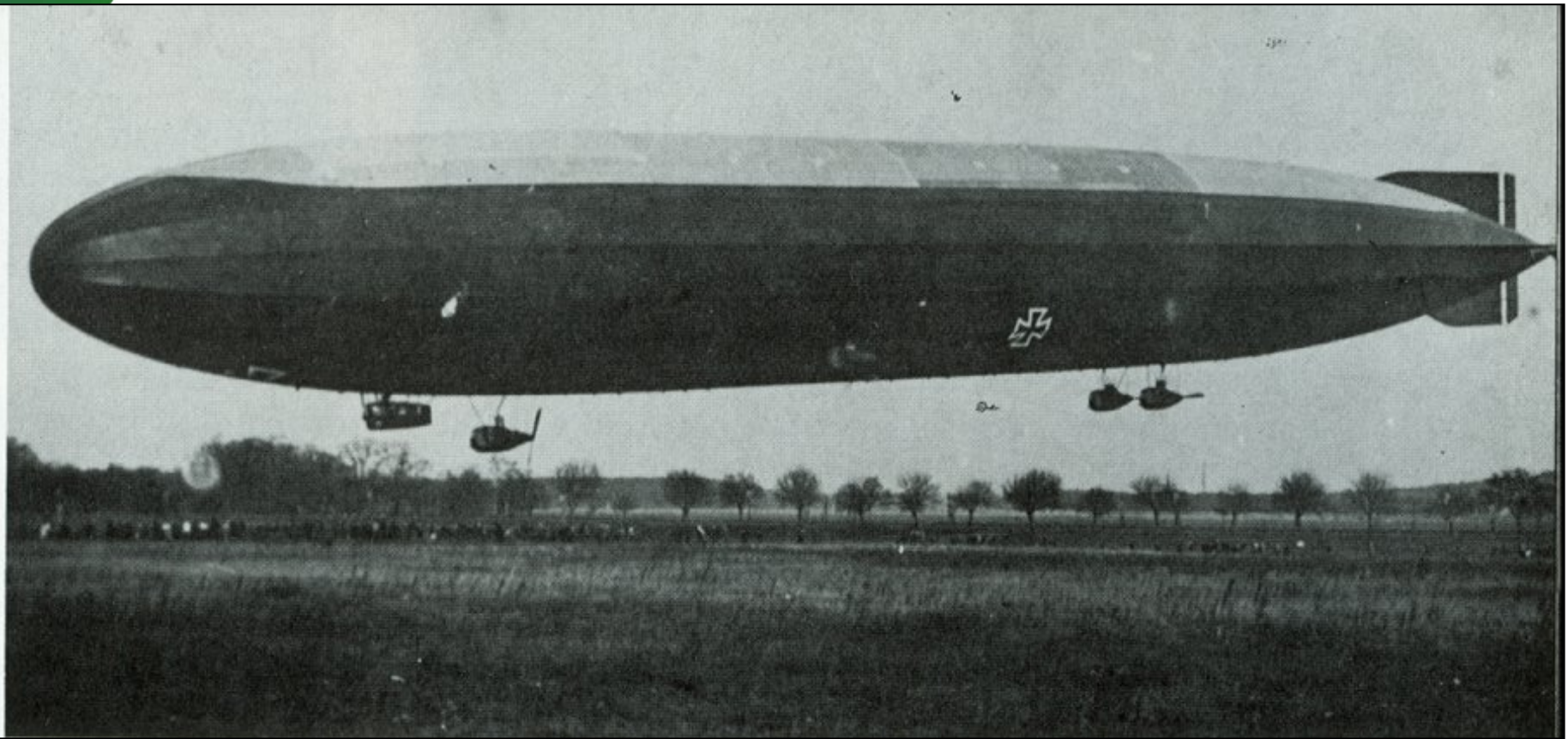

- **In early 1915 the Germans began attacking London with Zeppelins at night. These massive airships carried out nighttime bombing of France and Great Britain in increasing numbers until the end of the war. Note the black camouflage applied to the airship's underside.**

Early Reconnaissance Flights

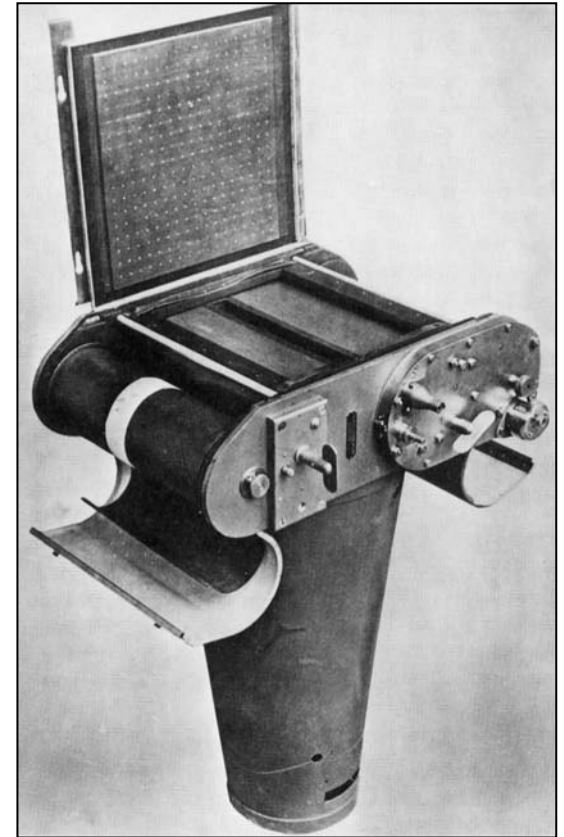
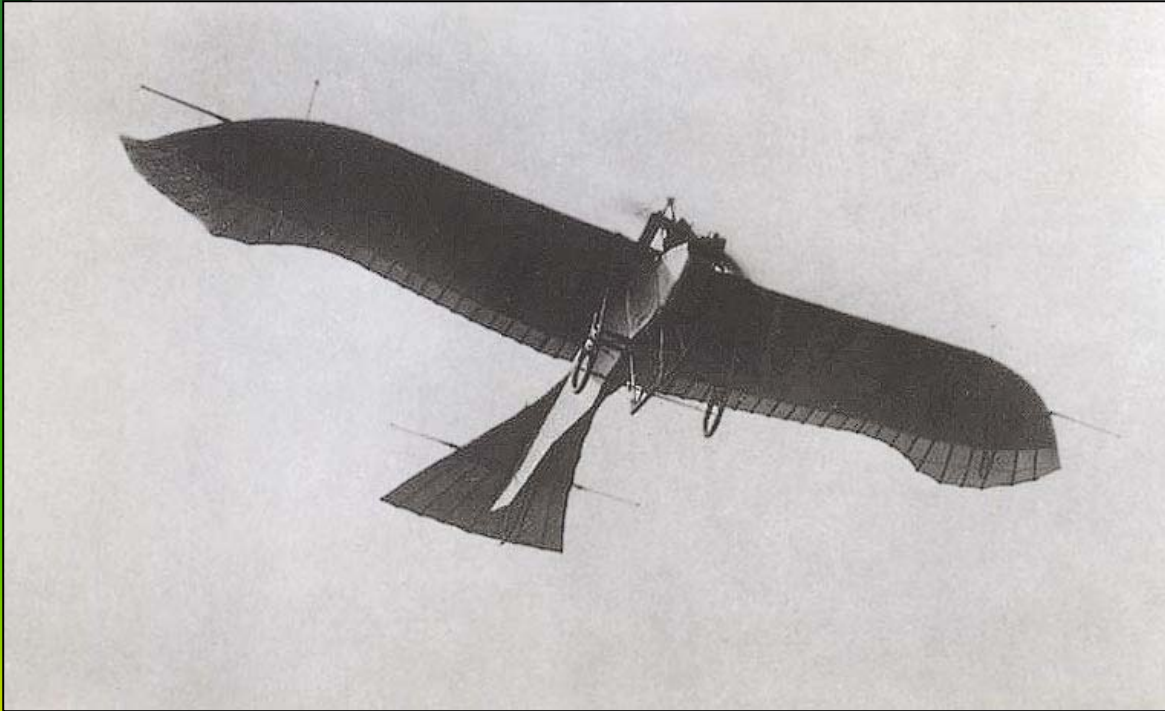

- The Germans initially employed the Rumpler Taube as their first reconnaissance aircraft and in the early days a gentlemanly agreement existed between each side not to molest the other's aircraft. The Kodak K-1 camera was the staple American camera used during the closing days of World War I

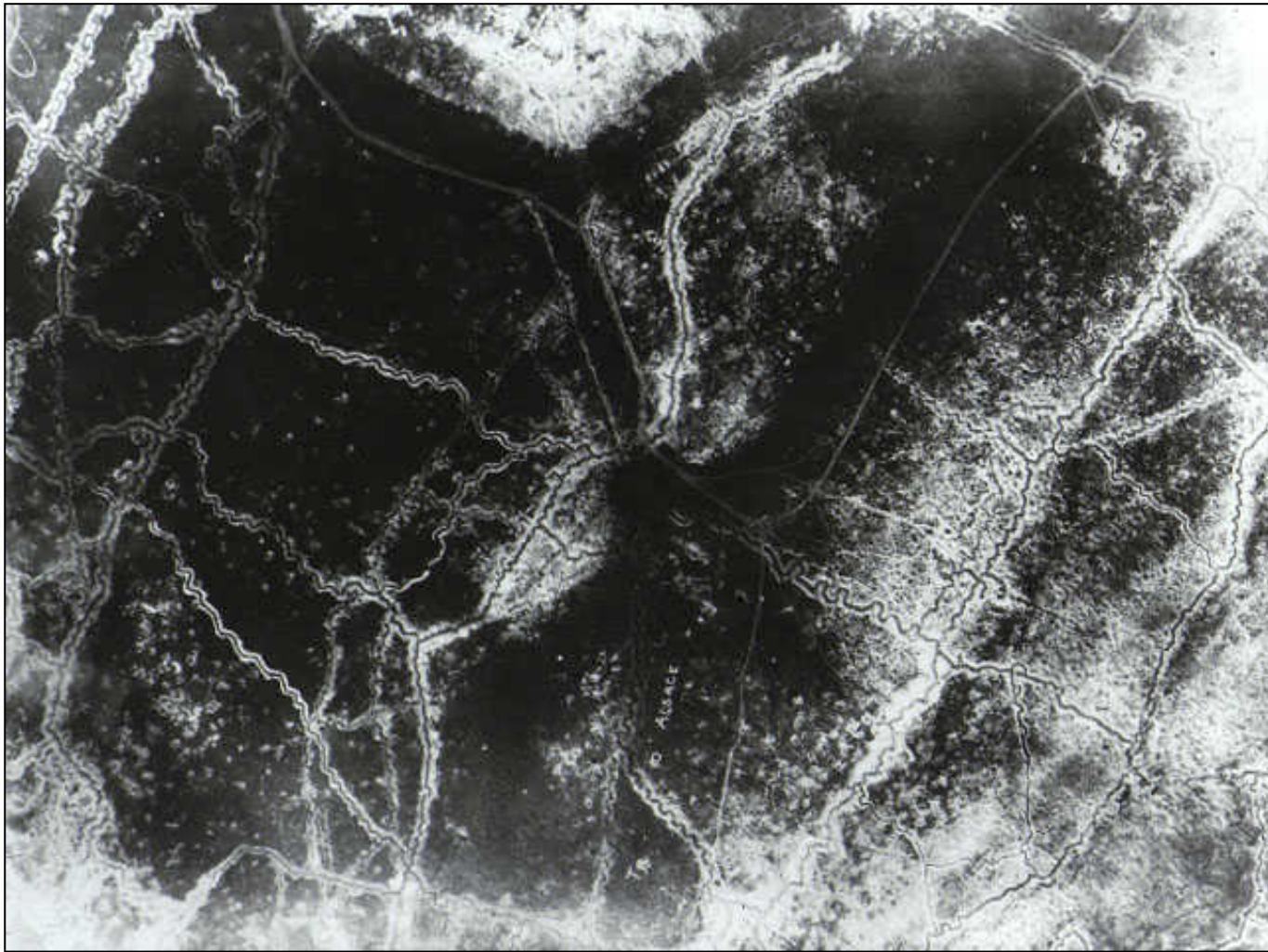

- Propeller driven aircraft were gradually deployed to acquire vertical aerial photos of entrenchments near the front lines during World War I. The use of aerial photography accelerated dramatically during the war.



- **The first UAV, or guided missile, was the Kettering Bug developed by Delco and Sperry companies in 1917-18. It was an unpowered biplane bomber made of wood, weighing just 270 kg, including a 135-kg bomb as payload, and was powered by a 40-h.p. Ford engine**

Sherman Fairchild



— Sherman Fairchild took on the task of constructing a focal plane shutter equipped aerial camera during World War I, but didn't get it completed until 1920. This camera revolutionized aerial photography.

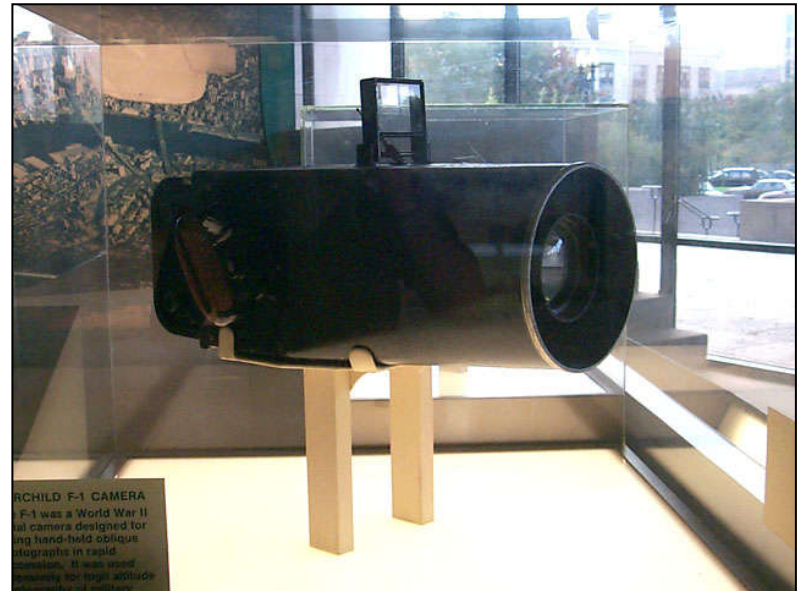

Fairchild Aircraft



Fairchild introduced a series of aircraft beginning with the venerable F-1 series in 1926, which had fold-back wings. Intended as aerial survey craft, they were used in many different roles



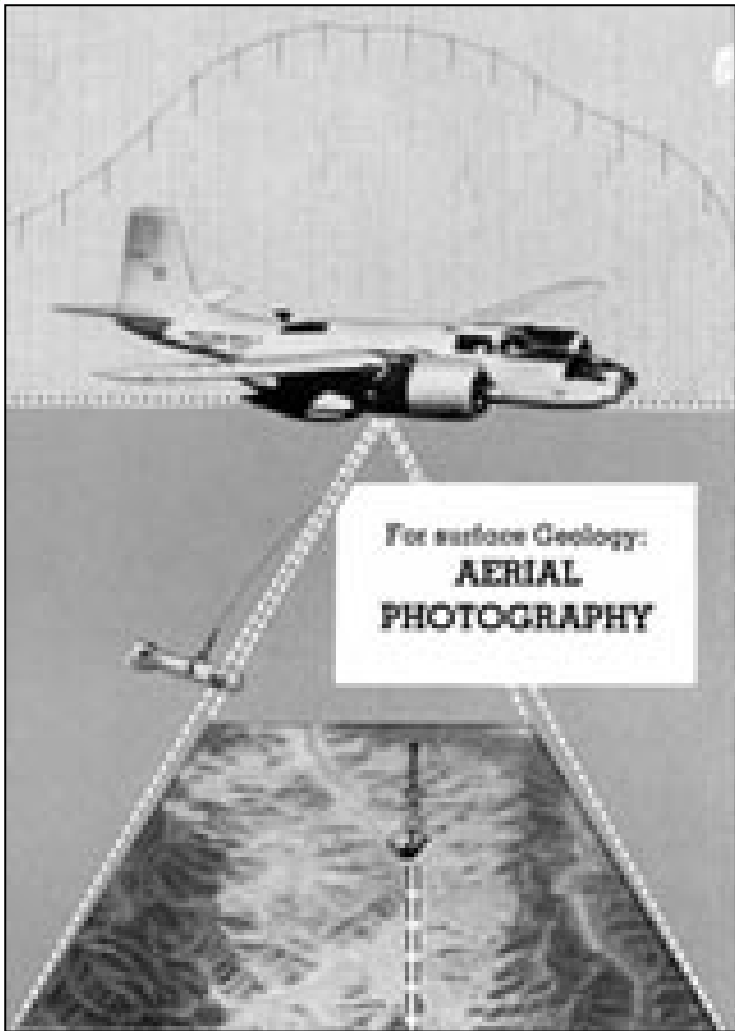

Fairchild went on to pioneer the commercial applications of aerial photography and photogrammetry from 1922 until 1964.

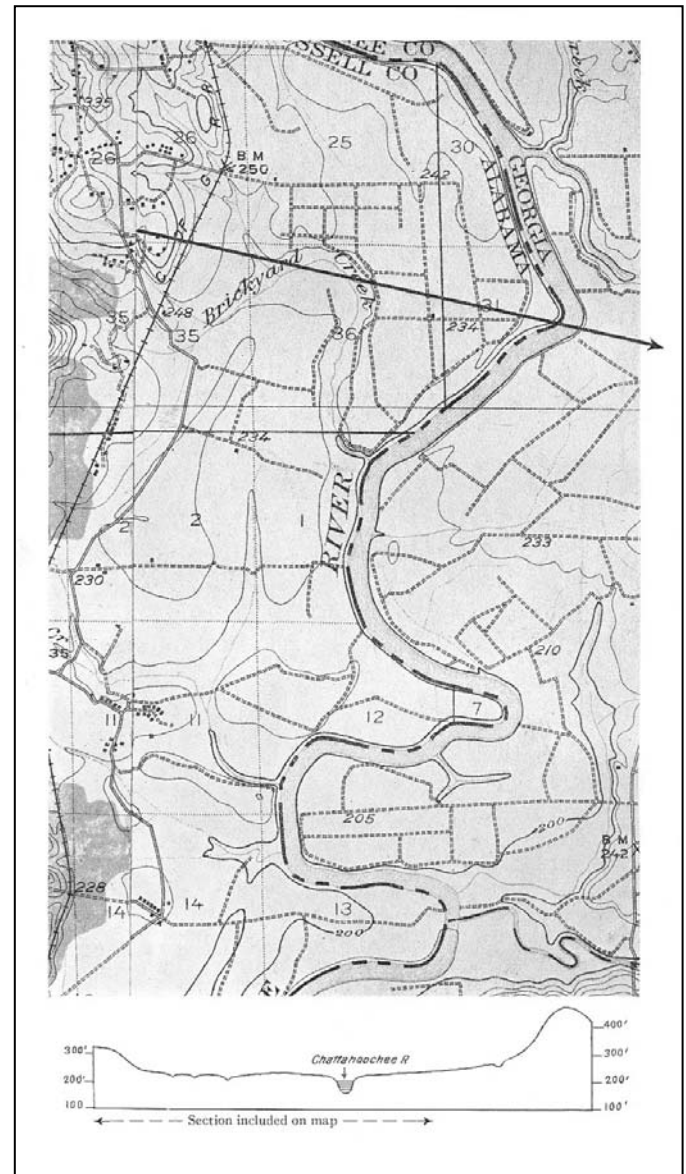
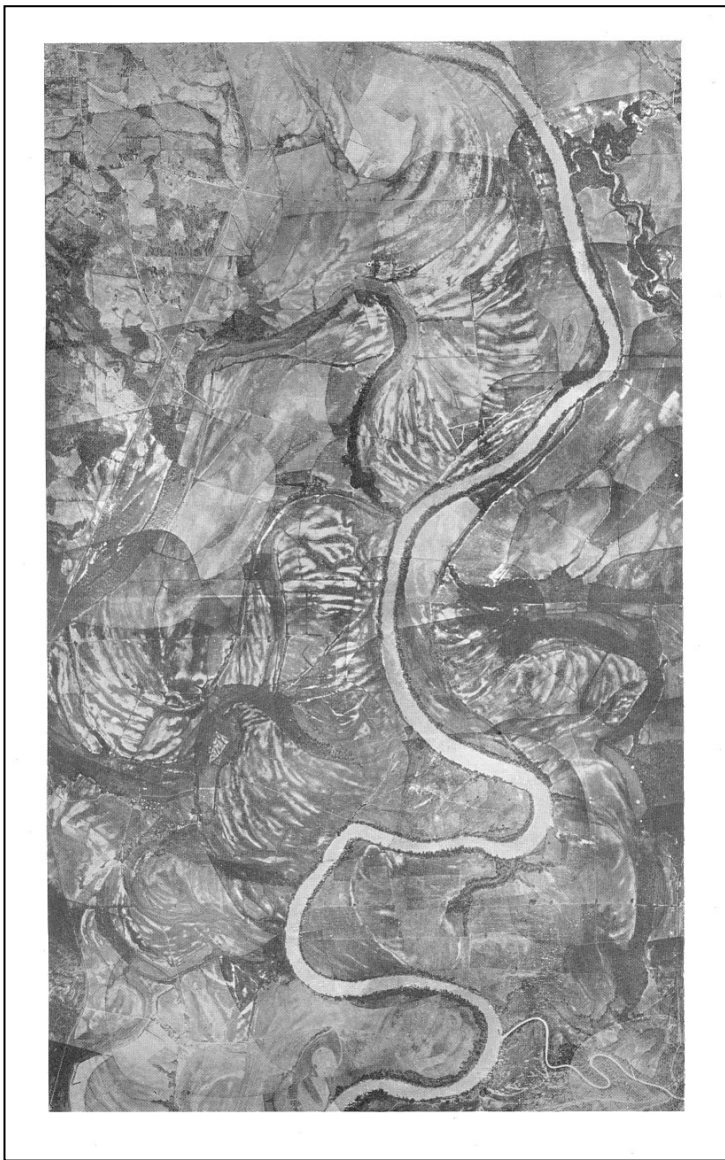

Aerial photos allowed new features to be seen or “sensed”, which had never been mapped previously. The photo at left was imaged in 1922.



- Early airborne cameras used by the military were hand held, using increasing focal lengths to excerpt ground details



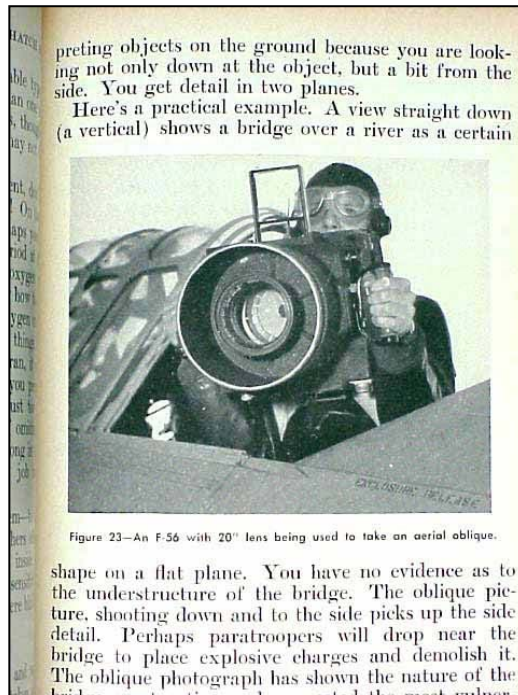
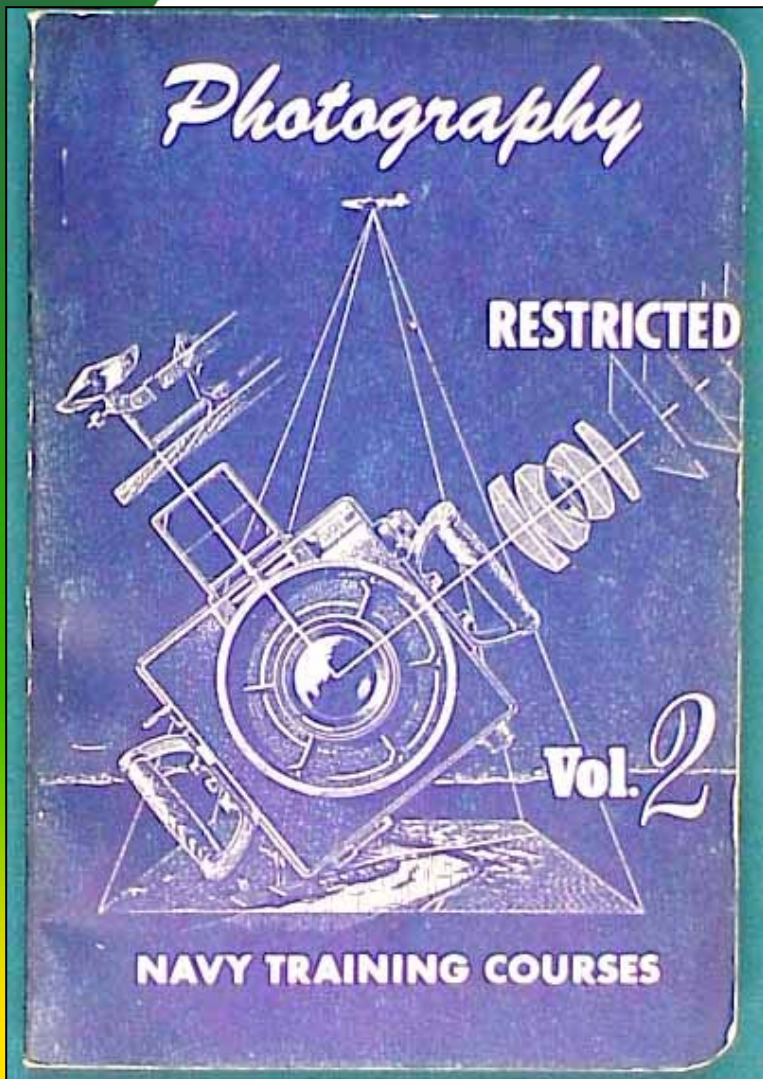

Figure 23—An F-56 with 20" lens being used to take an aerial oblique.

shape on a flat plane. You have no evidence as to the understructure of the bridge. The oblique picture, shooting down and to the side picks up the side detail. Perhaps paratroopers will drop near the bridge to place explosive charges and demolish it. The oblique photograph has shown the nature of the



CHAPTER 5
STEREOSCOPY—DEPTH IN PICTURES
WHAT A RELIEF!

Close one eye. You still see "depth." Whatever you are looking at still appears to have not only height and width but the third dimension too.

Actually, however, you only THINK you see depth with one eye. It takes TWO EYES for you to visualize a ball as a sphere instead of a flat circle. You say things don't look flat to you with one eye? That's because your brain is on the job. Vision with two eyes is such a habit that your memory has stored up an impression of the shape of objects. In a sense, you

Thousands of servicemen were trained in the use of aerial photography during the Second World War, all of which was accomplished with visual sighting, usually requiring clear weather and sunlight over the targets.

Graflex K-20 aerial camera



- The Graflex K-20 hand held aerial camera was mainstay reconnaissance camera used by Allied forces during World War II. It could image 100 frames of 9" x 9" negative frames in a single in a magazine roll, though 50 was the more usual figure.

The Norden Bombsight was intended to allow precision daylight bombardment of strategic targets from an altitude above 20,000 feet

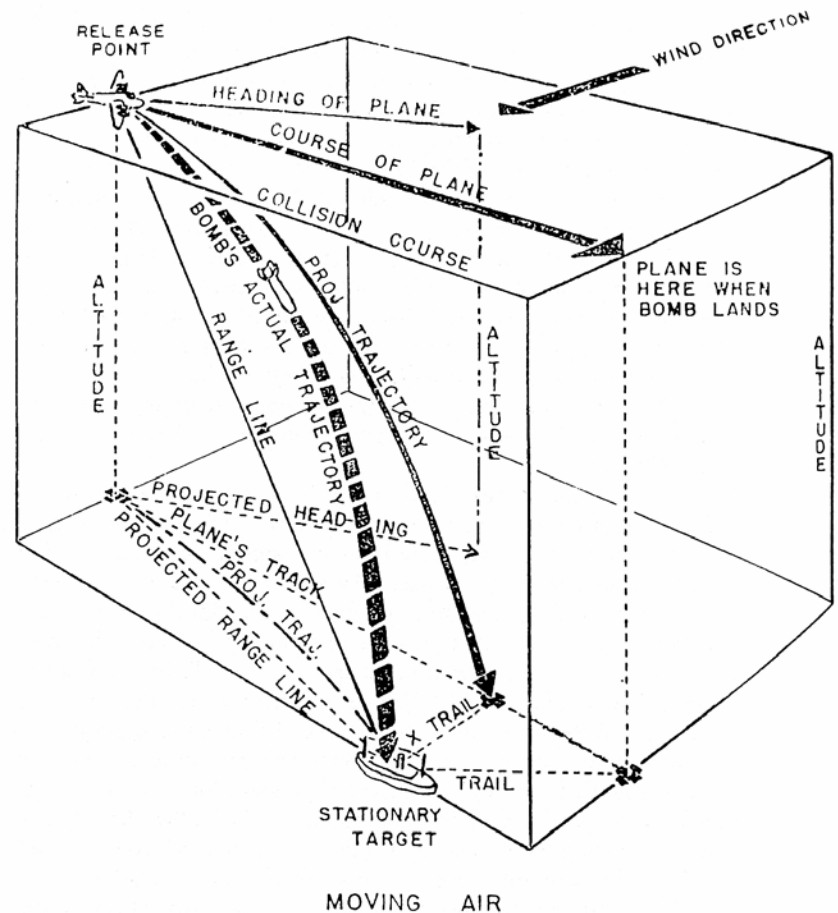



**Northern Europe
was often obscured
by cloud cover,
making visual
bombing difficult**

**View at left shows
Berlin on March 6,
1944, Black Monday**

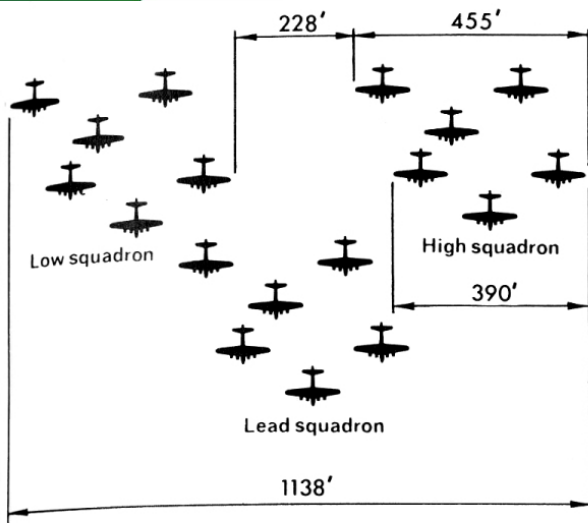

3-view of
MORE COMPACT GROUP
FORMATION - April 1943

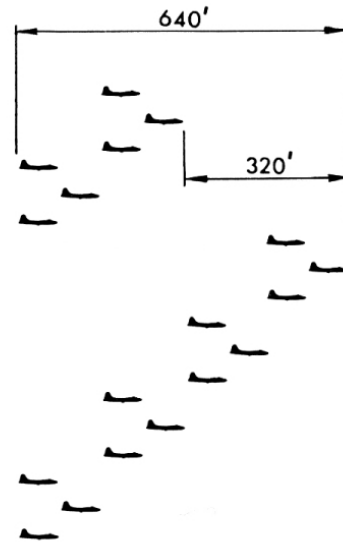
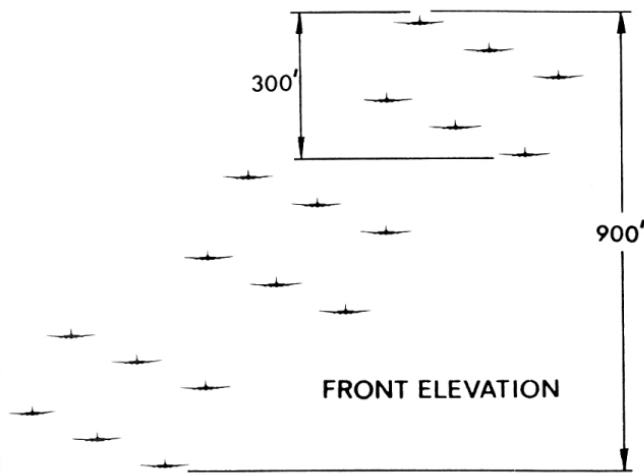

- American bombers flew in compact combat box formations to provide for mutual protection from enemy fighters and place each aircraft at a different altitude



- On long range missions on specific targets the attacking aircraft would image oblique strike photos like that at right, to assess targeting accuracy. This allowed mission planners to decide if subsequent strikes were necessary without dispatching a reconnaissance aircraft

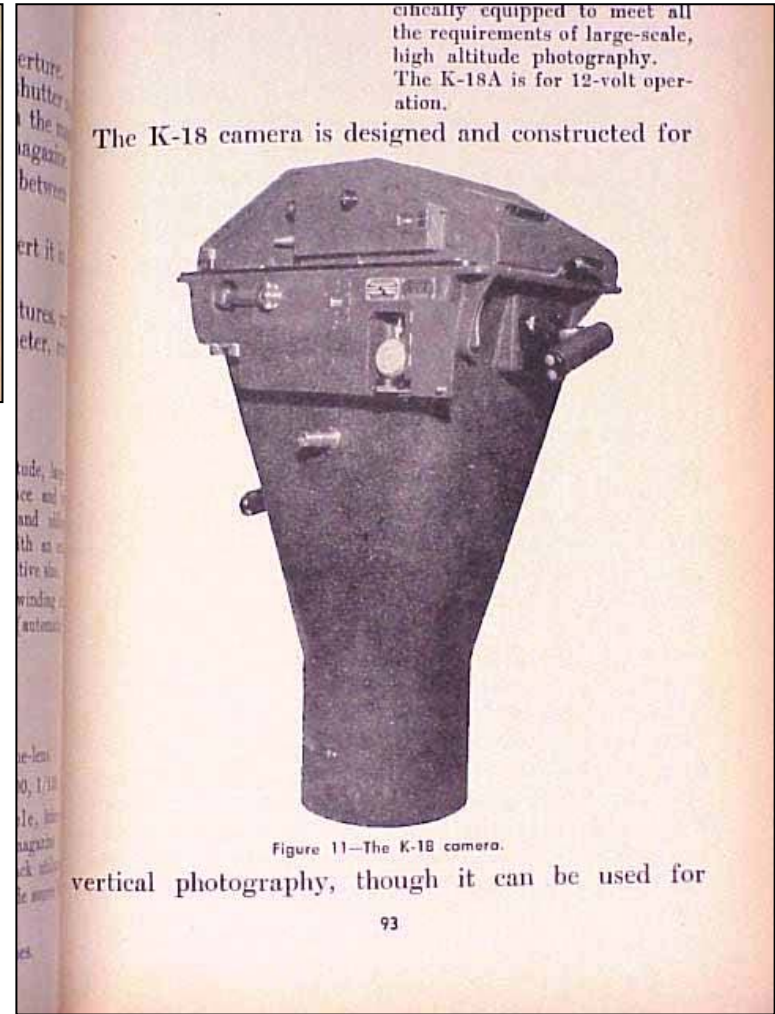

- As production demands increased fixed cameras were employed in specially equipped reconnaissance aircraft, with vertical cameras set on gimbals and oblique cameras for low level, high-speed imagery

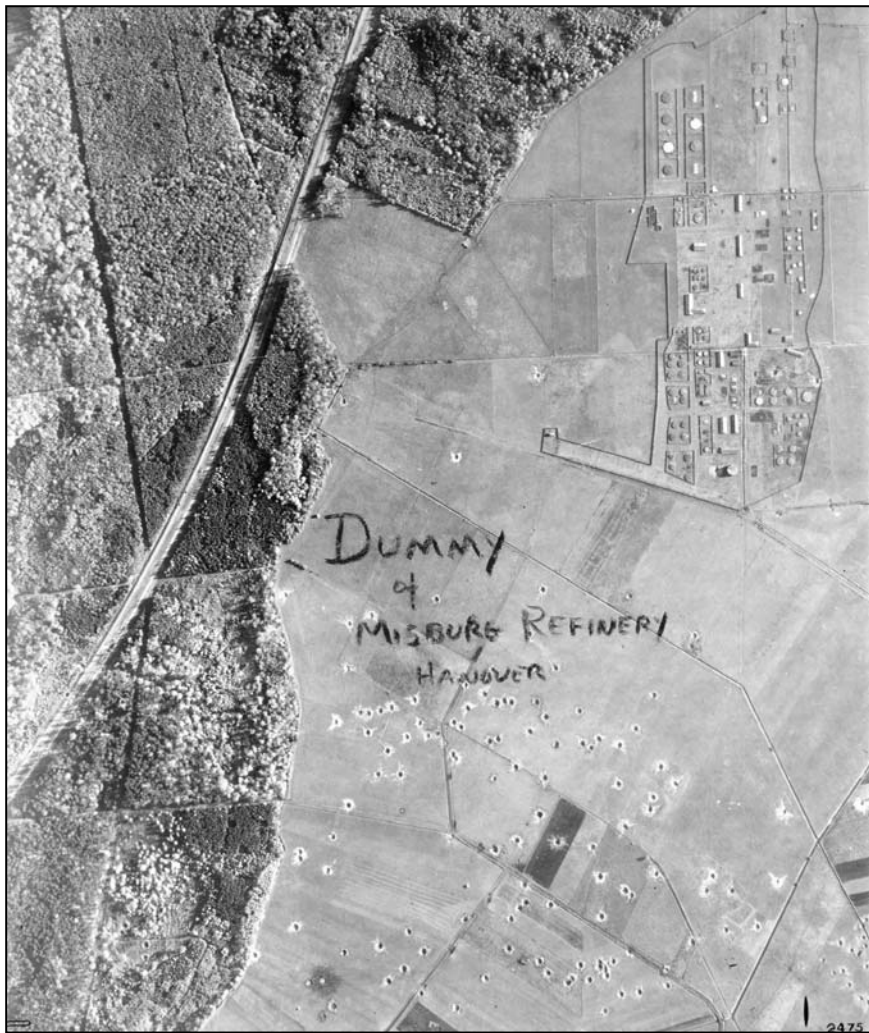

Deceptions such as dummy refineries were commonplace during World War II, designed to fool bomber navigators during missions. As the war progressed, high value targets usually rated low level scrutiny, as shown at right, to check target validity and bomb damage assessment.



- A major part of aerial reconnaissance was Bomb Damage Assessment (BDA) by Operations Analysts (OA's). The percent destruction would be estimated from these images and decisions made about the priority for future strikes



■ Major German cities and industrial centers were obliterated by Allied aerial bombardment, which started enormous fires that destroyed large tracts of structures, as shown at right. Bomb Damage Assessment became increasingly difficult as damage mounted.

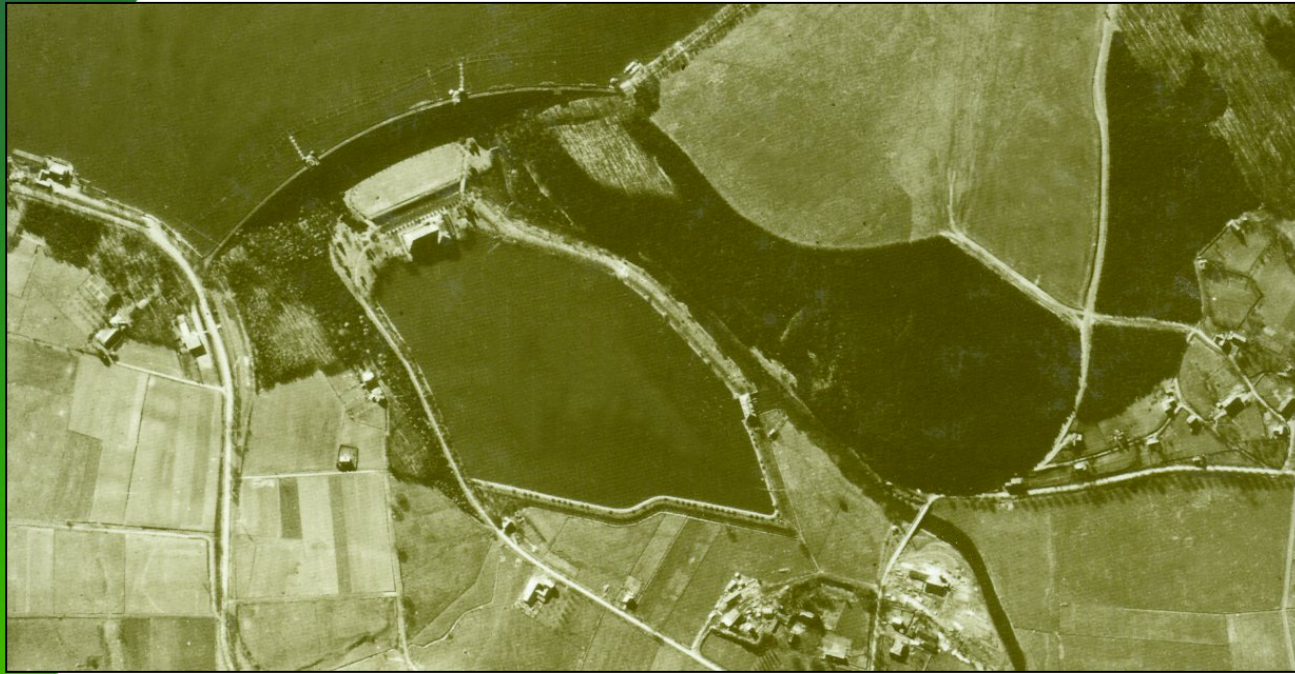

**Bomb Damage
Assessment on the
Mohne Dam in the
Ruhr Valley
following the
dambusters raid of
May 16-17, 1943**

**These are high
level daylight
images, taken from
a long range
DeHavilland Photo
Mosquito**





All of Germany's major cities were razed by Allied bombing; by the Royal Air Force at night and by the Americans during daylight. After February 1, 1945 there were few remaining strategic targets, so the Americans began joining the British in massive air armadas bombing cities such as Dresden.





American B-29 bombers rained down destruction on major Japanese cities during a 10 month aerial siege between mid Sept 1944 and early August 1945. Fire bombings killed as many as 140,000 in a single night in Osaka. Japanese structures were mostly wooden and extremely vulnerable to fire.

STATION	CAMERA	FOCAL LENGTH-INCHES	QUANTITY	USE
Triangulation	K-17C	6	3	Charting and Mapping
Vertical	K-17C, K-37, K-22A, or T-11	6, 12, or 24	1	Mapping, Intelligence, and Night Photography
Split Vertical	K-38	24	2	Mapping, Reconnaissance, and Intelligence
Multi	K-38 or K-40	36 48	5	Reconnaissance and Intelligence
Forward Oblique	K-22A	12	1	Reconnaissance and Intelligence
Left Oblique	K-22A	12 or 24	1	Reconnaissance and Opportunity
Right Oblique	K-22A	12 or 24	1	Reconnaissance and Opportunity
Photo-Navigator and Radar Observer	C-1		2	Radar Scope Photography
Photo-Navigator	A-6		1	Motion Picture Reconnaissance and Intelligence



Comparison of camera types and focal lengths widely employed during World War II. Most systems were equipped with focal lengths between 6 and 24 inches, though some cameras with 60 inch focal lengths were used sparingly, as shown above

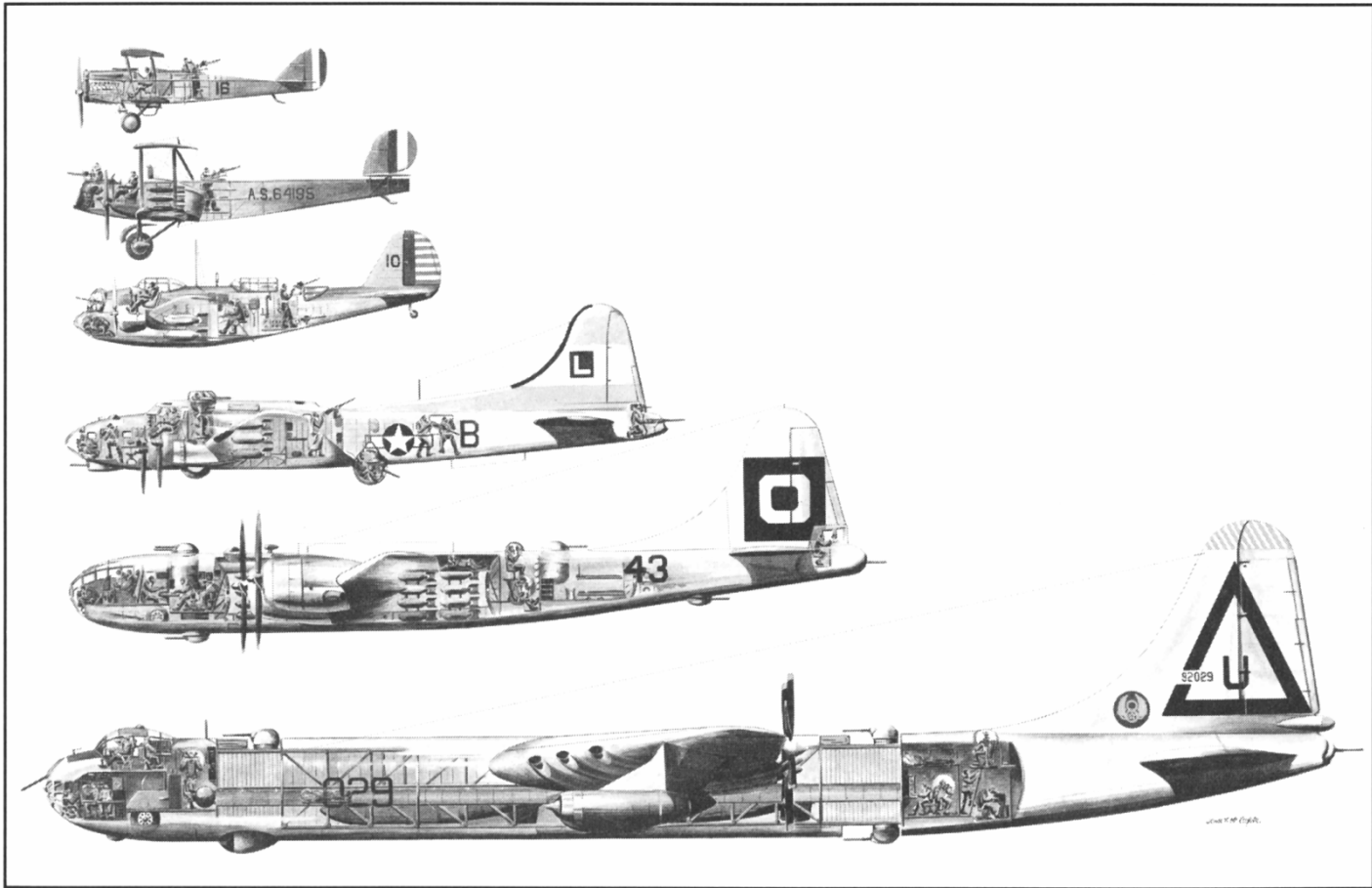

- **Progression of American bombers between 1917 and 1949; all of these were employed in reconnaissance roles, given F designations.**



- The World's largest aerial camera was the Boston Camera deployed on the RB-36 Peacemaker in 1951. It weighed 6,500 pounds



■ **The Boston Camera used an f/8 lens with a focal length of 240 inches (20 feet), made possible by two mirrors, using a shutter speed of 1/400 second. It could photograph a golf ball from an altitude of 45,000 feet, well above enemy interceptors.**