

**BRIEF OVERVIEW**

**MILITARY APPLICATIONS**

**OF**

**UNDERGROUND**

**OPENINGS**

J. David Rogers, Ph.D., P.E., P.G.  
Karl F. Hasselmann Chair in Geological Engineering  
Missouri University of Science & Technology  
for

**Department of Geography & Environmental Engineering**

**United States Military Academy, West Point, NY**

**Wednesday May 4, 2011**

# HISTORIC EXAMPLES

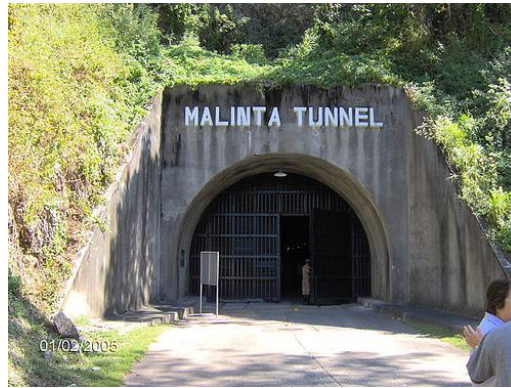
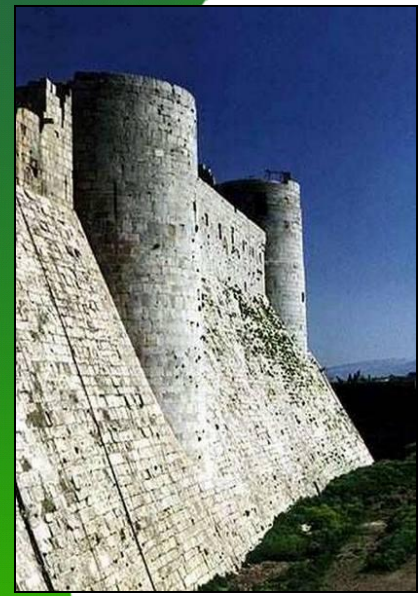

- Sappers used to penetrate medieval castles, resulting in perimeter moats
- Crater tunnels excavated during American Civil War and First World War
- Sewer systems utilized by insurgents in Warsaw Ghetto during WW2
- Bataan Peninsula Redoubt WW2
- German aircraft production moved below ground during WW2

# HISTORIC EXAMPLES

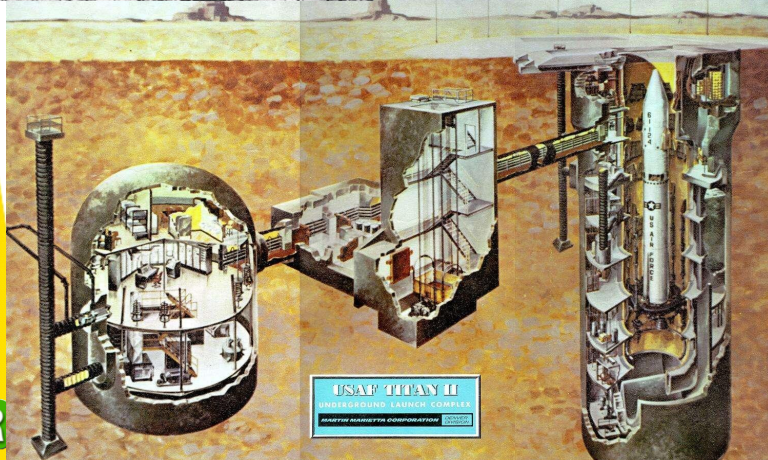
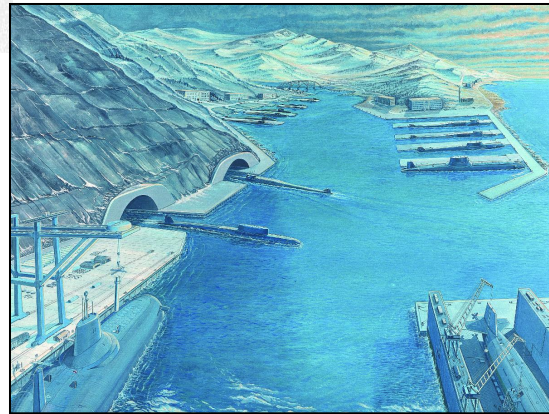
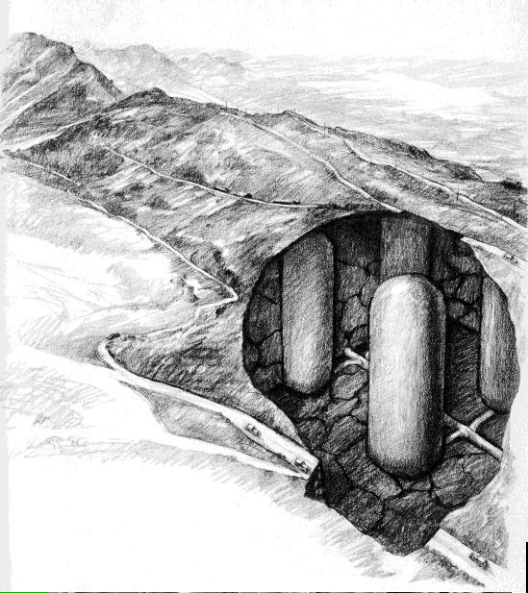

- **Underground POL storage at Pearl Harbor**
- **Strategic POL reserve excavated by Japan**
- **Hardened sites excavated by former Soviet Union to protect high value targets**
- **Silos for ballistic missile complexes**
- **North Korean infiltration tunnels**
- **Tunnels of Cu Chi in Iron Triangle of South Vietnam**
- **Caves used by Mujahideen in Afghanistan**
- **Underground nuclear waste storage**

# Water Supply Infrastructure



- ***Ancient Jerusalem*** was equipped with a more defensible water supply to withstand siege warfare in 700 BC

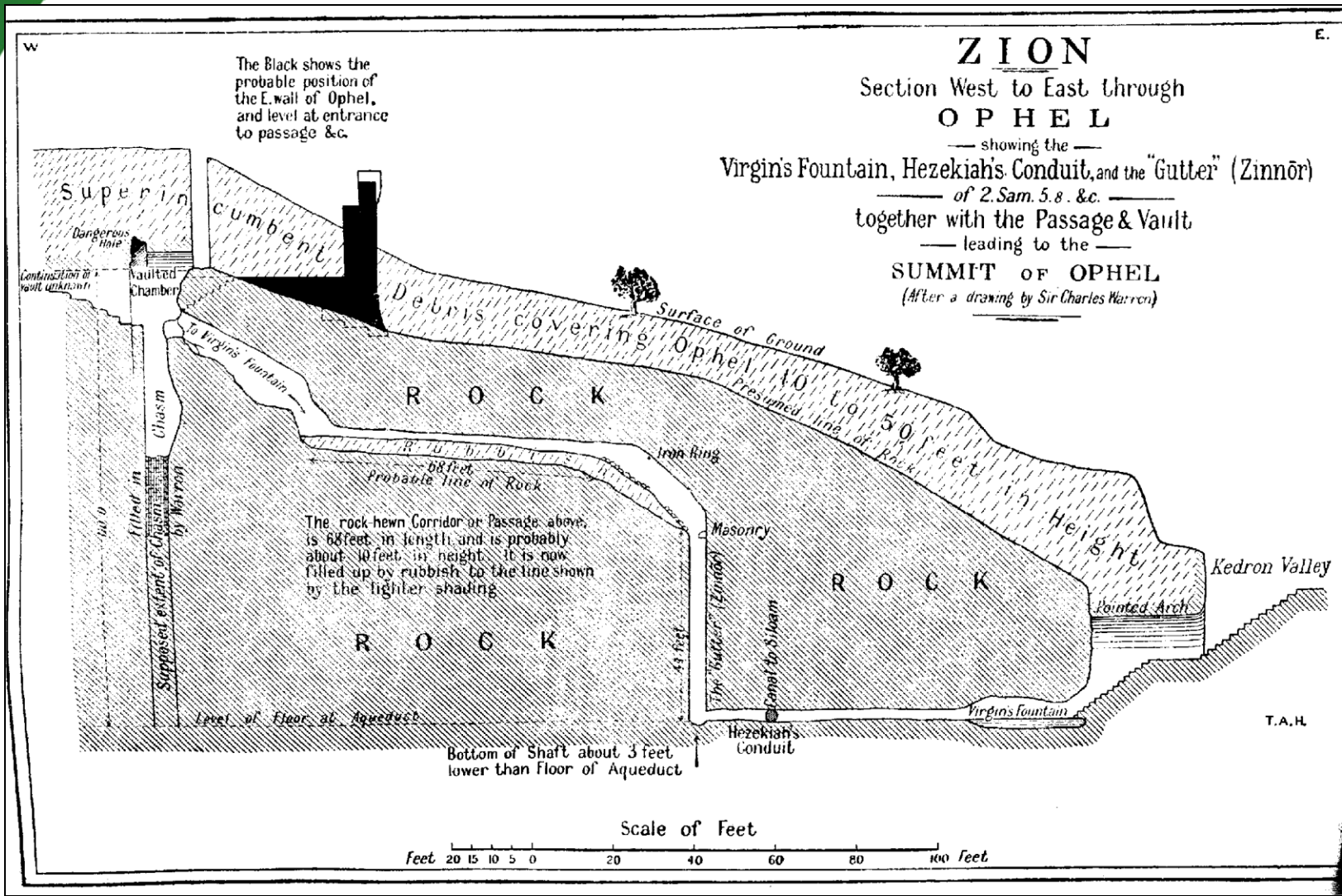

- **Warren's Shaft** was discovered in 1867. The shaft allowed water from the Gihon Spring to be accessed from behind the walls of Jerusalem

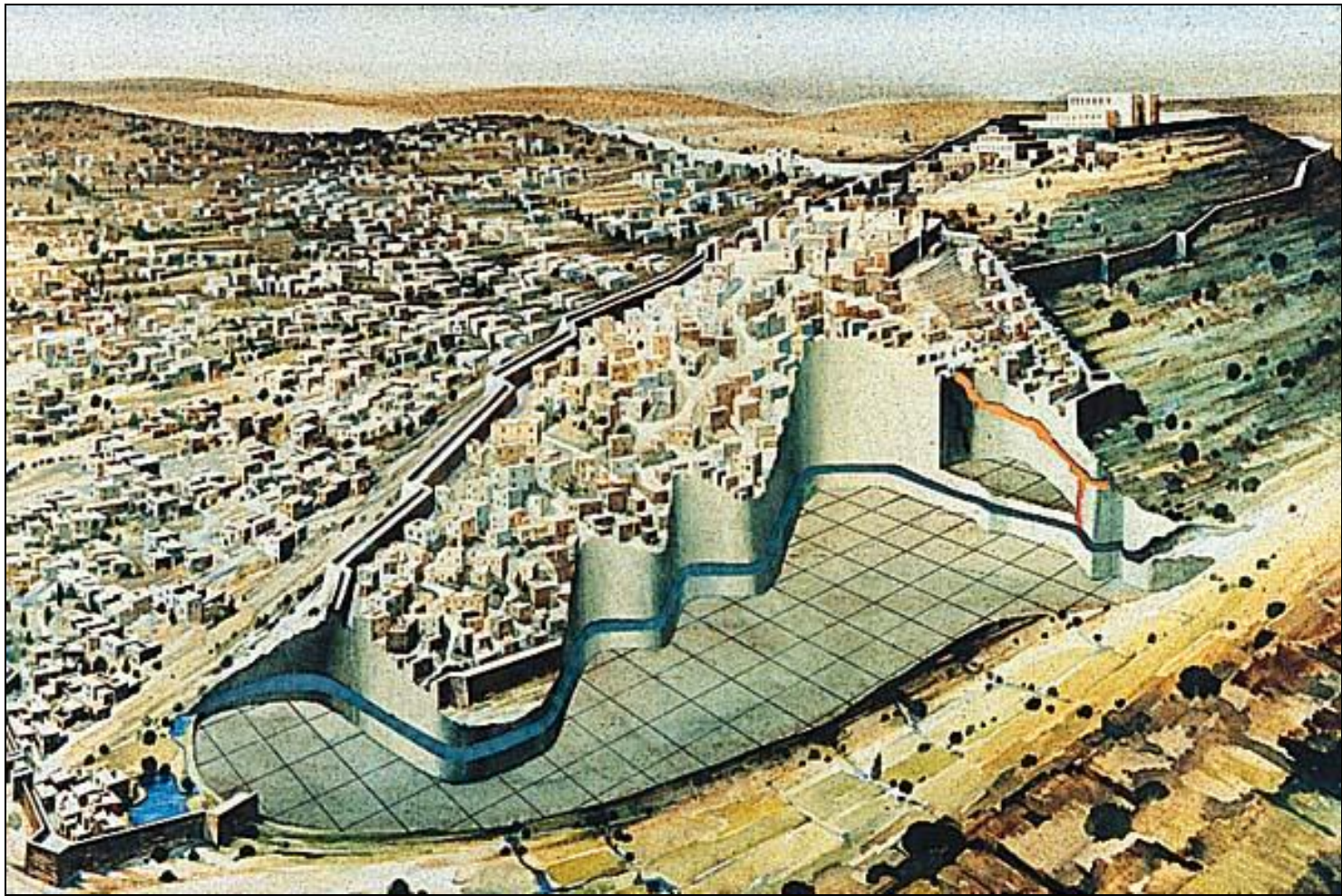

- ***Hezekiah's Tunnel*** was excavated from both portals simultaneously when Jerusalem was threatened by an Assyrian siege.

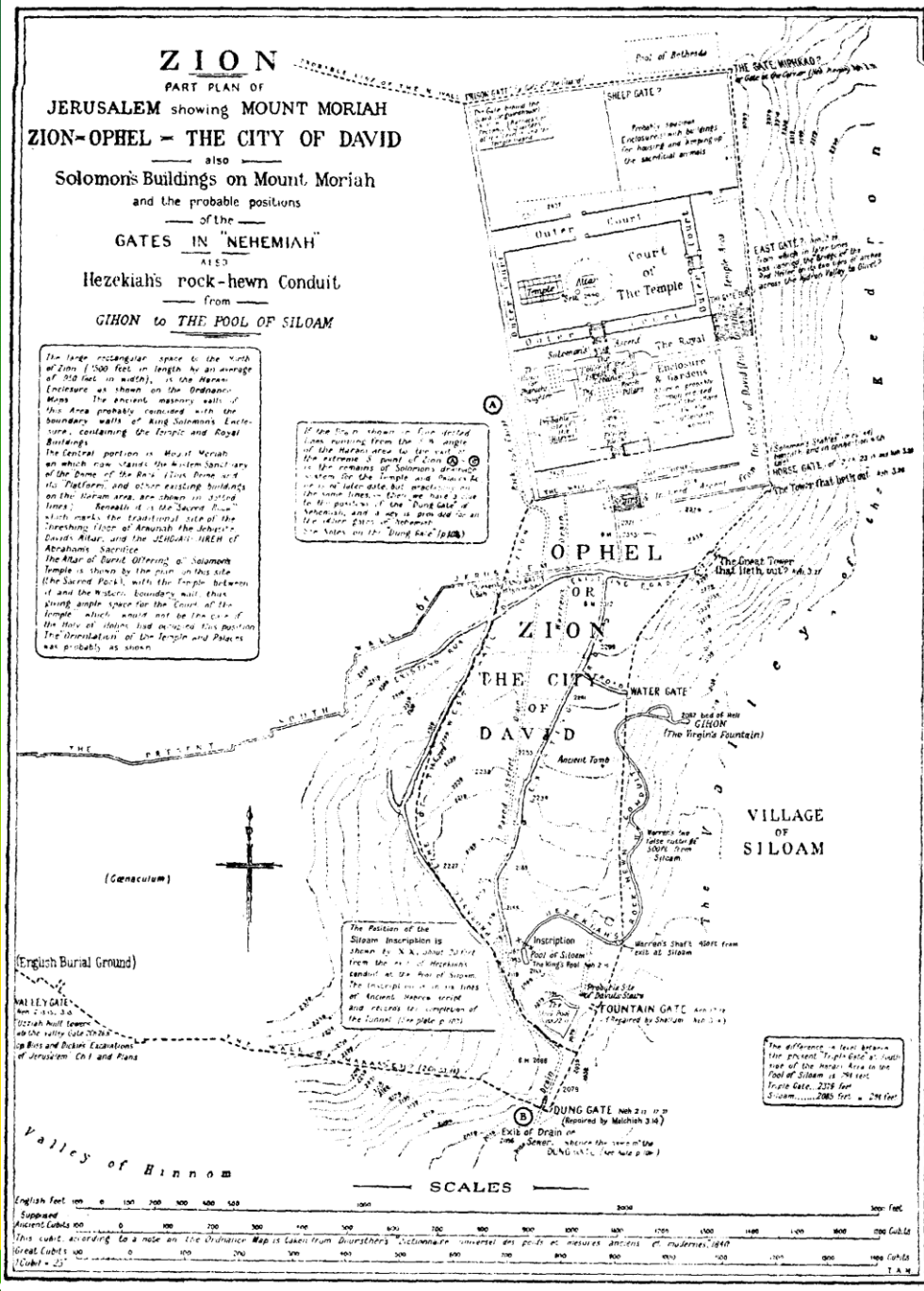

- **Hezekiah's Tunnel** was re-discovered by British explorer Edwin Robinson in April 1838 as part of the English **Palestine Exploration Fund**.
- The tunnel is 1750 feet long between the **Gihon Spring** in the Kidron Valley and the **Pool of Siloam**, inside the old city wall.

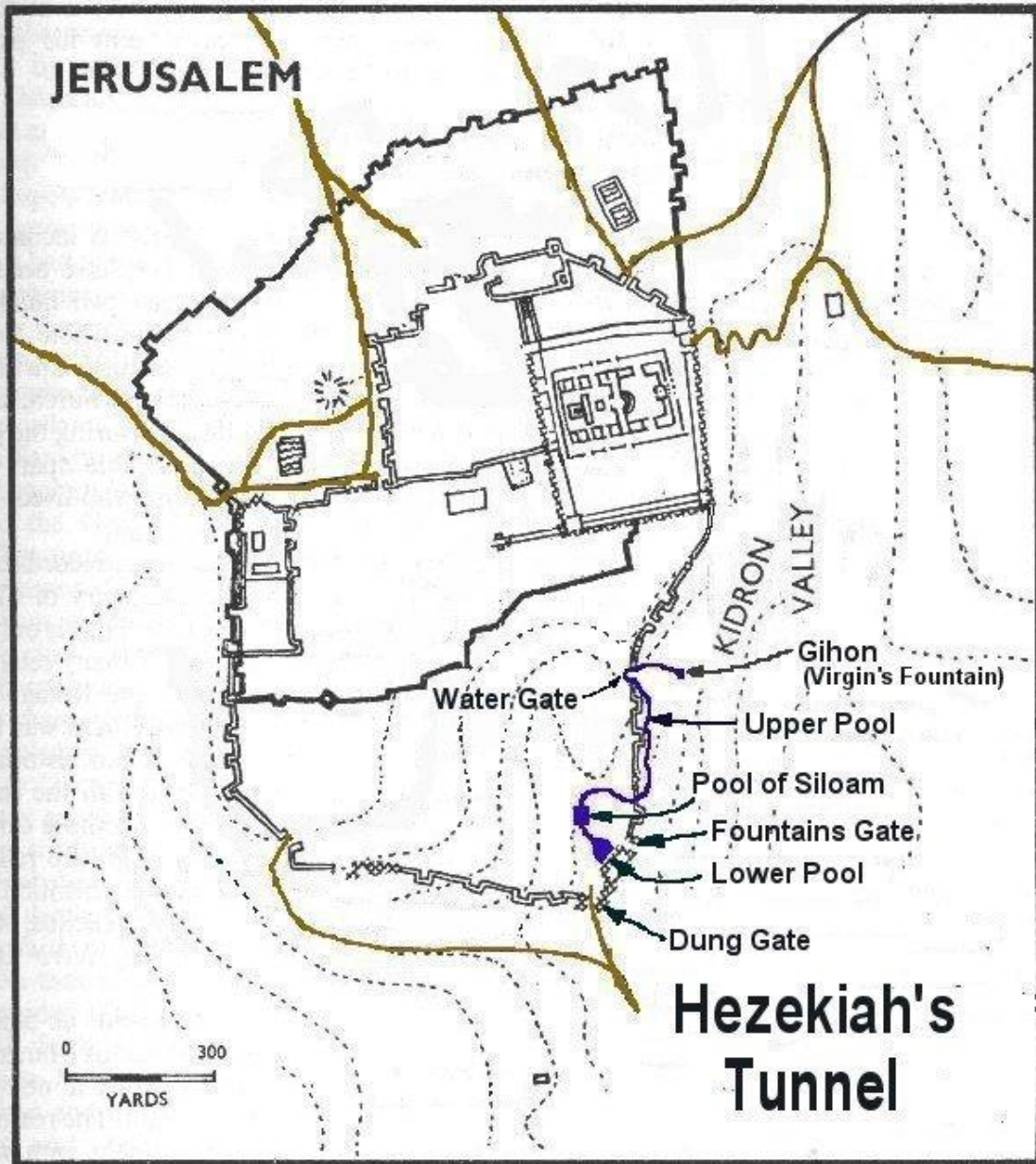

- According to scriptures, the water supply tunnel was excavated during the reign of Israeli King Hezekiah in 701 BC
- Note serpentine path, following solution cavities in the limestone



# Hezekiah's Tunnel - 701 BC

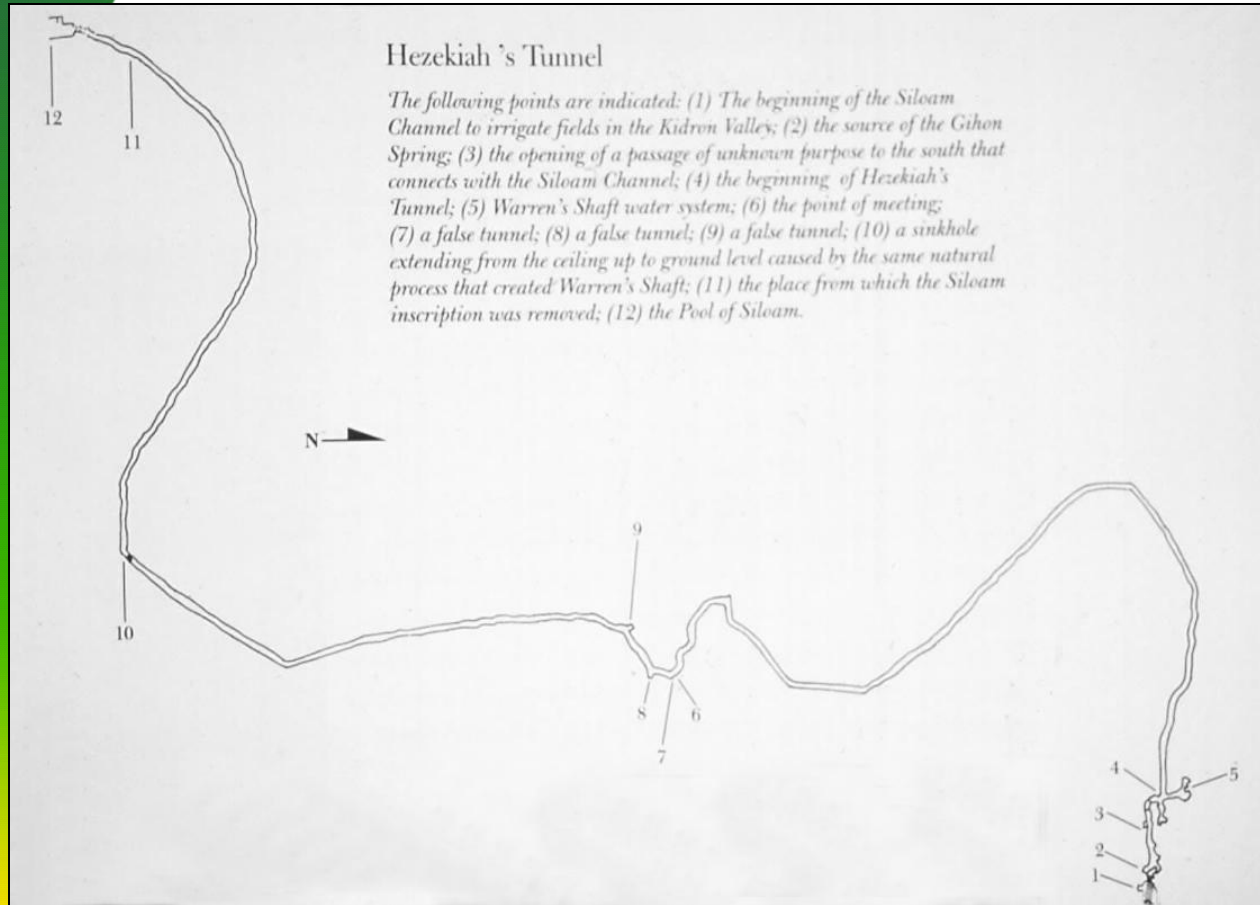

The tunnel was re-discovered by Edwin Robinson in 1838, but the **Siloam Inscription** was not discovered at the meeting point until 1880. It was removed in pieces from the tunnel in 1891 and taken to the Istanbul Archaeology Museum. The tunnel was cleared by Montague Parker's team in 1909-11, and cleaned out again by Israeli archaeologists in 1973, and a replica of the inscription was inserted into the tunnel in 2010.



# Siloam Inscription

- **The Siloam Inscription was discovered by two boys in 1880 about 20 feet in from the tunnel's mouth in the Pool of Siloam. It reads:**
- *"[...when] (the tunnel) was driven through. And this was the way in which it was cut through: - - while...] (were) still [...] axes (s) , each man toward his fellow, and while there were still three cubits to be cut through, [there was heard] the voice of a man calling to his fellow, for there was an overlap in the rock on the right [and on the left]. And when the tunnel was driven through, the quarrymen hewed (the rock), each man toward his fellow, axe against axe; and the water flowed from the spring toward the reservoir for 1,200 cubits and the height of the rock above the head (s) of the quarrymen was 100 cubits."*
- **This suggests that the miners used acoustic methods to approach one another's tunnels from opposing headings**



- **Ancient cities were usually equipped with buried water supply and storage systems to enable survival under sieges. Nebuchadnezzar's unsuccessful siege of Tyre lasted 15 years, between 586 and 571 BC.**



- **The ancient tell of Megiddo is typical of fortress cities throughout antiquity, with a stone-faced glacis, main entry gate with multiple guard towers, commanding view of the surrounding country and a siege-proof source of water.**

# MEGIDDO WATER TUNNEL



- **2800 years ago King Ahab excavated a secure water supply by excavating a 390-ft long tunnel to the natural springs along the Mt. Carmel fault that lay outside the city walls. The entry shaft (at left) was 200 feet deep.**

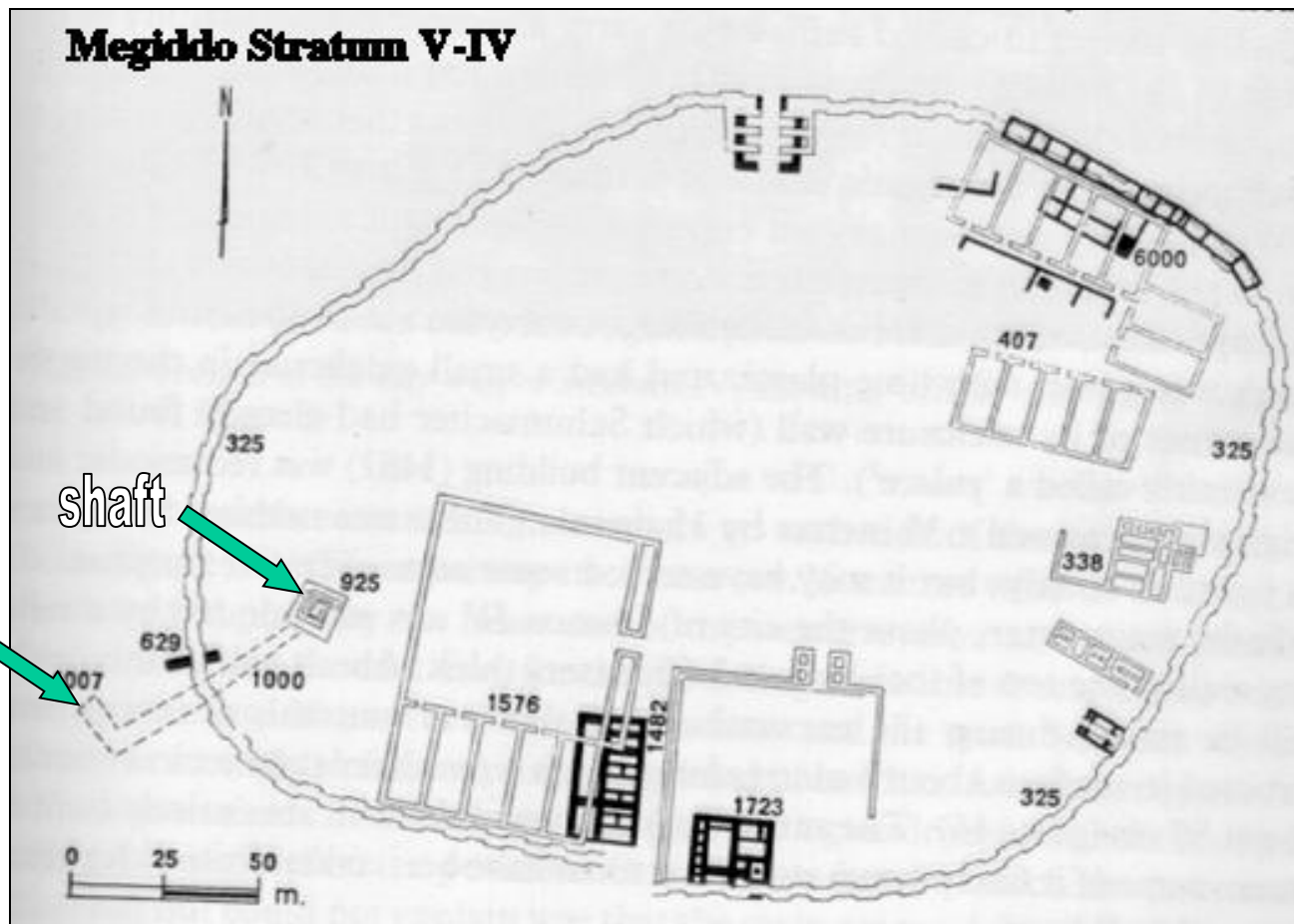

- Megiddo's spring (arrow) is located on a splay of the ***Carmel-Gilboa fault***, a left-lateral feature extending northwesterly from the Dead Sea Rift that is believed to have destroyed Megiddo on at least three occasions.

# Alexander's Seven Month Siege of Tyre

## Nov 333 to Aug 332 BC

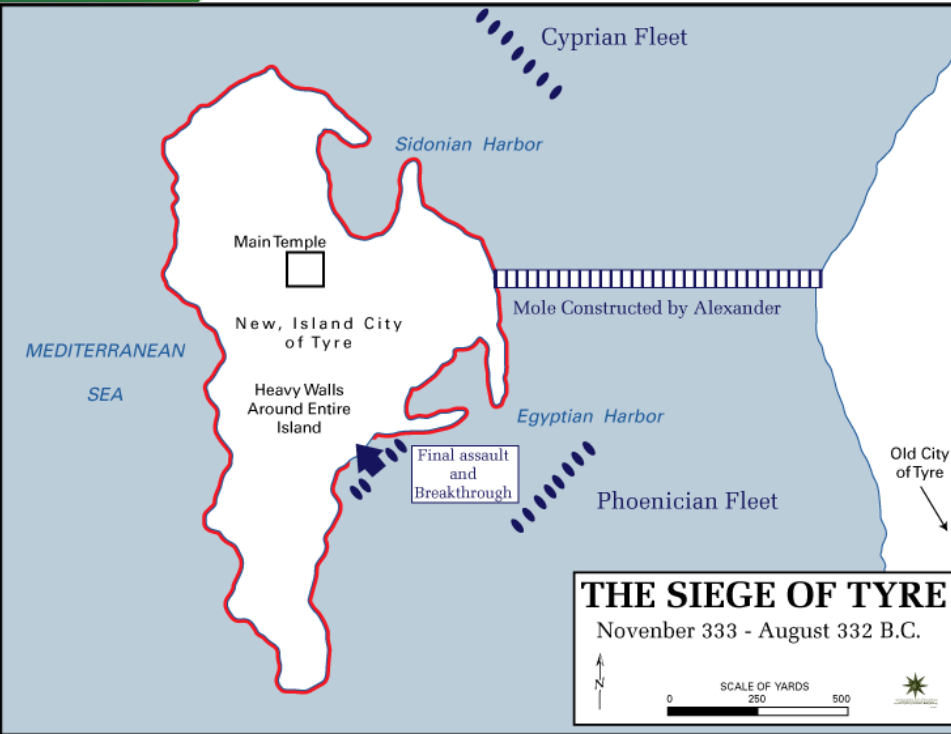

- At the time of Alexander's siege, Tyre held approximately 40,000 people, though the women and children were evacuated to Carthage. As Alexander did not have much of a navy, he resolved to take the city and thus deny the Persians their last harbor in the region. After months of trying to capture Tyre the Persian fleet surrendered about 332 BC. This enabled Alexander to attack from all sides.
- Alexander built a causeway one kilometer long on a tombolo feature about 2 m below mean sea level. This mole allowed his artillery to get in range of the walls, but the water became deeper, and the counterattacks from the walls and the Tyrian navy slowed progress to a crawl.

# The Tyrians Win Round 2



- Alexander constructed two siege towers 160 ft high and placed them to the end of his mole. These towers employed catapults to bombard the parapets and ballistas to hurl stones at attacking ships. The towers were sheathed in rawhide to protect them from fire arrows.
- The Tyrians quickly devised a counterattack, filling an old horse transport ship with dried branches, pitch, sulfur, and other combustibles. They then hung cauldrons of oil from the masts, so that they would fall onto the deck once the masts burned through. They also placed ballasts in the ship's stern to raise its bow above the water. They then lit it on fire and ran it up onto the causeway. The fire spread quickly, engulfing both towers and other siege equipment that had been brought up.
- The Tyrian ships swarmed the pier, destroying any siege equipment that hadn't caught fire, and driving off Macedonian crews that were trying to put out the fires.





# Forced to engage in a naval battle

- After the defeat of his massive siege towers by the Tyrian's fire ship, Alexander realized that he would not be able to take Tyre without a navy.
- When the Persian Navy attempted to return to their home ports, they found they were under Greek control. The Persians' allegiance to their cities allowed Alexander to find himself in command of 80 ships, which coincided with the arrival of another 120 ships from Cypress and an additional 23 ships, all of whom wished to share in the plunder of Tyre. Alexander thus found himself in command of no less than 223 galleys.
- Alexander blockaded the Tyrian ports, and began fitting some of his slower ships with battering rams. Finding that large underwater blocks of stone kept the rams from reaching the walls, Alexander had them removed by crane ships. The rams then anchored near the walls, but the Tyrians sent out ships and divers to cut the anchor cables. Alexander responded by replacing them with chains.

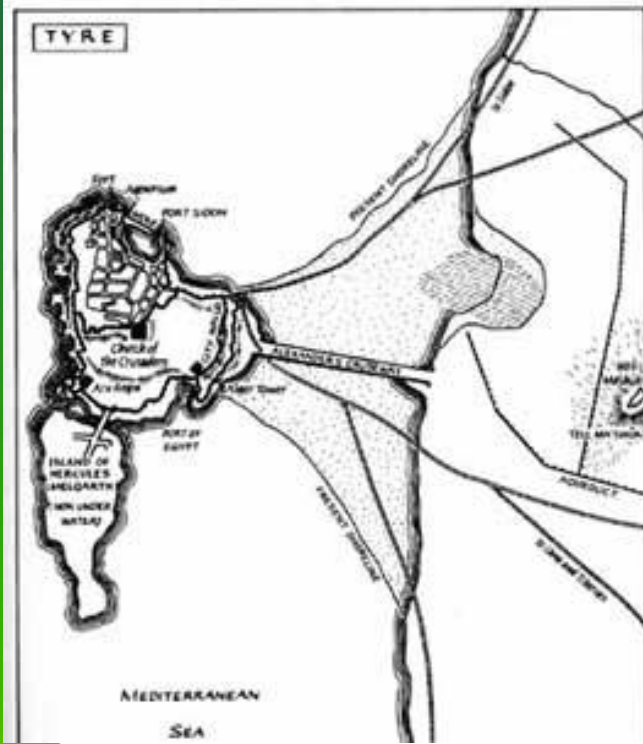

# Conclusion of the Siege of Tyre

- Alexander started testing the wall at various points with his rams, until he made a small breach in the south end of the island. He then coordinated an attack across the breach with a bombardment from all sides by his navy. Alexander is said to have personally taken part in the attack on the city, fighting from the top of a siege tower.
- Once his troops forced their way into the city, they easily overtook the garrison, and quickly captured the city.

■ 6,000 fighting men were killed within the city and 2,000 Tyrian men were crucified on the beach. The others, some 30,000 people, mostly women and children, were sold into slavery. The severity of reprisals were both because of the length of the siege, and because the Tyrians had executed some captured soldiers on the walls, in view of the attackers.

■ The lessons drawn from the Siege of Tyre were taught to all Roman officers a few centuries later, all of whom were trained as engineers. These lessons were that military engineering, protection of one's flanks, a sustainable chain of supply, the ability to counter new threats with flexible response, and the staying power of sheer tenacity, could be combined to defeat a well-entrenched and confident foe.

# More robust and resilient fortifications

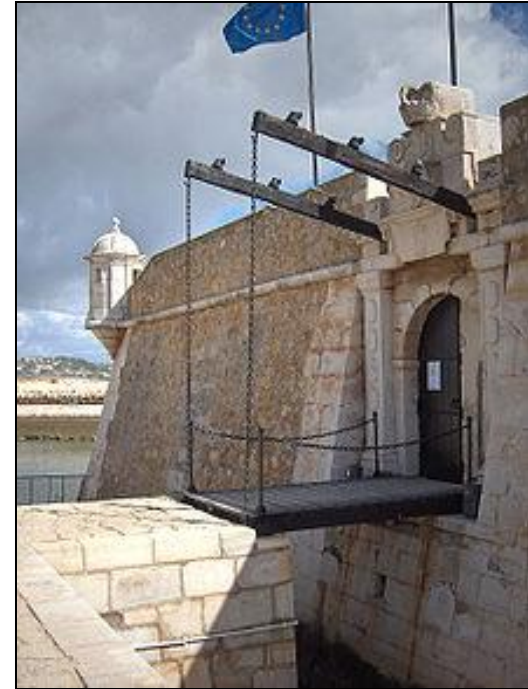

During the post-Crusader period (1187 to 1570 AD) fortifications were equipped with rounded surfaces, deeper moats, higher walls, and drawbridges to better resist sieges



- **Between the Romans and the Renaissance, fortified cities were often built around castles, with multiple lines of defense against attacks by marauding forces, such as the Norsemen, as well as extended sieges.**

# The Crater at Petersburg – July 1864

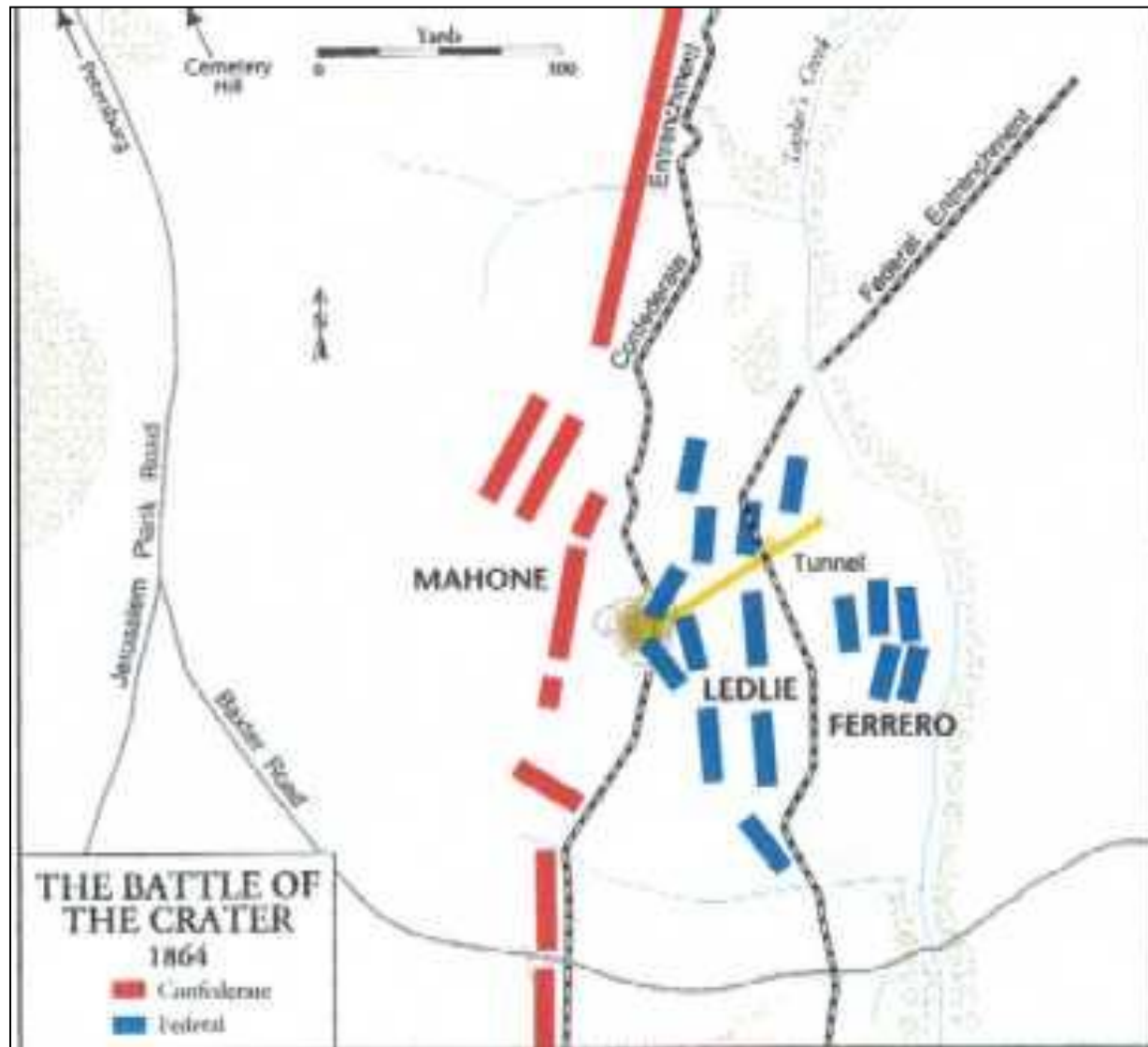

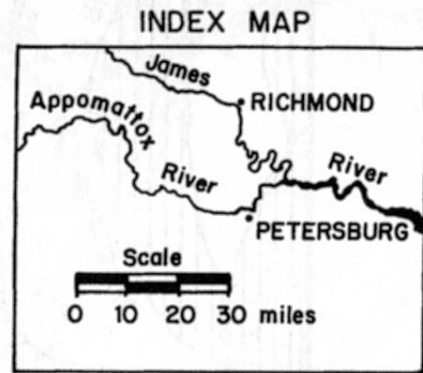
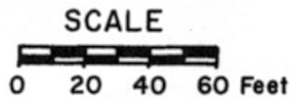
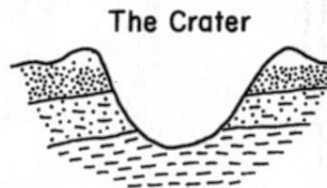
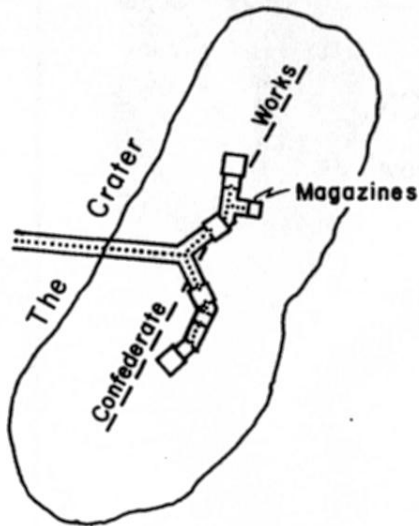

**B.** Tunnel Extentions beneath Confederate Works.  
Explosive Charges formed The Crater July 30, 1864

### EXPLANATION

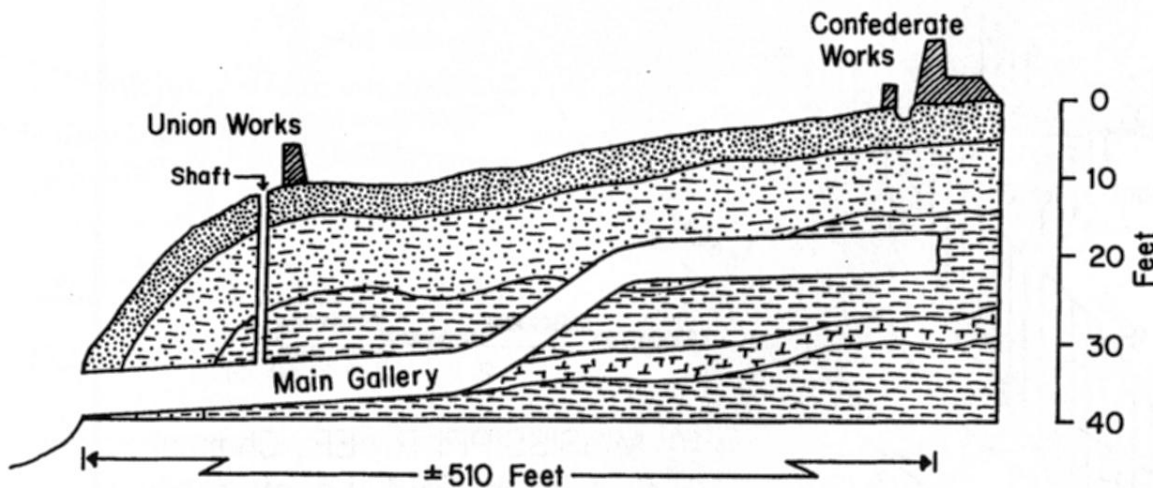
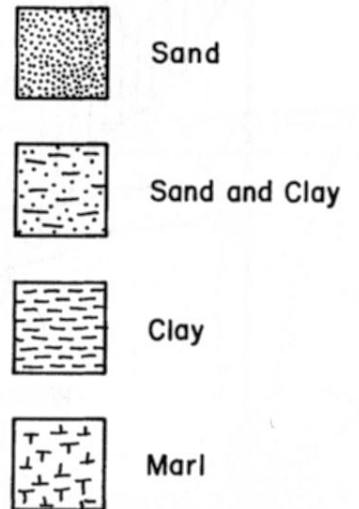

**A.** Geologic Section of Main Gallery – Tunneling beneath  
Confederate Fortifications, Battle of Petersburg  
July 15-23, 1864

Modified after  
J. M. McPherson, 1989  
Figs. II and IV p.61

George A. Kiersch  
1994

- Natural ***lava tubes*** are formed by the withdrawal of molten lava after the formation of a surficial crust.
- Common in Hawaiian and Cascadian volcanic regions
- Captain Jack (Kintpuash or Keintpoos) and his Modocs are hiding in the northeastern California lava beds.

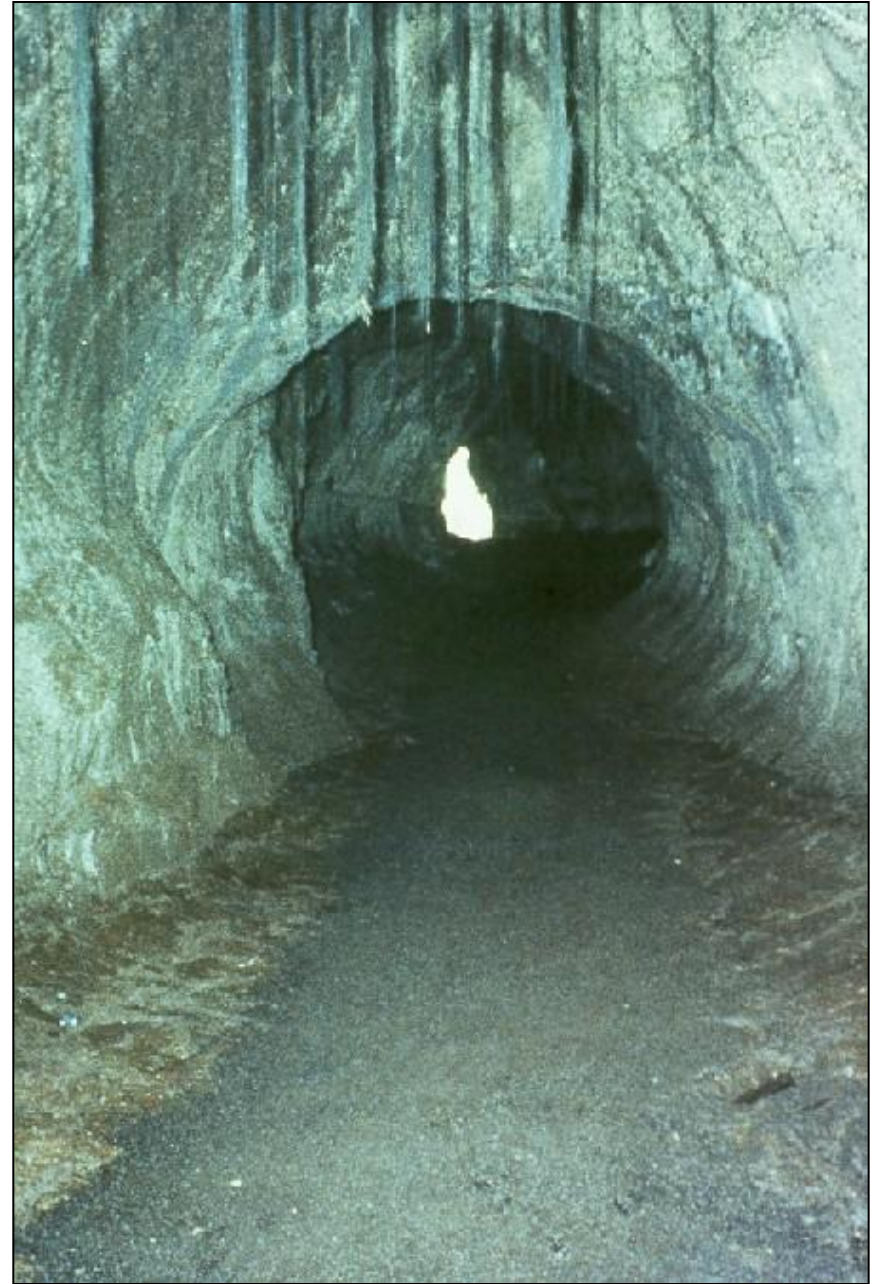
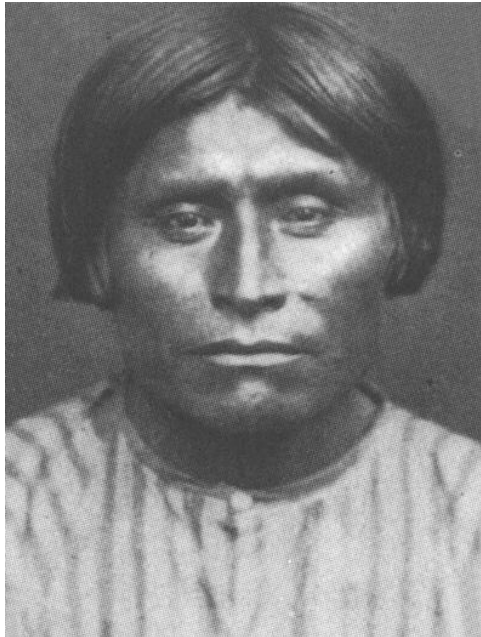

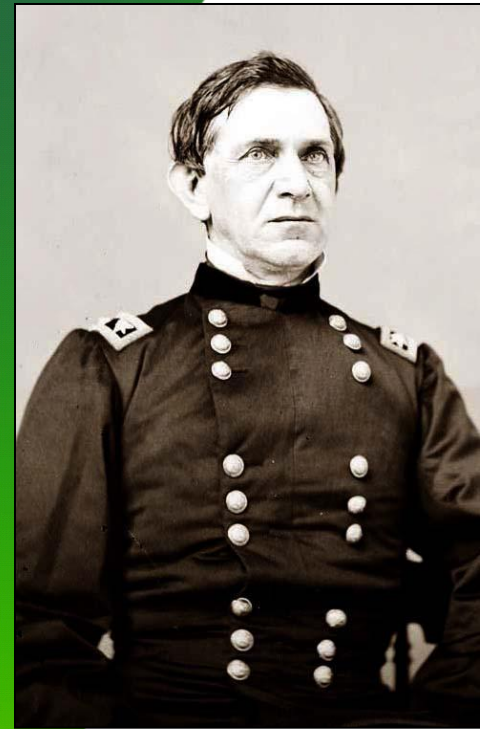

**Major General  
Edward R.  
“Sprigg”  
Canby ( 1817-  
1873)**  
graduated  
from West  
Point in 1839,  
and was the  
highest  
ranking officer  
killed during  
the Indian  
Wars

**LAVA TUBES** are natural  
underground openings  
that can be exploited for  
military purposes

**This map shows the cave  
complex used by the  
Modoc Indians in the  
uprising of 1872-73, in  
which MGEN Canby was**

**UMR** killed

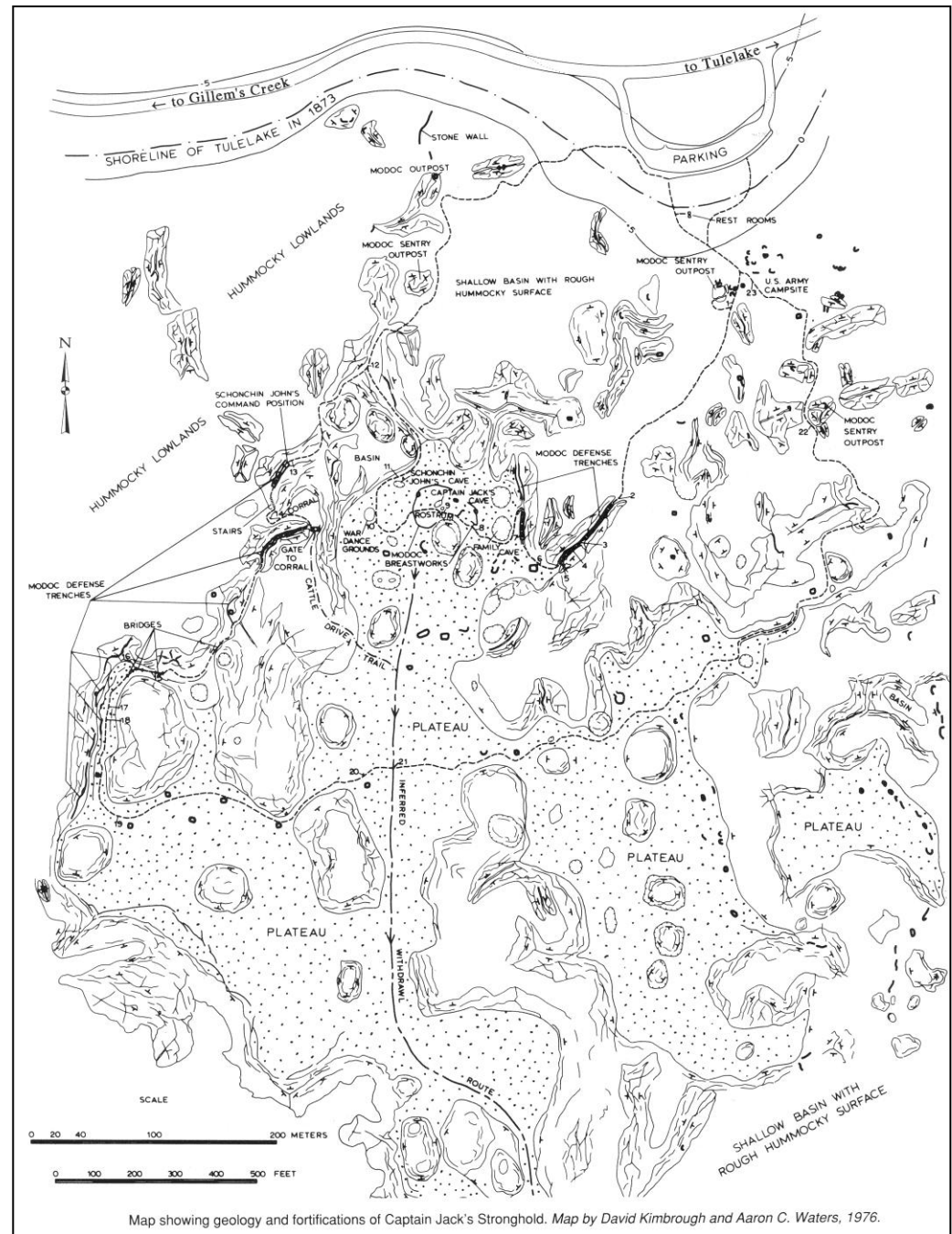

Map showing geology and fortifications of Captain Jack's Stronghold. Map by David Kimbrough and Aaron C. Waters, 1976.





- **The First World War (1914-18) marked the transition between ancient and modern warfare, where technology, wartime production, and logistics emerged as key factors. 4.5 million men died in the 4-year conflict, mostly from artillery and disease.**

# FIRST WORLD WAR ENTRENCHMENTS



**British infantry knee deep in mud.**



**An Australian trench at Messines Ridge.**



**Officers walking through a flooded communication trench.**



**An abandoned German trench at Messines Ridge.**

Aircraft can warn of the build-up of enemy troops before an attack



Concrete block house for a machine-gun

Long-range artillery is placed about 10 km behind the front line. These guns fire at advancing enemy troops

Reserve trench

Support trench

Front-line trench

Barbed wire: metres deep and an impassable obstacle for any troops able to reach it

Communication trenches allow reserves to be brought forward without exposing them to enemy fire

No Man's Land (the stretch of land between the trenches of the opposing sides) has already been churned up by shell fire. In wet weather it becomes a mass of mud, making it even harder for troops to cross

Front-line dug-outs provide protection but not against a direct hit from an artillery shell

A deep dug-out. German ones could be 15 m below ground and too well constructed to be damaged by shell fire

## PROBLEMS FACING ATTACKING TROOPS

# MINES BENEATH ENEMY ENTRENCHMENTS IN WORLD WAR I

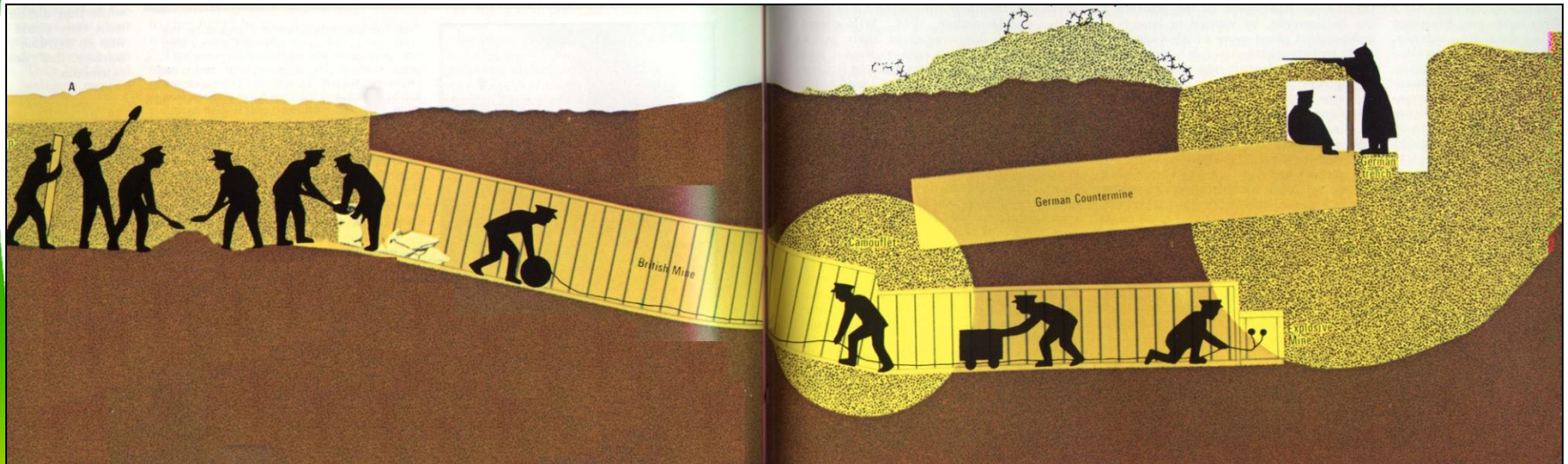

- **Offensive Mining**
  - Schematic section view (not to scale)
  - Anything one side tried that was even marginally successful, was usually tried by the opposing side shortly thereafter

# Mines on the Western Front 1914-18

- **Defensive Mining**
  - **Geophone**
  - **Camouflet**

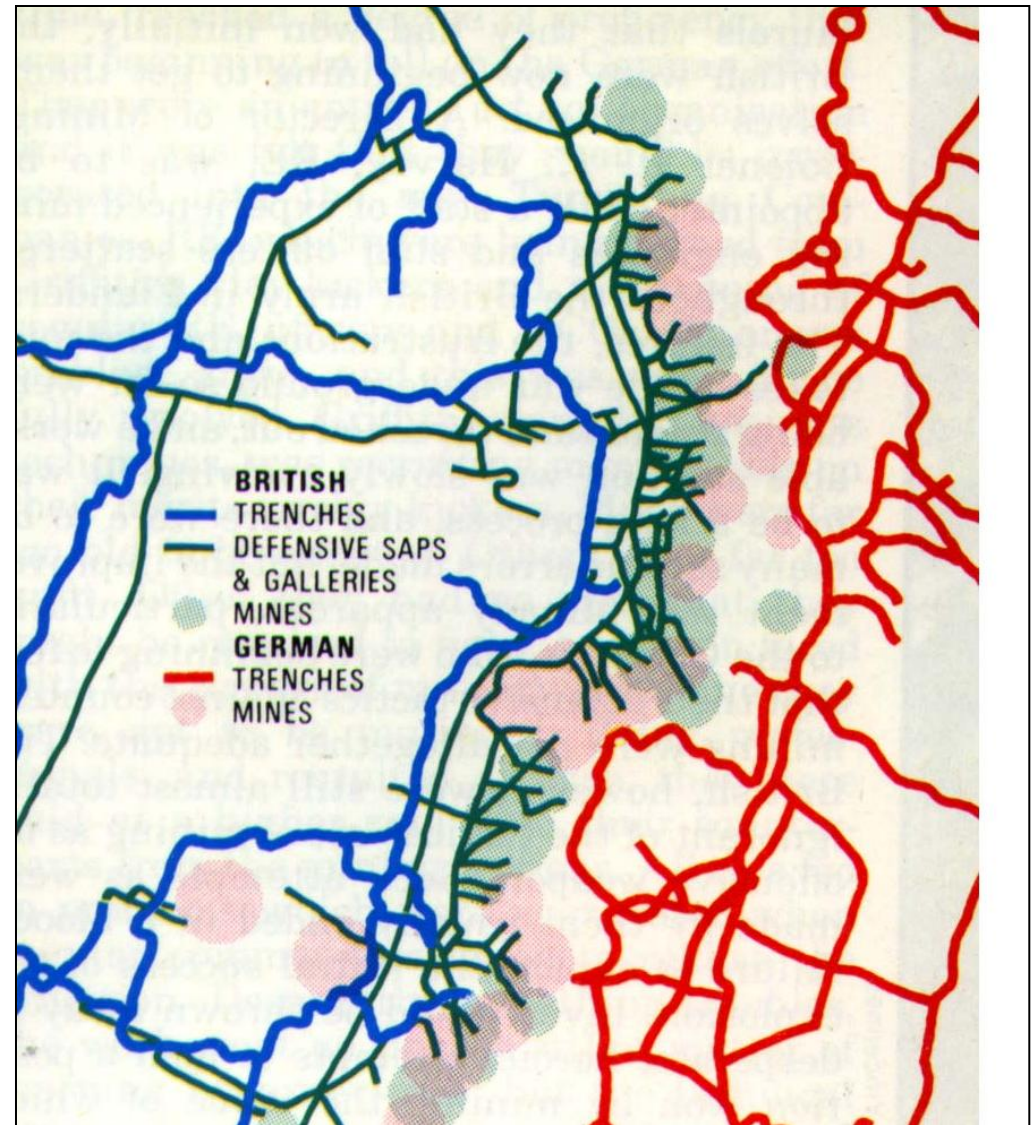

# HILL 60 MINES EXCAVATED BY ROYAL ENGINEERS

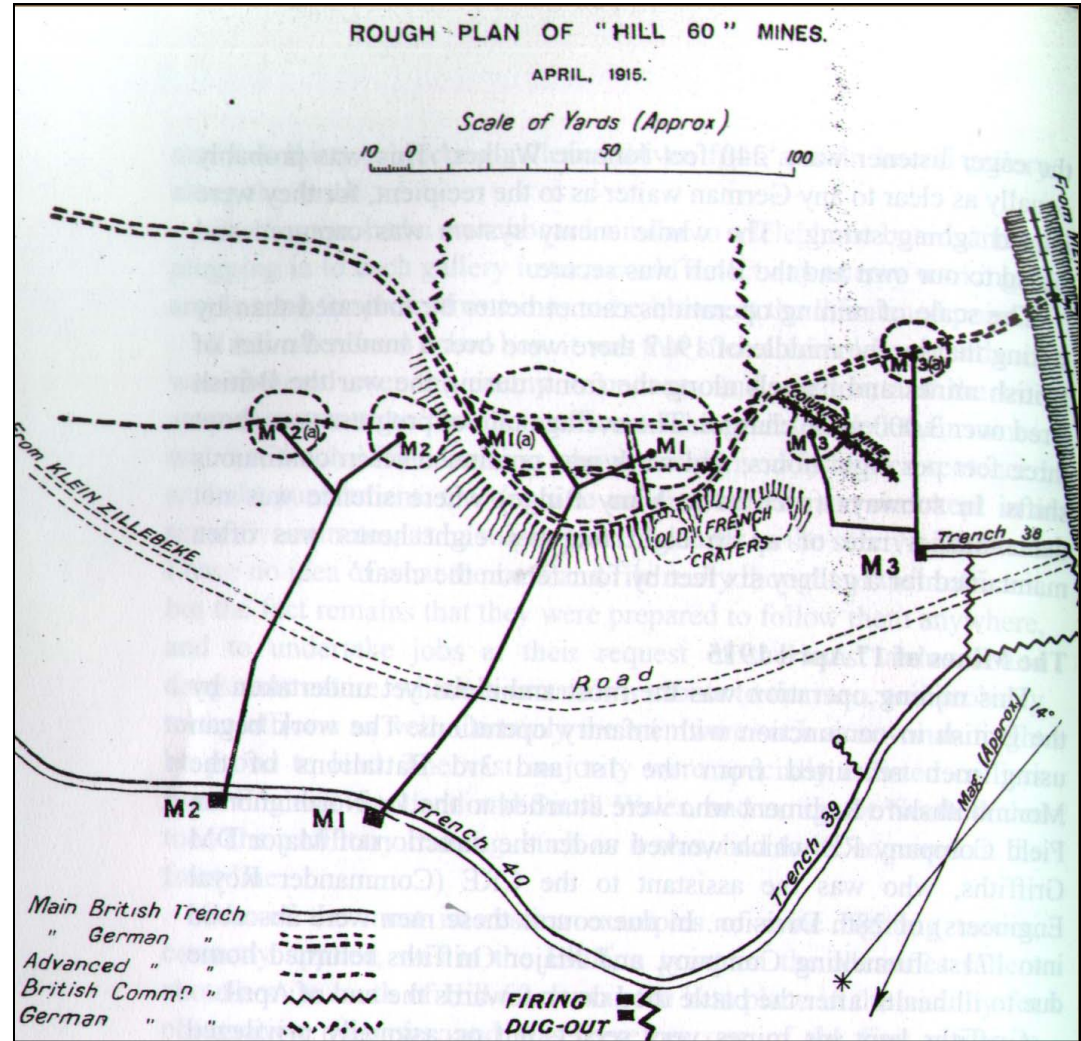

- Offensive Mining
- Example

# The Third Battle of Ypres: Messines Ridge (1917)

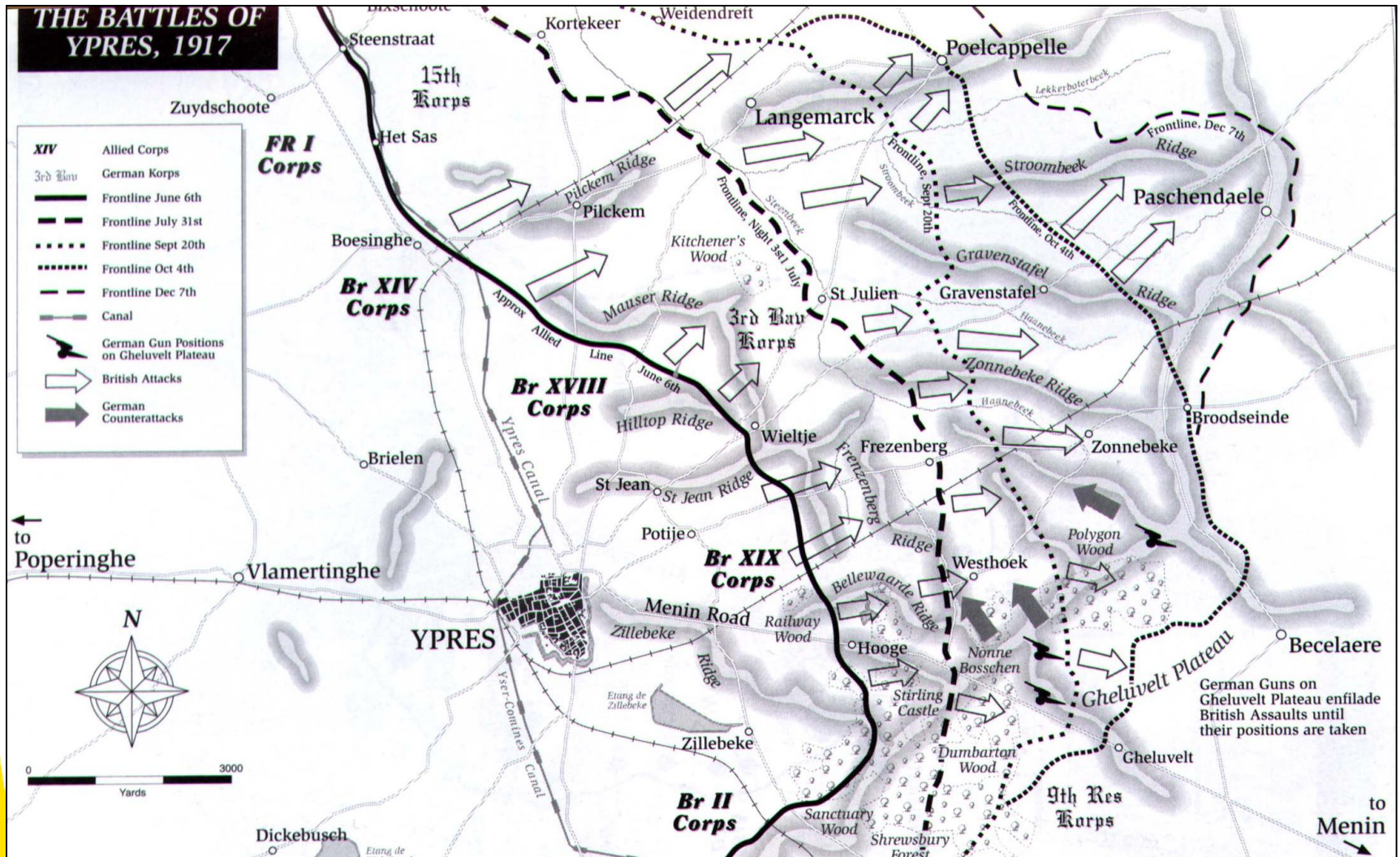





# MINE EXPLOSIVES LOADOUTS



- Craters
  - 21 Mines detonated
  - 200 – 2000 ft in Length
  - 50 – 125 ft in Depth
- Explosives
  - Over 1.2 million lbs detonated



CRATERS  
OF  
DEMOLITION BOMBS  
SCALE 1" = 234.56789 IN FEET

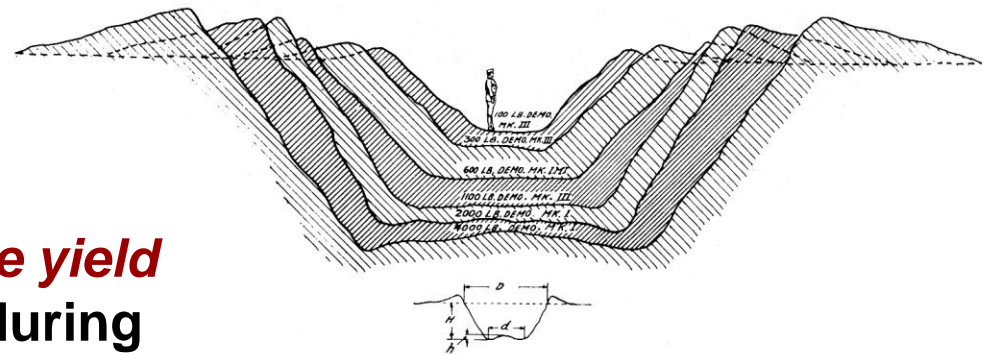

BOMB	D FT.	d FT.	H FT.	h FT.	CU. YDS. EARTH DISPLACED
100 DEMO. MK. III	21.8	6.0	6.8	0	42.3
300 DEMO. MK. III	27.0	9.3	8.4	0	86.8
600 DEMO. MK. III	38.1	15.2	11.5	0	251.5
1100 DEMO. MK. III	48.5	20.5	14.4	0	403.0
2000 DEMO. MK. I	45.2	24.5	16.5	12	600.0
4000 DEMO. MK. I	57.7	29.0	19.0	2.0	1078.0

Some very useful data on **explosive yield versus crater size** was developed during these operations, which proved valuable during the Second World War.

# ADVENT OF PROTECTIVE STRUCTURES 1939-45



**Aircraft achieved dominance during the Second World War, raining destruction on military and civilian targets well behind enemy lines**





400,000 civilians were killed in Great Britain during **The Blitz**. During the Summer of 1940 the government began evacuating children under the age of 12 to live with families in the countryside.

# Utilization of Transportation Infrastructure



- **Underground transportation facilities, such as railway subways, were used as bomb shelters**



**One of the first underground railway stations converted to bomb shelters during the night was Piccadilly Station, shown here**

# Down Street Station Underground Command Center



**Down Street UCC as it appeared during the war (at right) and today (above)**

# Home Security Region 5 War Room



**Command, communication and control facilities were moved underground after the fall of France in June 1940**

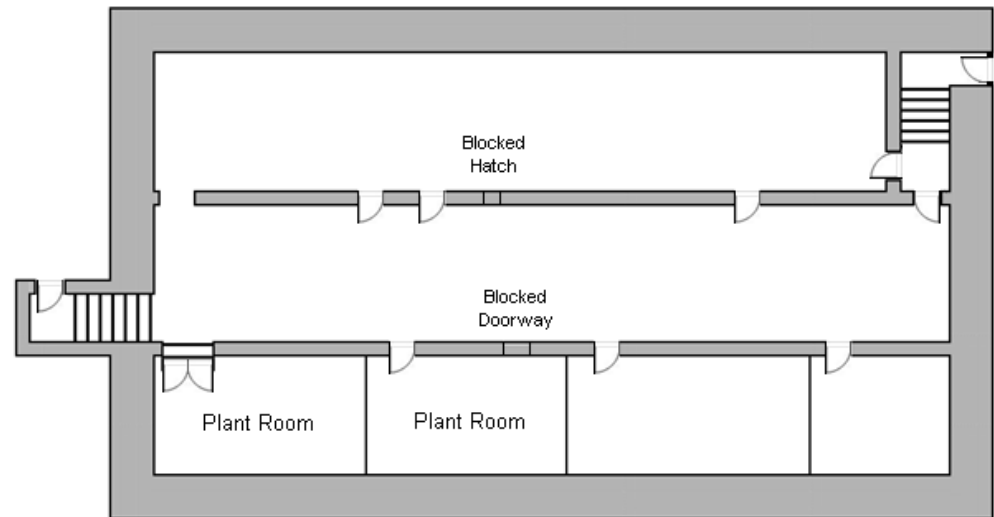

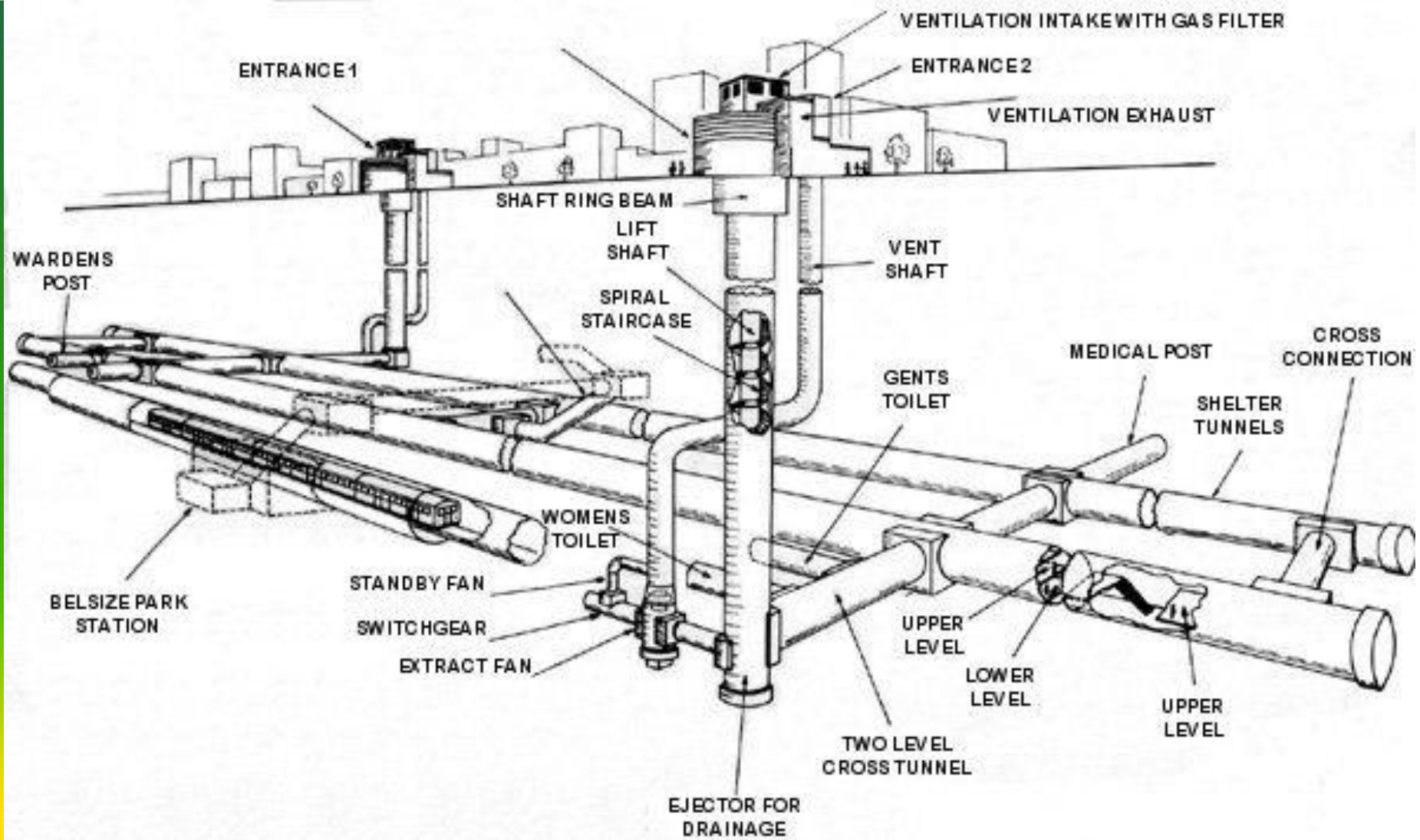

- The **second generation structures** were constructed solely as shelters. This shows the deep level shelters at Belsize Park, which were accessed by two circular turrets, which contained elevators and a spiral staircase leading down to the twin tunnels below.



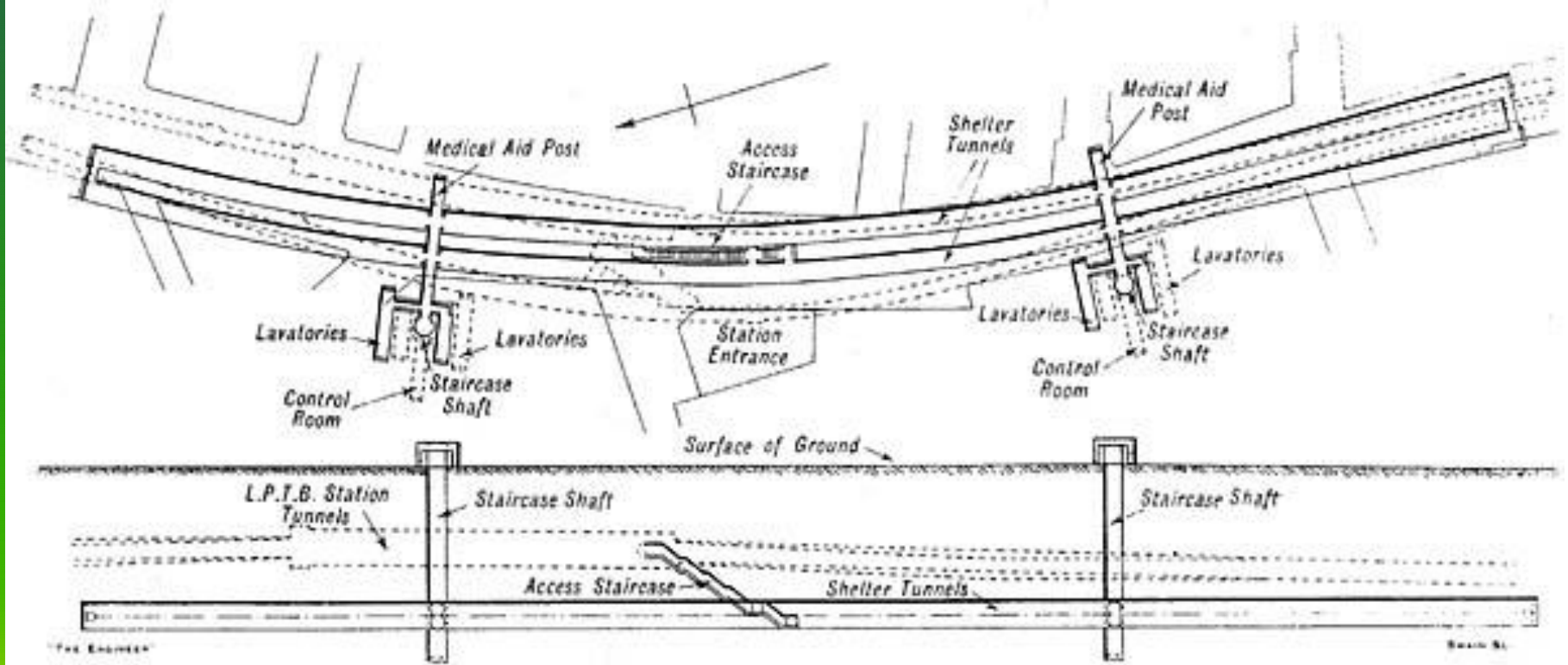

FIG. 1—ARRANGEMENT OF TYPICAL SHELTER

- Pairs of deep tunnel air raid shelters were constructed beneath existing underground railways in London after 1942. Each tunnel was intended to shelter 8,000 people!

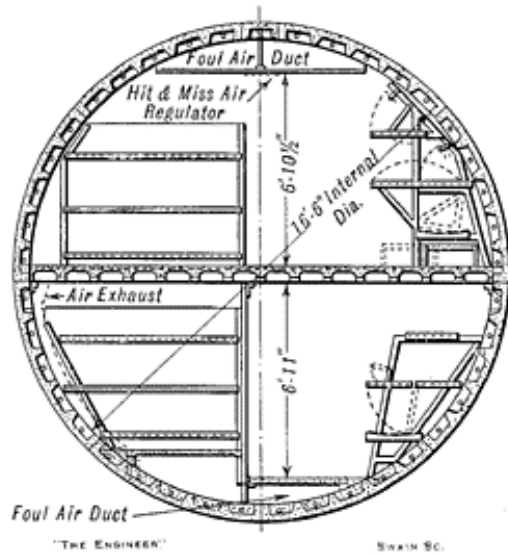

FIG. 6—SECTION OF SHELTER TUNNEL

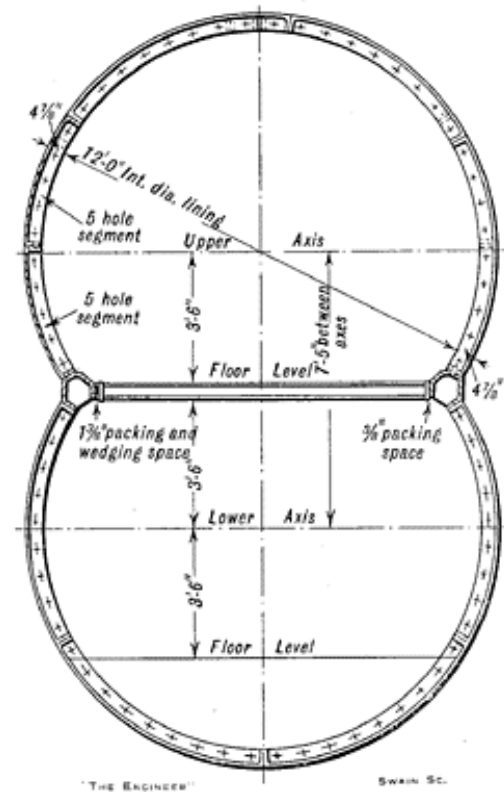
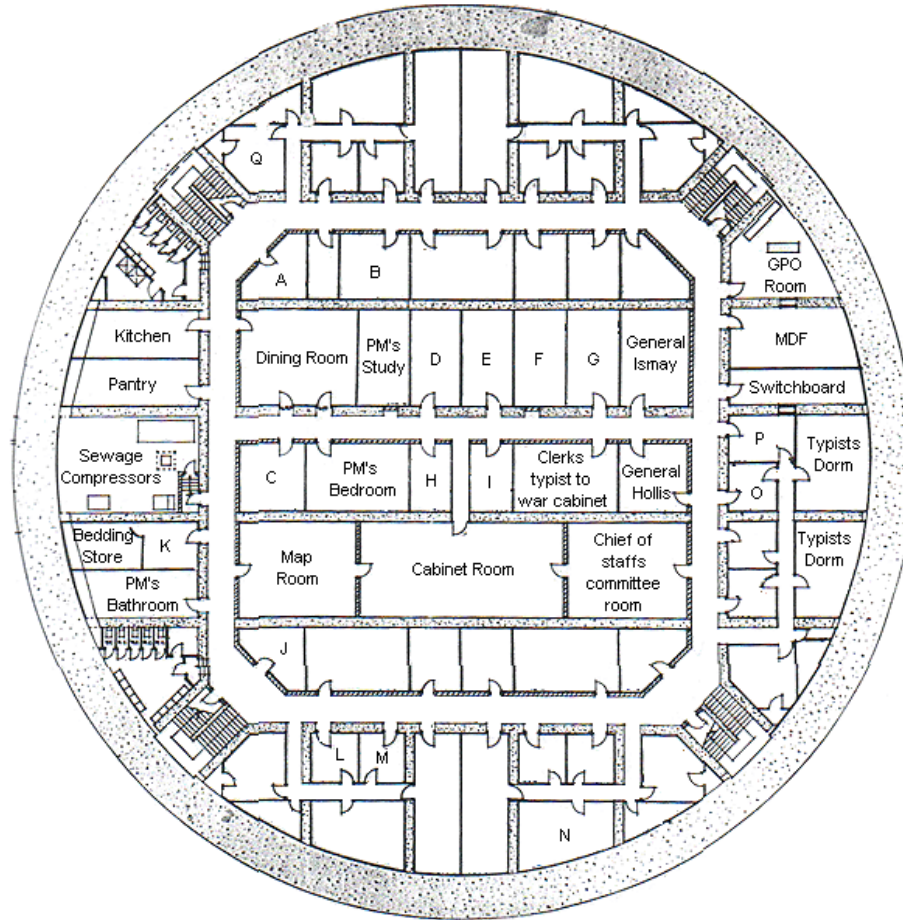

FIG. 7—SECTION AND DETAIL OF SUPERIMPOSED TUNNEL

- The deep tunnel shelter bores were 1400 feet long, using 16'-6" diameter bores. The government provided bunks, canteens to serve food, and a protected air supply. These were upgraded for use as **fallout shelters** during the Cold War

# The Rotundas in London



**The Rotundas** were enormous underground command and control structures, designed to protect essential government offices for extended periods of time

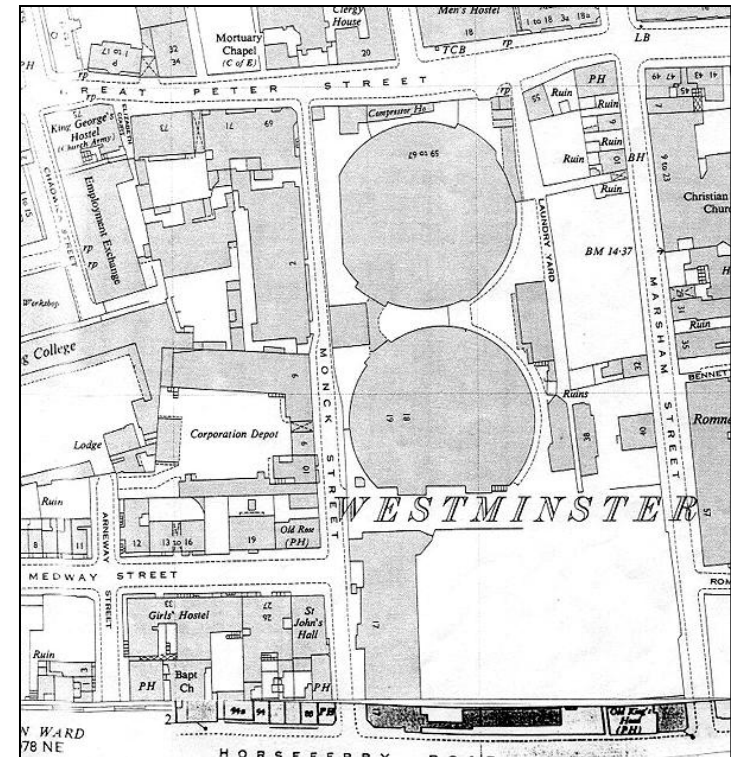



**By mid-1943 critical Allied facilities for command, communications, control, and intelligence (C<sub>3</sub> I) were moved to hardened underground structures across Great Britain.**

# Ridge Quarry

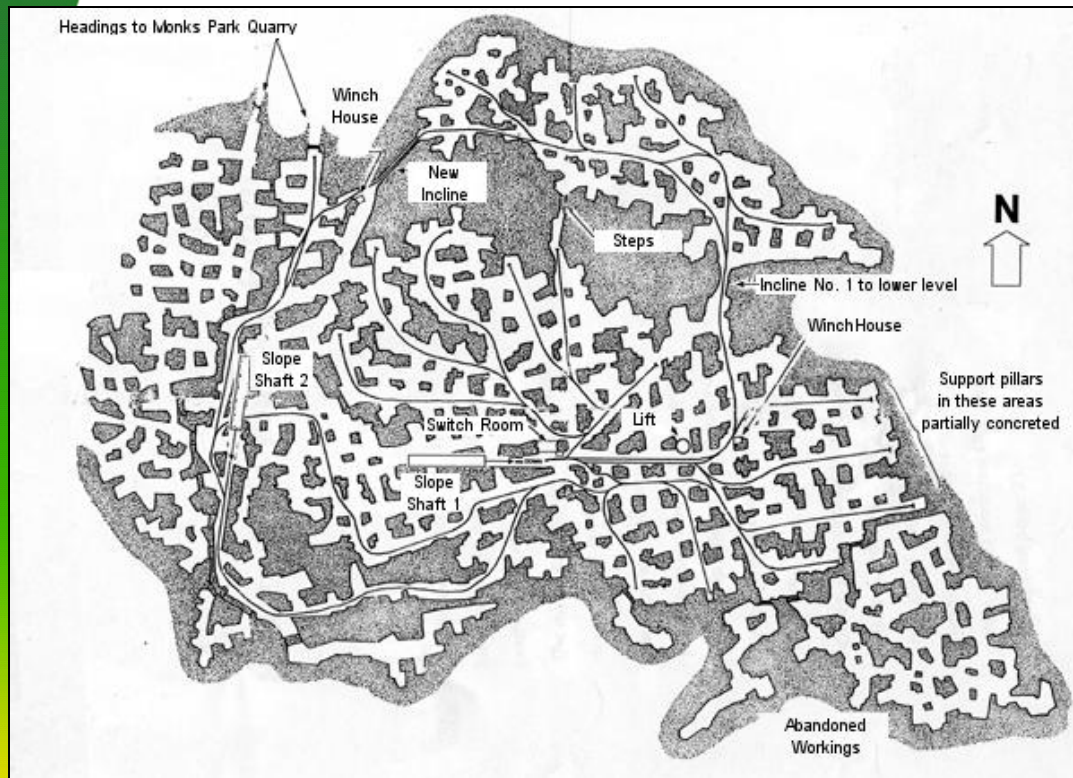

**Old underground mines in Great Britain were also utilized for storage of munitions and other critical war materials**

# Homeguard Underground Hideouts



After the fall of France in June 1940, **homeguard units** were established across England. These units constructed underground bunkers with escape tunnels. The bunkers were to provide shelter from artillery and aerial bombardment

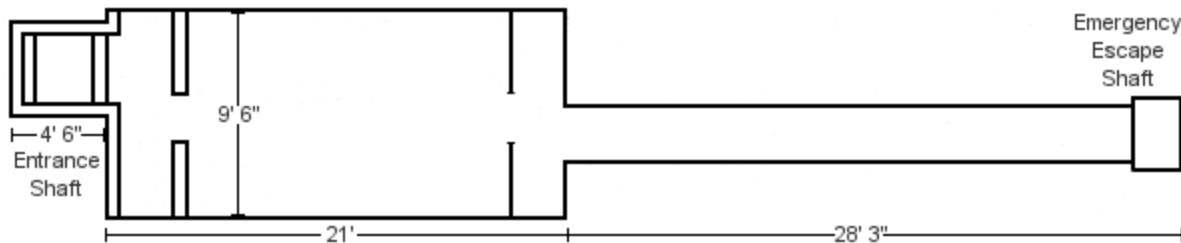

# Philippine Redoubt 1941-42

The island fortress of Corregidor held out for six months, between December 8, 1941 and May 6, 1942, exactly as planned



# Red Hill Fuel Storage Tanks Pearl Harbor

- Construction began Christmas 1940, and was completed in September 1943
- Project included 20 cylindrical tanks 100 feet diameter, 250 feet high
- Design capacity of 6 million barrels fuel oil

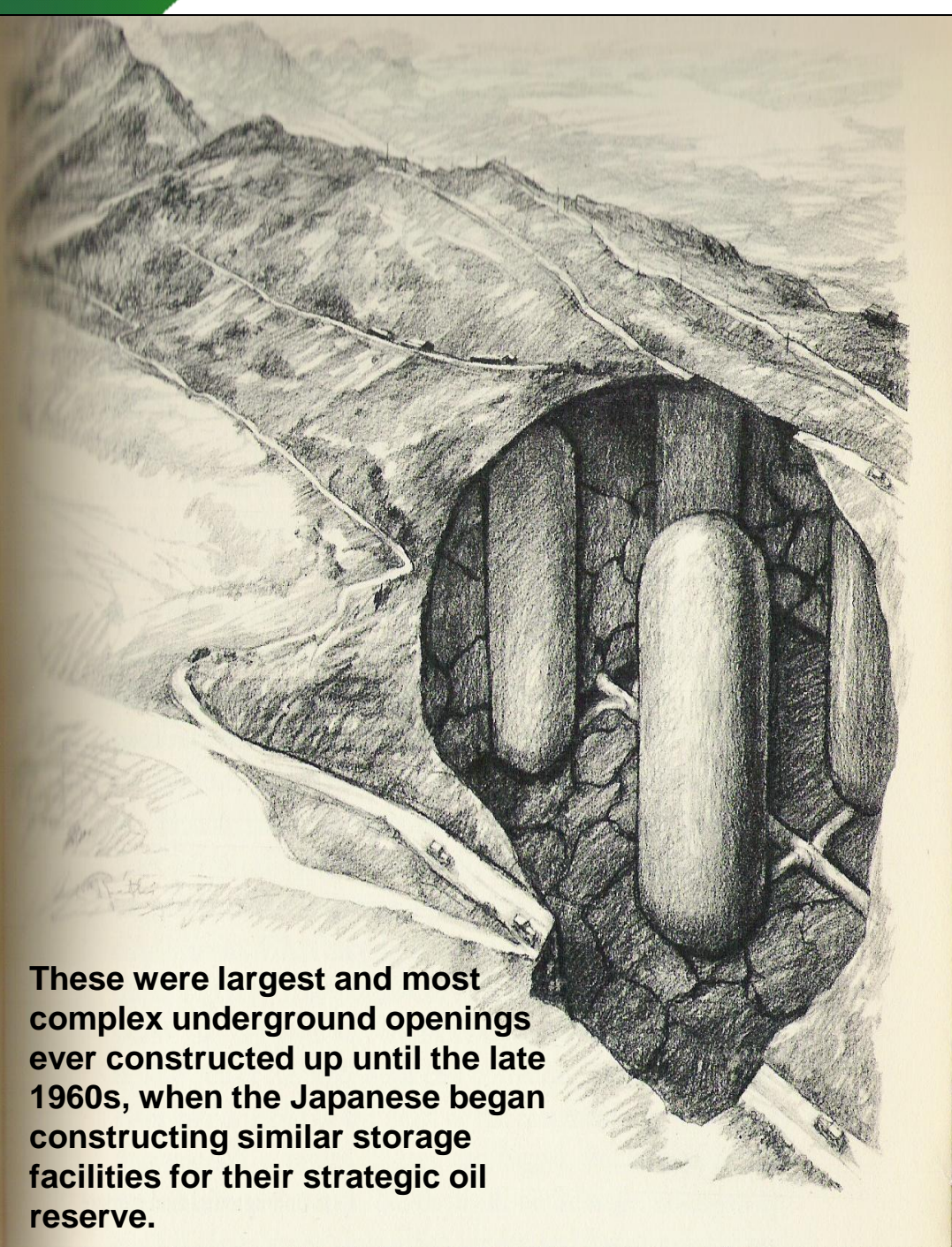

These were largest and most complex underground openings ever constructed up until the late 1960s, when the Japanese began constructing similar storage facilities for their strategic oil reserve.



# BOMBING OF GERMANY 1940-45

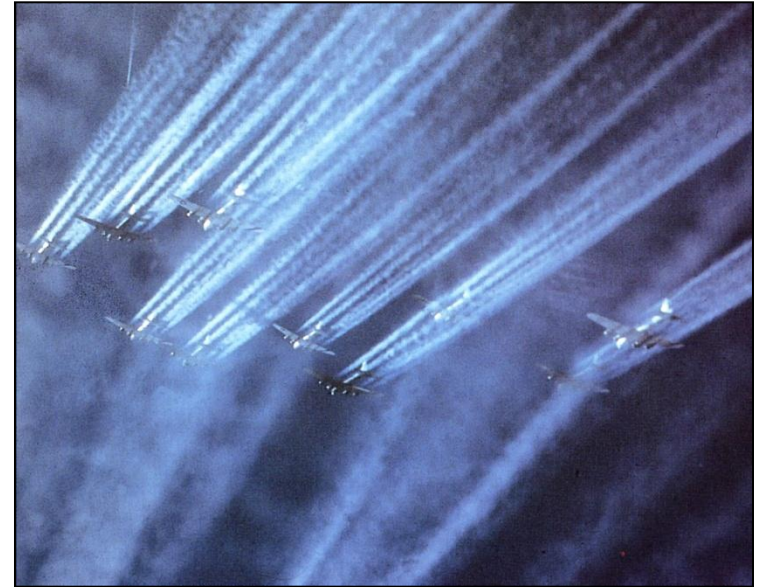

**During World War II 2,700,000 tons of bombs were dropped on Germany by Great Britain and the United States, raining destruction on German industry and their major cities**





- Many hardened objectives included extensive underground works, such as the catacombs at Monte Cassino Monastery in central Italy.



- It was bombed into oblivion by B-17s, B-25s, and B-26 bombers of the 15<sup>th</sup> Air Force after other attempts to neutralize it failed.
- It was not actually being used as an OP by German spotters
- The Germans were able to direct accurate artillery fire because Allied forces limited themselves to using the established road network, which the Germans had precisely mapped.

# ROUND-THE-CLOCK STRATEGIC BOMBING

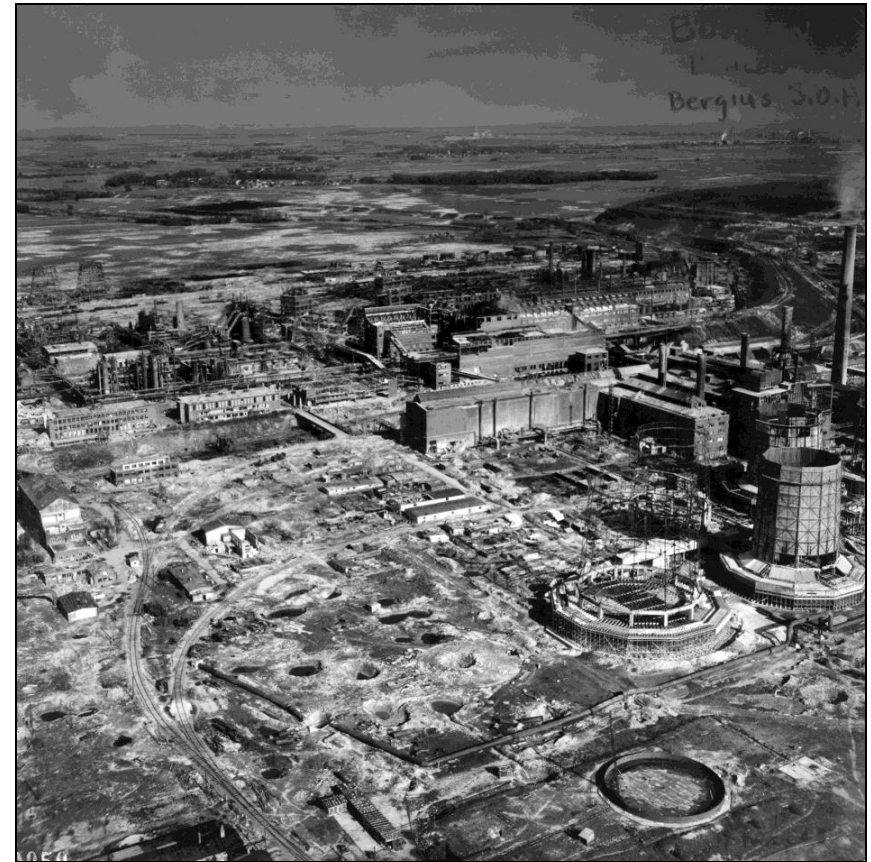

German war production plummeted as Allied bombing increased; persuading the Germans to *take their critical facilities underground*

# German Underground Openings



The German's first **underground POL storage facility** located the Schwalbe in the Hoenne Valley. This was part of the German's Mineraloelsicherungsplan, created by excavating tunnels from the Emil rock quarry.



Schwalbe

This underground facility was intended to store **240,000 gallons of diesel fuel** and **50,000 gallons of aviation gas**. The overall tunnel length was about 3 km. The tunnels were built by about 500 forced laborers and prisoners.

Lachs

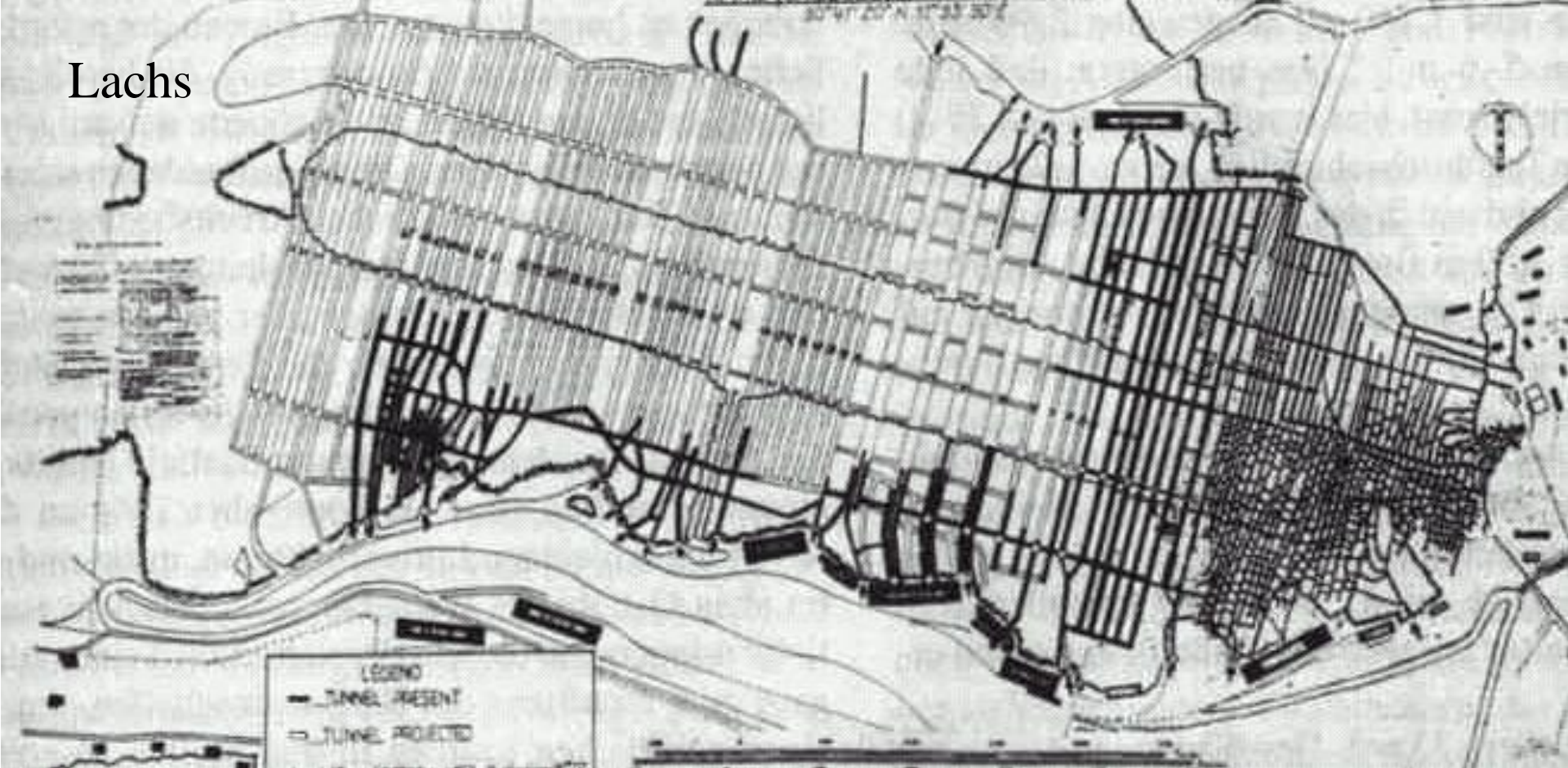

Me 262 factory in converted mine at Kahla/Grosseutersdorf, in Thuringen. Following an old mine, an extensive tunnel system was built. The **whole tunnel system should reach 30 km**. The underground working conditions were very bad; there was **not sufficient fresh air**. Seven months after beginning the fresh air problem was not solved. Most of the work was carried out by 12,000 slave workers; of which 991 deaths were recorded due to malnutrition and accidents.

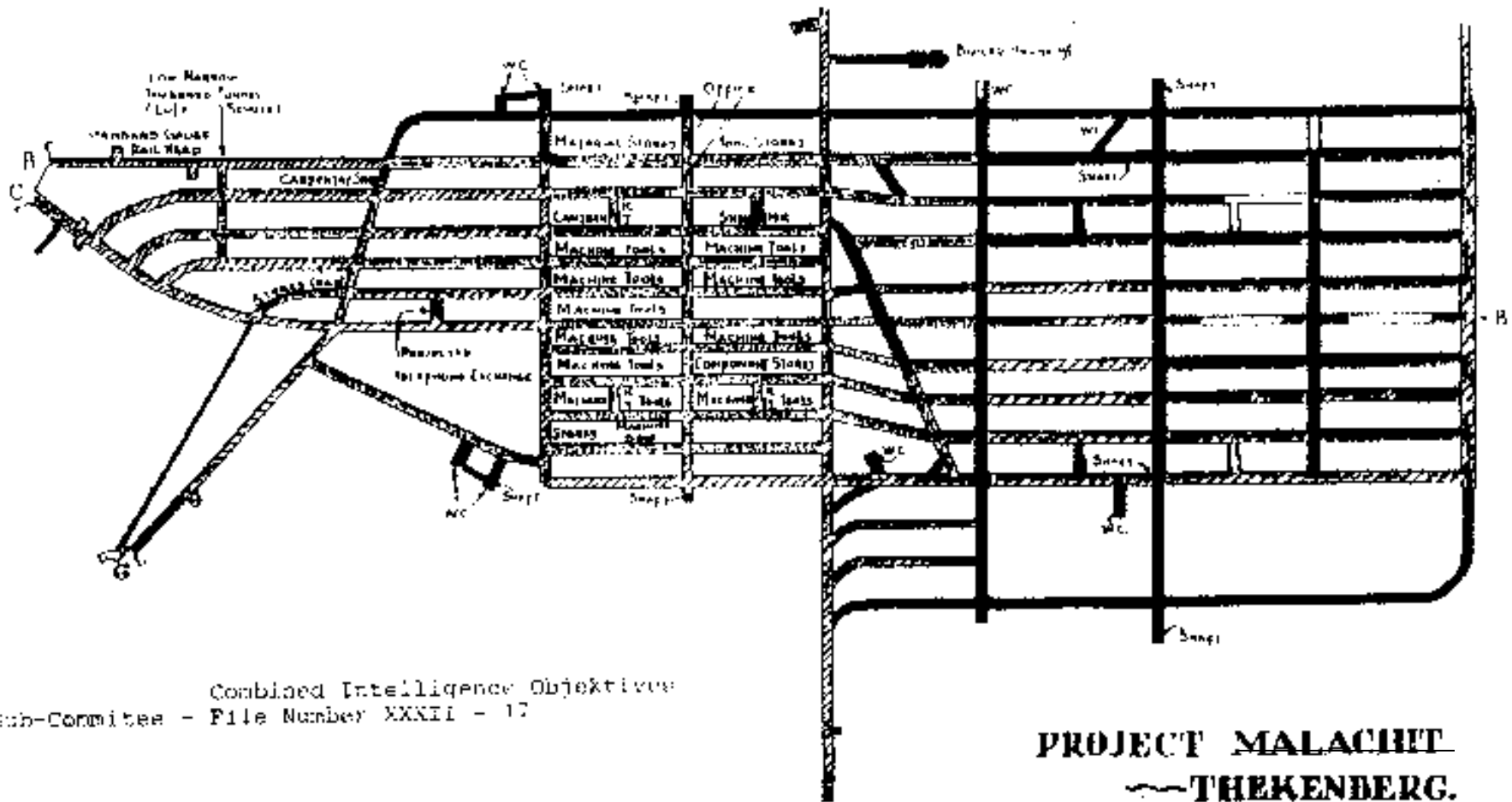

Combined Intelligence Objectives  
 Sub-Committee - File Number XXXII - 17

**PROJECT MALACHIT  
 THEKENBERG.**

**Junkers aircraft factory near Langenstein and Halberstadt. By the end of the war the Germans had lost 4,819 workers through “tunneling accidents” and another 853 died while building aircraft, because of the poor ventilation.**



**The Germans gradually stashed all of their critical materials underground, including the Deutschebank silver and gold reserves, shown at left. The photo at right shows Generals Eisenhower, Bradley, and Patton inspecting stolen art treasures that had been hidden in an old salt mine, discovered by Patton's combat engineers.**





Spitfire fighter chasing a V-1 positioning itself to tip the drone over with its wingtip

# BUZZ BOMBS AND VENGEANCE WEAPONS

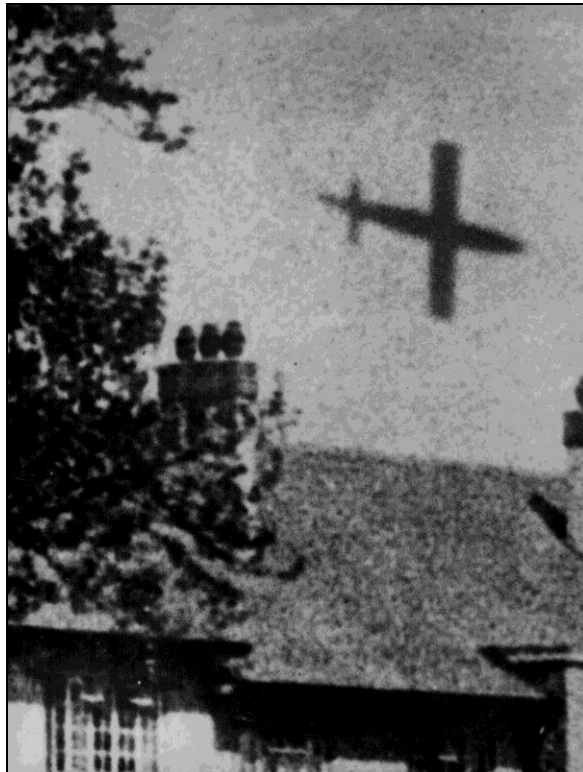

The V-1 fell on a parabolic trajectory after its engine shut down



The V-2 moved at supersonic speed, between 1,790 and 3,580 mph

- The Germans launched 9,521 V-1 buzz bombs and 3,000+ V-2 rockets at Allied military and civilian targets in western Europe and England.
- American proximity AA rounds saved the day by downing about 79% of the V-1s launched by late 1944.
- The V-2s could not be challenged because of their speed and altitude.

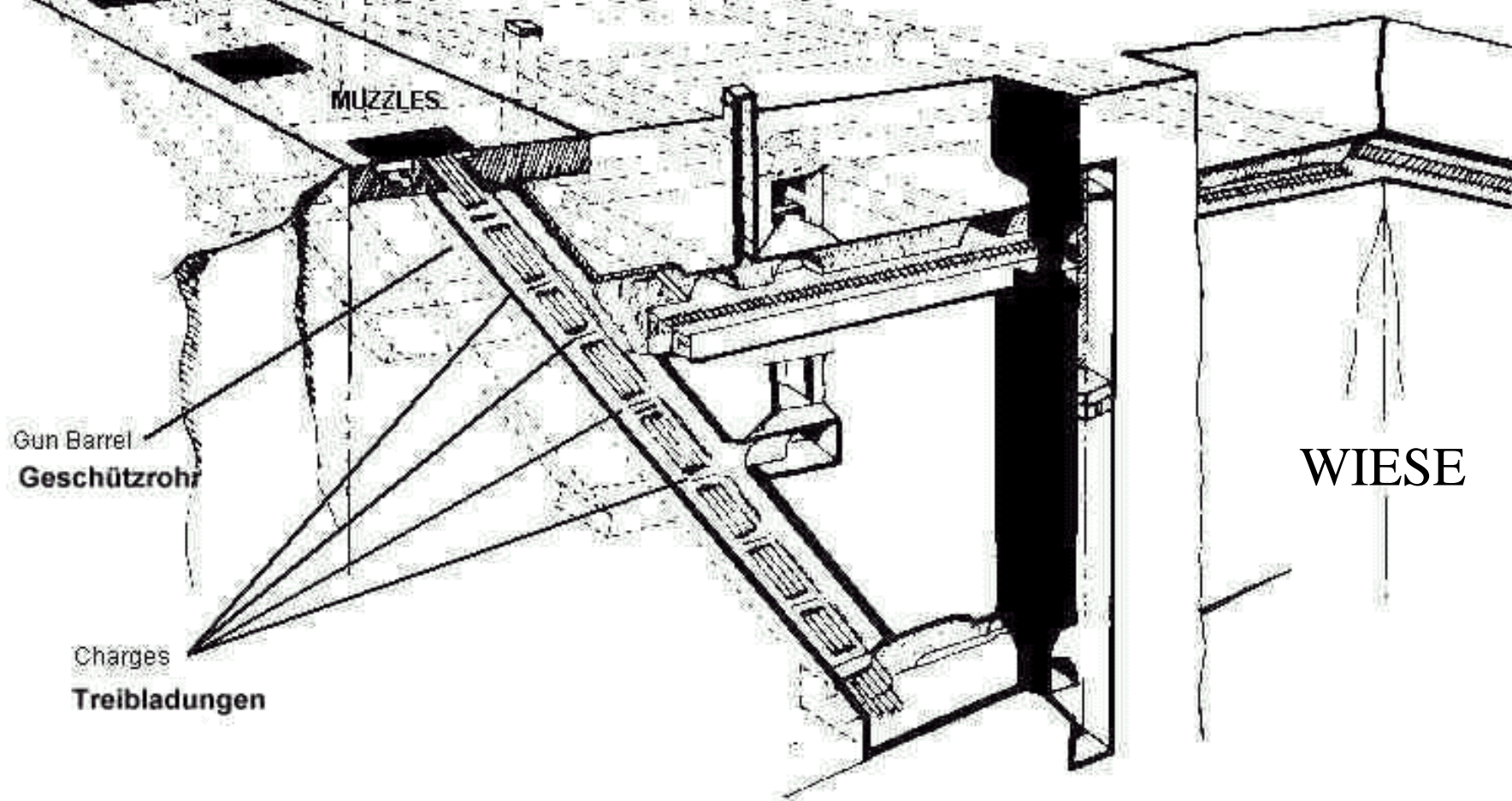

**The V3 had a barrel length of about 124 meters!** The weight of this weapon was 76,000 kg. Every time, the grenade passed one of 32 intermediaries, a new charge of explosives, stored in the sides, was ignited, so that the grenade gained more and more thrust to an planned velocity of 1500m/sec., with a range of ~160 km. Actual velocities reached about 1400m/sec. The underground fort was excavated to a depth of more than 100 m and employed a gun crew of about 1100 soldiers. The fort was projected for 25 guns. In July 1944 an allied air attack destroyed the fort's entrances using 11,000 lb Tallboy bombs.

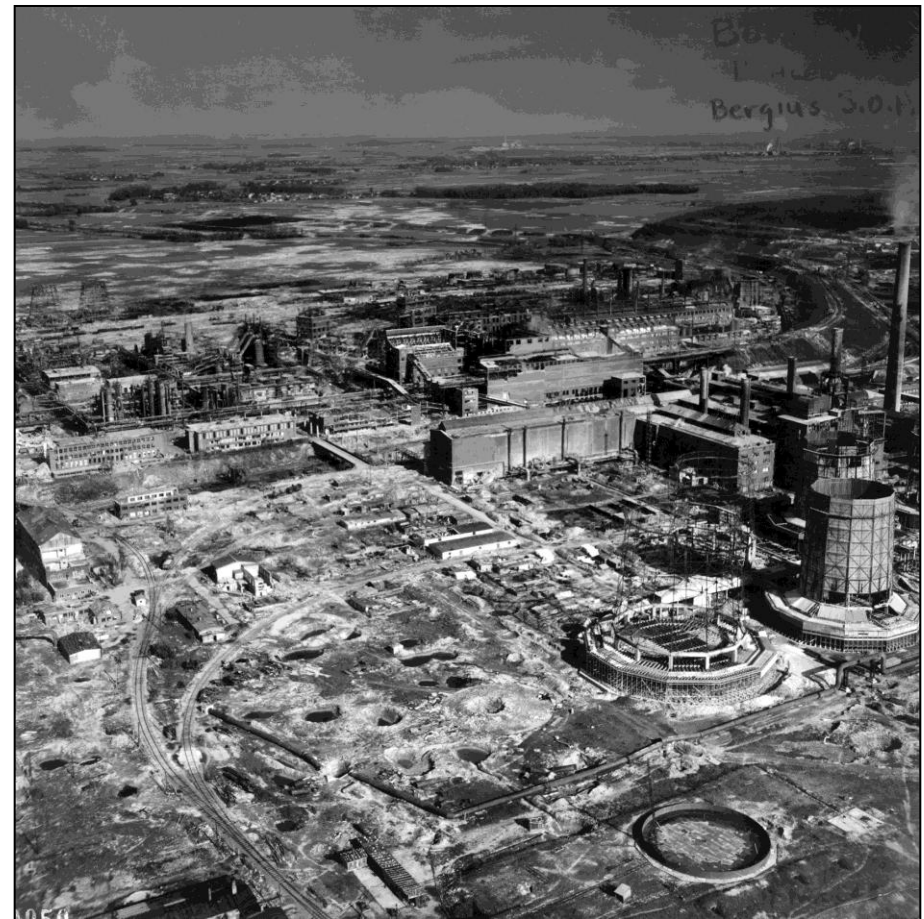
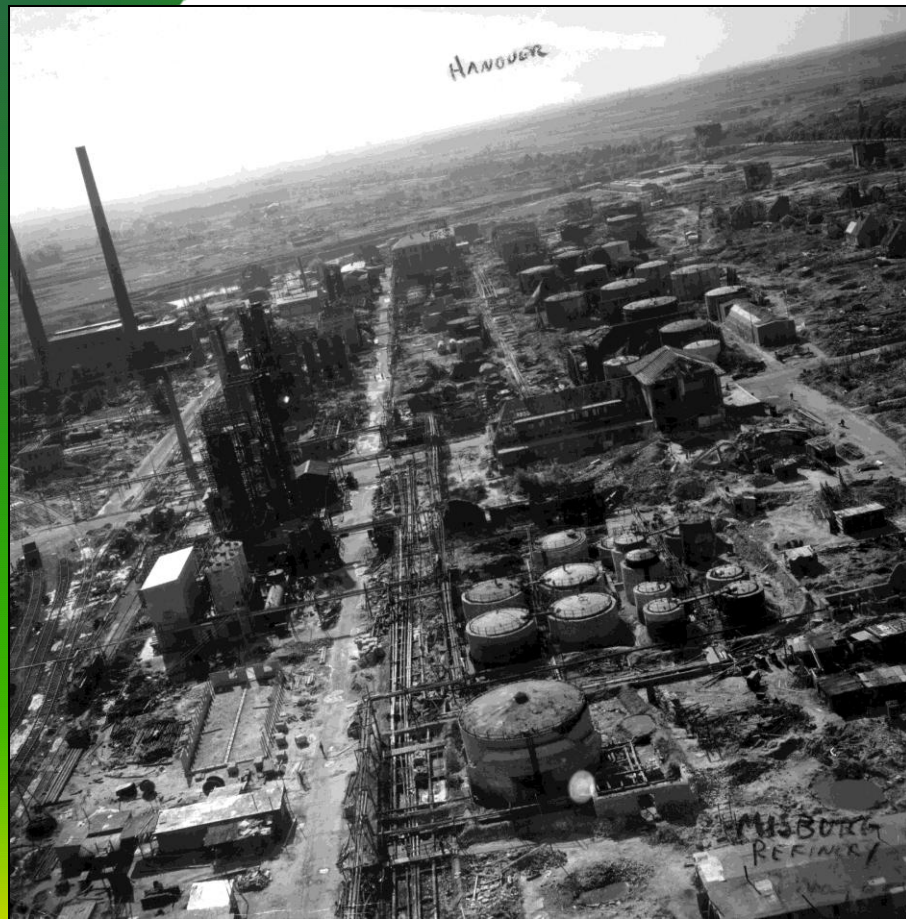

**Every plan has its *Achilles Heel*.** The Germans were unable to relocate their electric power plants and oil refineries underground because of ventilation and space requirements (e.g. for cracking towers). This limitation hastened their rapid downfall during the last year of the Second World War.

# PETROLEUM, OIL, AND LUBRICANTS



**From April to September 1944, 96% of Germany's petroleum, oil and lubricants manufacturing capacity was destroyed by American strategic bombing**

# BURIED UTILITIES ABOUND in BIG CITIES



# WARSAW GHETTO REVOLT of 1943



**During the Warsaw Ghetto Revolt of April-May 1943 Jewish fighters survived fire bombings, gassing, and flame throwers by hiding in the underground sewers of Warsaw.**



# LARGE DIAMETER SEWERS



There are 6,000 miles of sewers in New York City. About 75% of these are combined lines, carrying **stormwater runoff** as well as **sewage**, and would be large enough for a person to pass through.

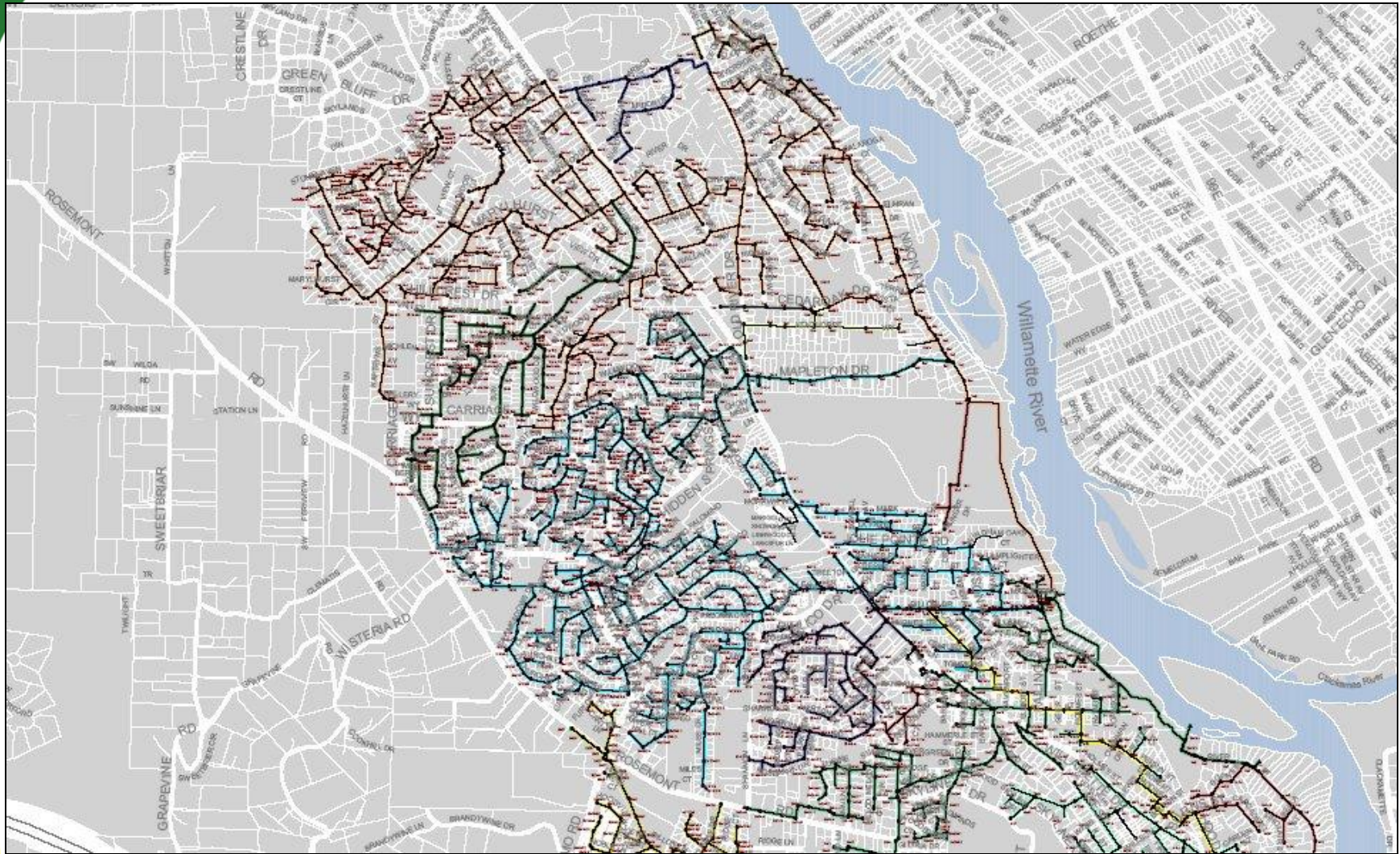

- **Most sanitary sewer systems in the USA are inventoried on existing GIS**



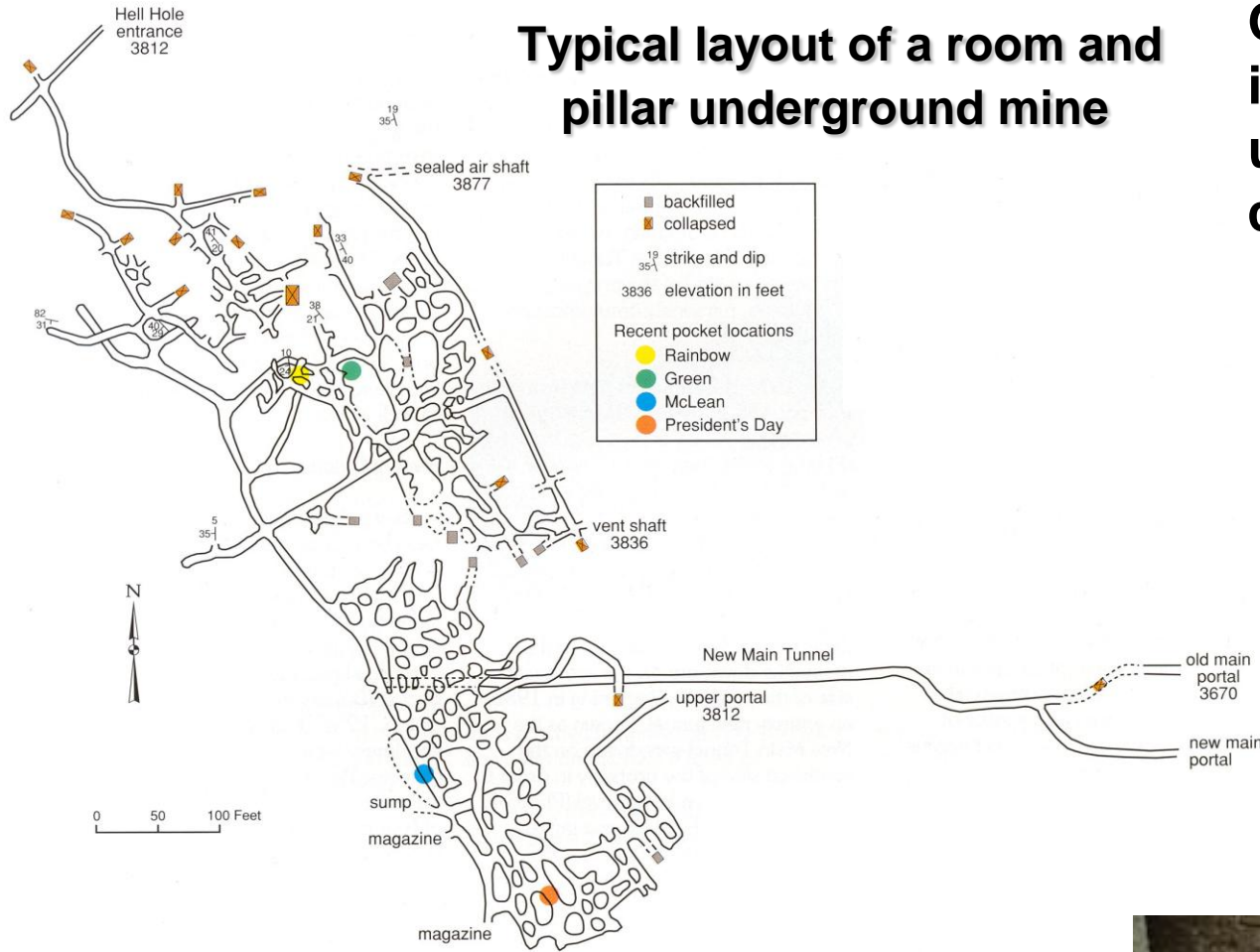

## Typical layout of a room and pillar underground mine

Old limestone quarries increasingly utilized for underground climate-controlled storage

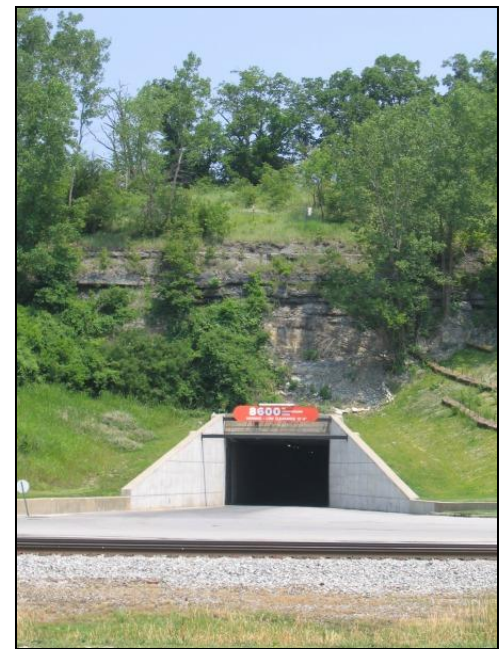

In the 1980s inactive underground mines began to be utilized for commercial storage and energy efficient office space



# COLD WAR ERA 1949-1991



**Fears of atomic war typified the Cold War era following World War II, between 1949-91**



- **Construction of a protective bunker for the U.S. Congress began in early 1959 and took 2 1/2 years to complete, at an estimated cost of \$86 million. The 112,544-square-foot bunker lies 64 feet beneath the West Virginia wing of **The Greenbrier Resort** in White Sulphur Springs, West Virginia.**
- **At the time, the cover story for the shelter was that The Greenbrier was constructing a medical clinic. Word first leaked about its existence in the Washington Post magazine in 1992. The resort is now a national historic landmark.**

# GREENBRIER CONGRESSIONAL BUNKER

## View the Bunker

You can access a QuicktimeVR of any of the rooms highlighted in the floorplan to the right.

Please see the text below for the technical requirements to view the bunker.

1. POWER PLANT
2. DINING ROOM
3. THE WEST TUNNEL
4. RECORDS STORAGE
5. TV CONFERENCE/BRIEFING ROOM
6. DORMITORY
7. MEDICAL FACILITY
8. SENATE LEADERSHIP ROOM

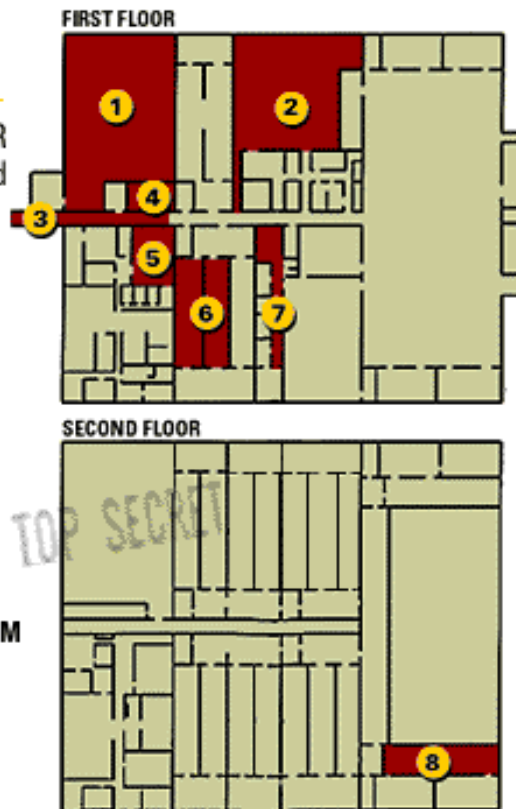

Emergency broadcasting studios



## SECURITY

The 25-ton blast doors were intended to protect the shelter's residents.



## ER

The shelter had a 12-bed hospital...



## WELCOME

The entrance to the shelter is lined with decontamination showers.

The two-story bunker was designed to house the entire United States Congress and support staff for forty days in the event of a nuclear attack on this country.

# KOREAN INFILTRATION TUNNELS

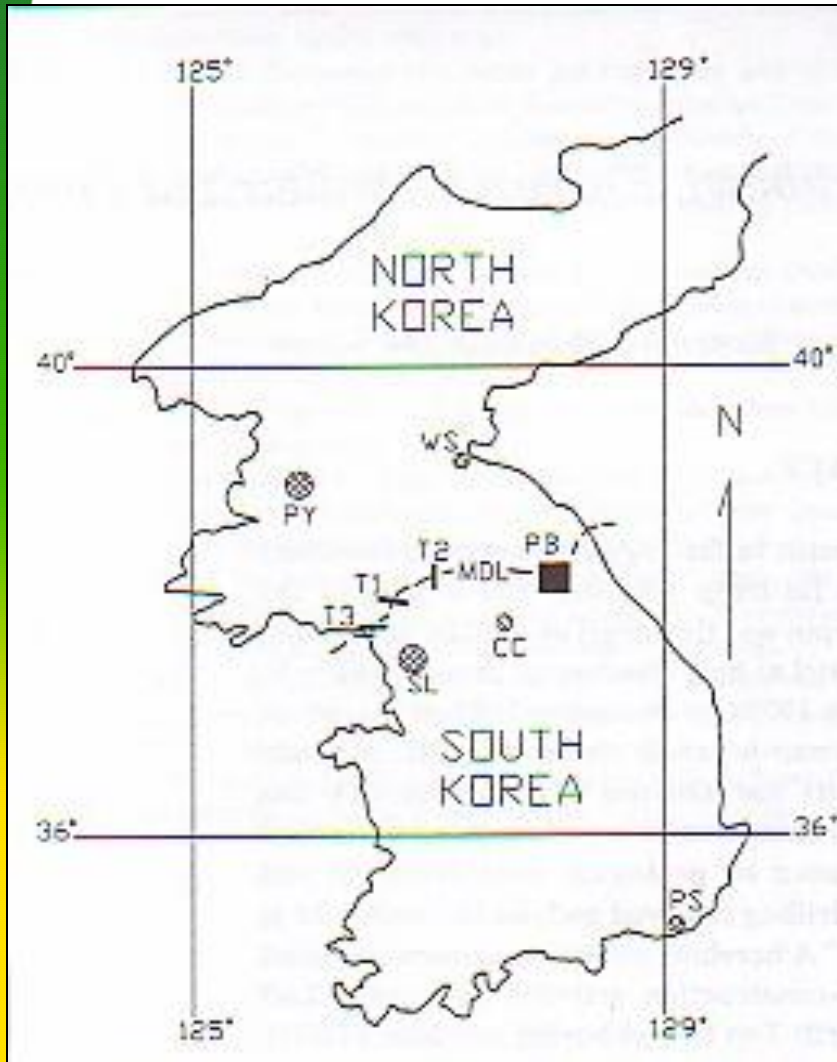

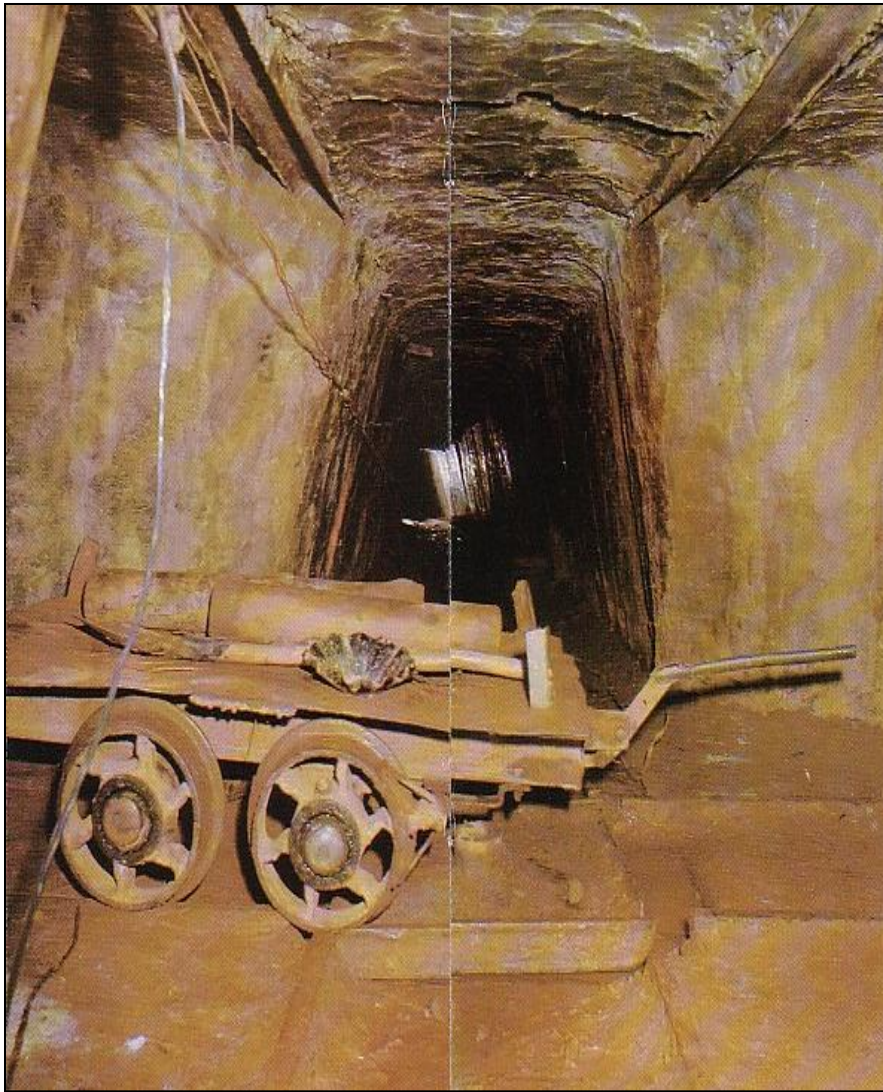

**Tunnel #1**



**Tunnel #2**

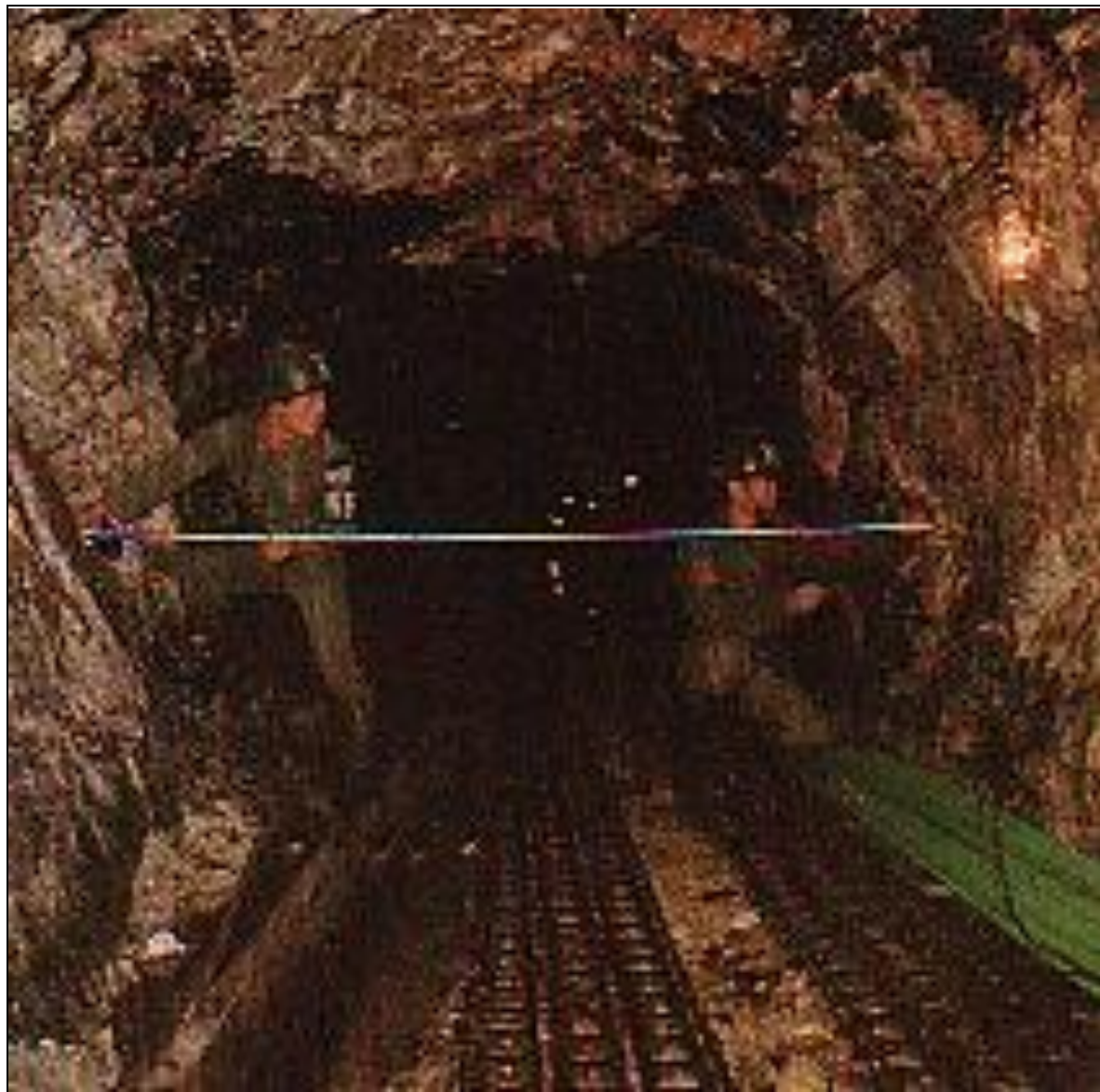

**Tunnel #3: Notice the rails for muck cars and water lines emplaced by the North Koreans**

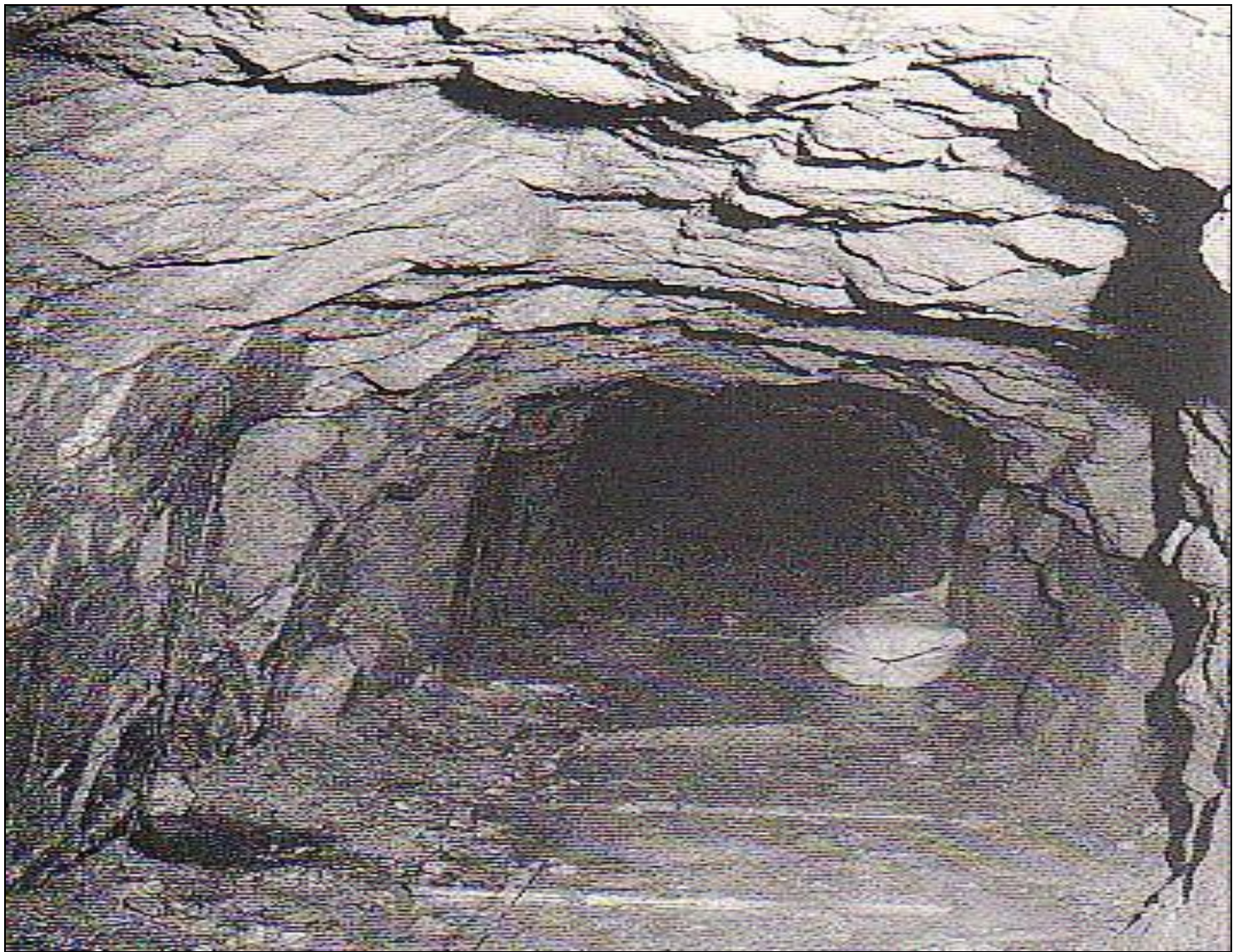

**View inside Tunnel #4**



# Detection Methods and Techniques

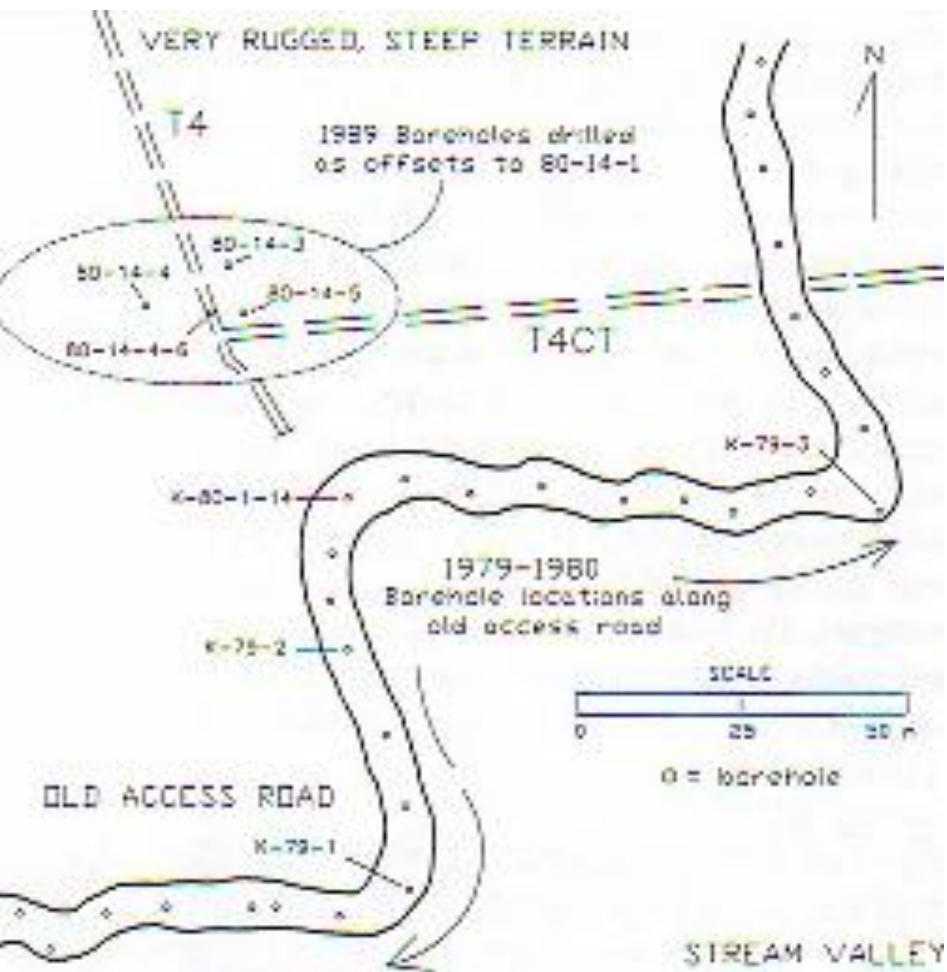

**Boreholes used in exploration for Tunnel #4 and the intercept adit constructed by allied forces**

**ROK truck Mounted drill rig used on the old access road**



**U.S. mobile (skid) drill rig used in the rugged steep terrain**

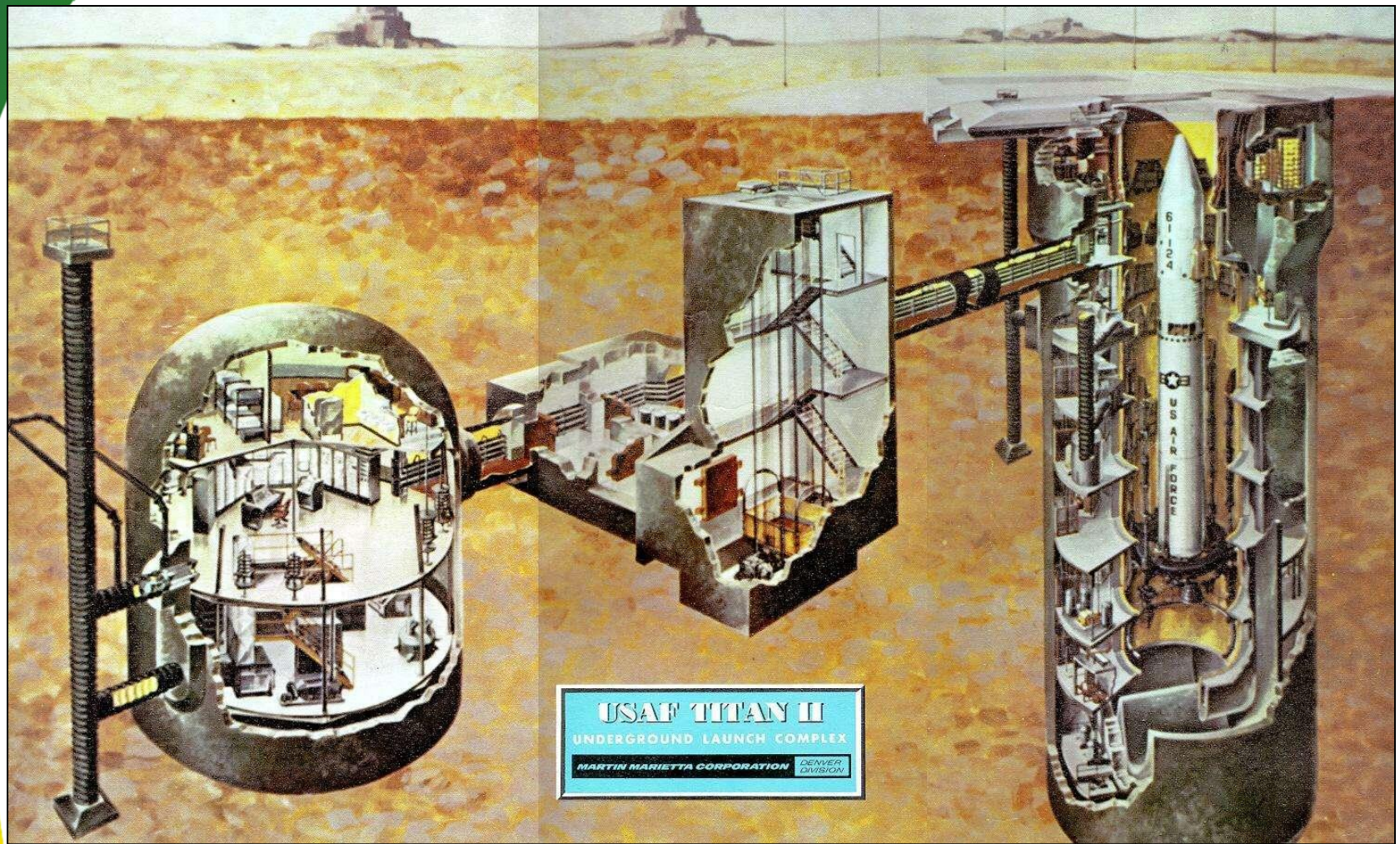

**Control Center**

**Access Portal &  
Blast Lock Area**

**Silo**

**Cutaway view of a typical underground Titan II missile complex**



**Close up of Launch Control Capsule under construction at  
Ellsworth AFB, SD in Sept.1962**



**Construction of Minuteman Launch Silo B-11 at Whiteman AFB, MO on June 18, 1962**

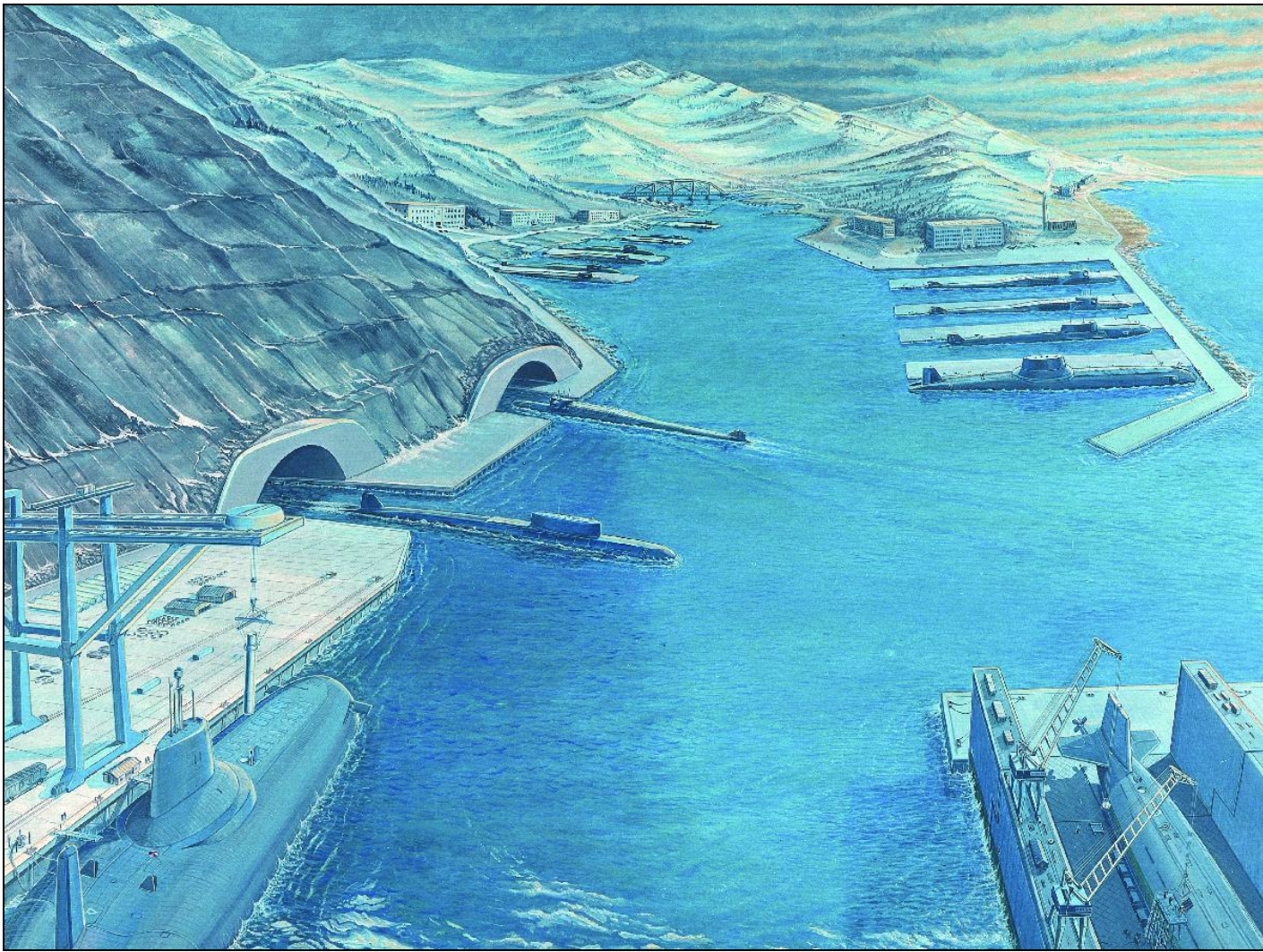

- **During the Cold War the Soviets constructed dozens of tunnels at their submarine bases to shield them from nuclear attack. Several of these now serve as tourist attractions.**

# THE VIETCONG TUNNELS OF CHU CHI WERE CONCENTRATED IN THE IRON TRIANGLE AREA, WEST OF SAIGON

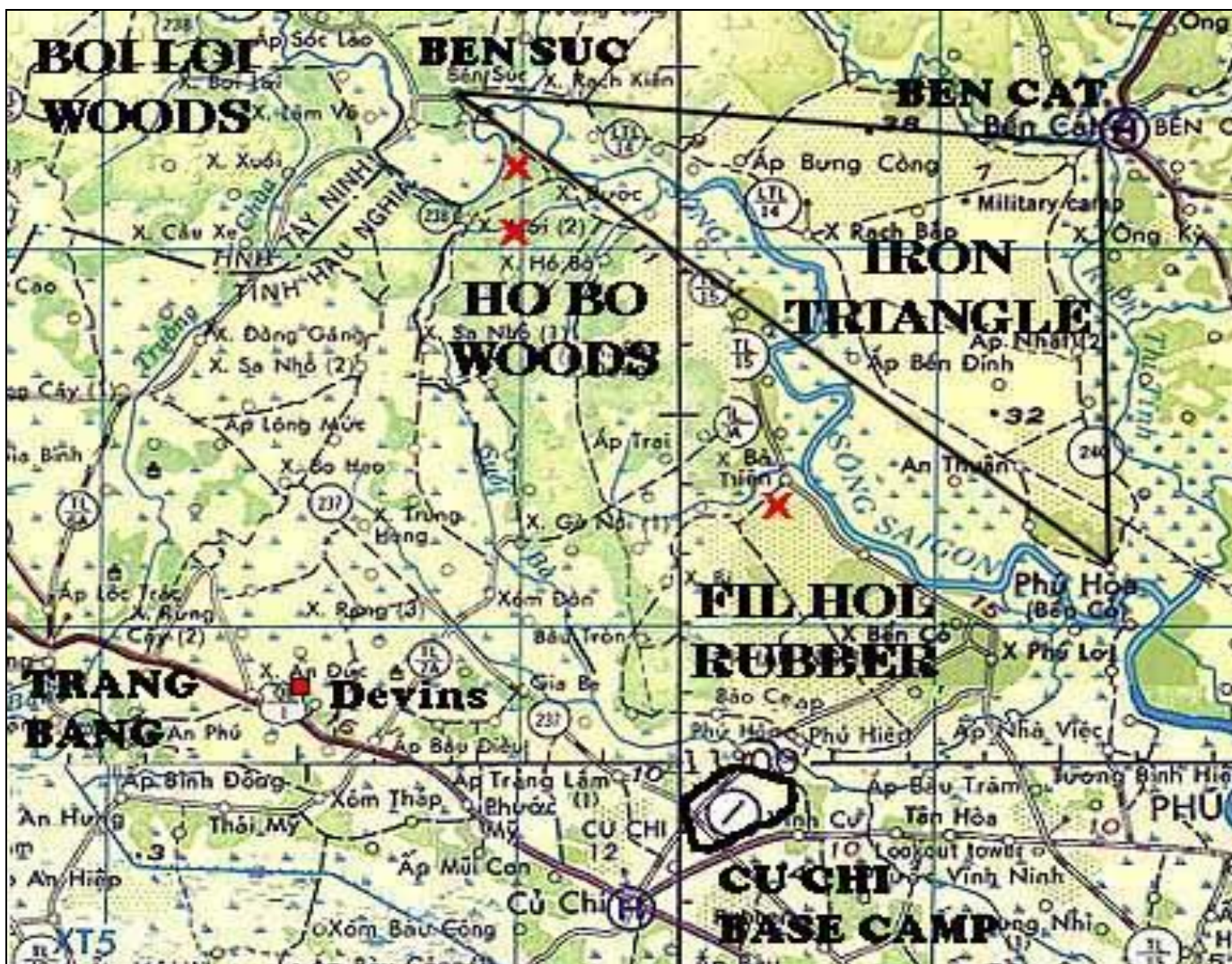

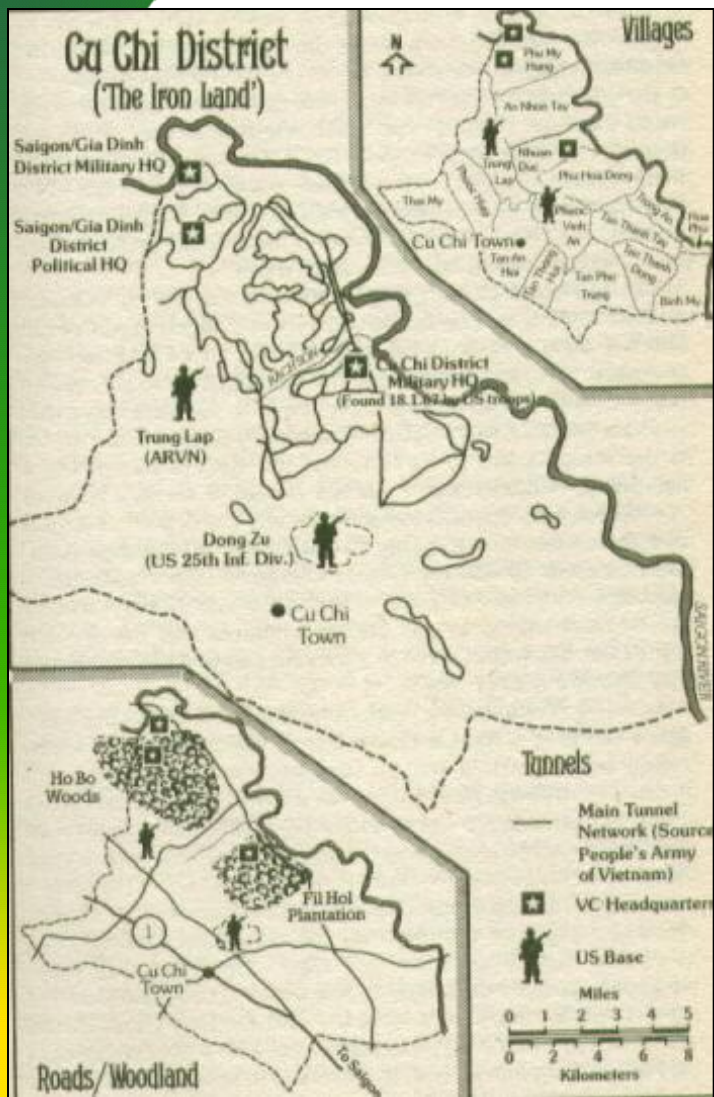

The **Chu Chi tunnels** were a serpentine labyrinth of interconnected openings with multiple levels, separated by water and air tight trap doors.

## NVA/VC Tunnel Complex Basics



Entrance



Inside



The tunnels were excavated in ***cemented laterite clay*** above the water table, which was at -9 m





**Today some of the tunnels are set aside as a war memorial/tourist attraction, intended to commemorate their success. Here the soil cover has been excavated to reveal their internal layout and structure.**

# GEOFORENSICS AND THE WAR ON TERROR



- **Geoforensics is the use of geoscience principles to solve various mysteries involving earth and ocean systems. This includes applications to engineering failures as well as crimes involving our criminal justice system.**
- **The background in this photo of the late Osama bin Laden appears to be a type of karst feature called "rillenkarren," in the Tora Bora Mountains. Rillenkaren is not altogether rare, but not that common either.**

# KARST FEATURES AND CAVERNS



- **Approximately 22% of the United States is underlain by karst**

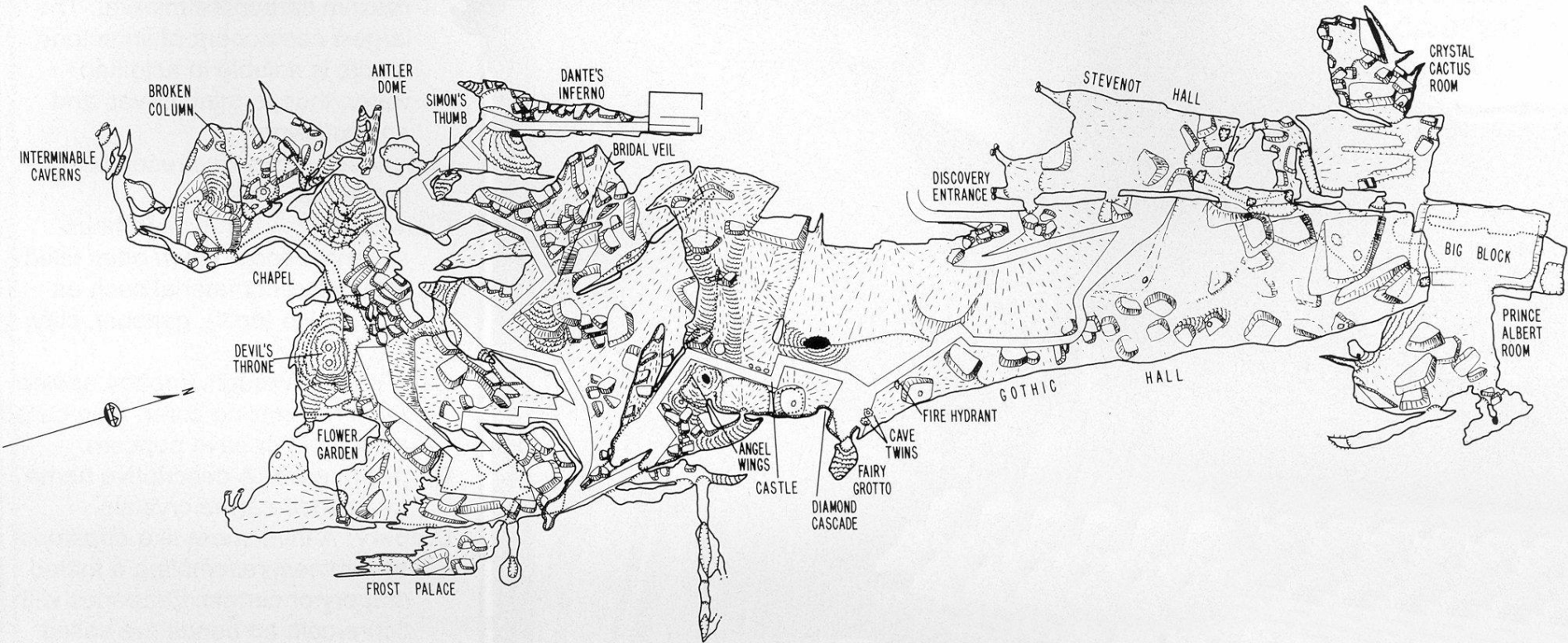

- **Three-dimensionally complex:** Plan view of **Mercer Caverns** in California prepared using methods recommended by the Cave Research Foundation: using a Suunto compass, inclinometer and fiberglass tape.

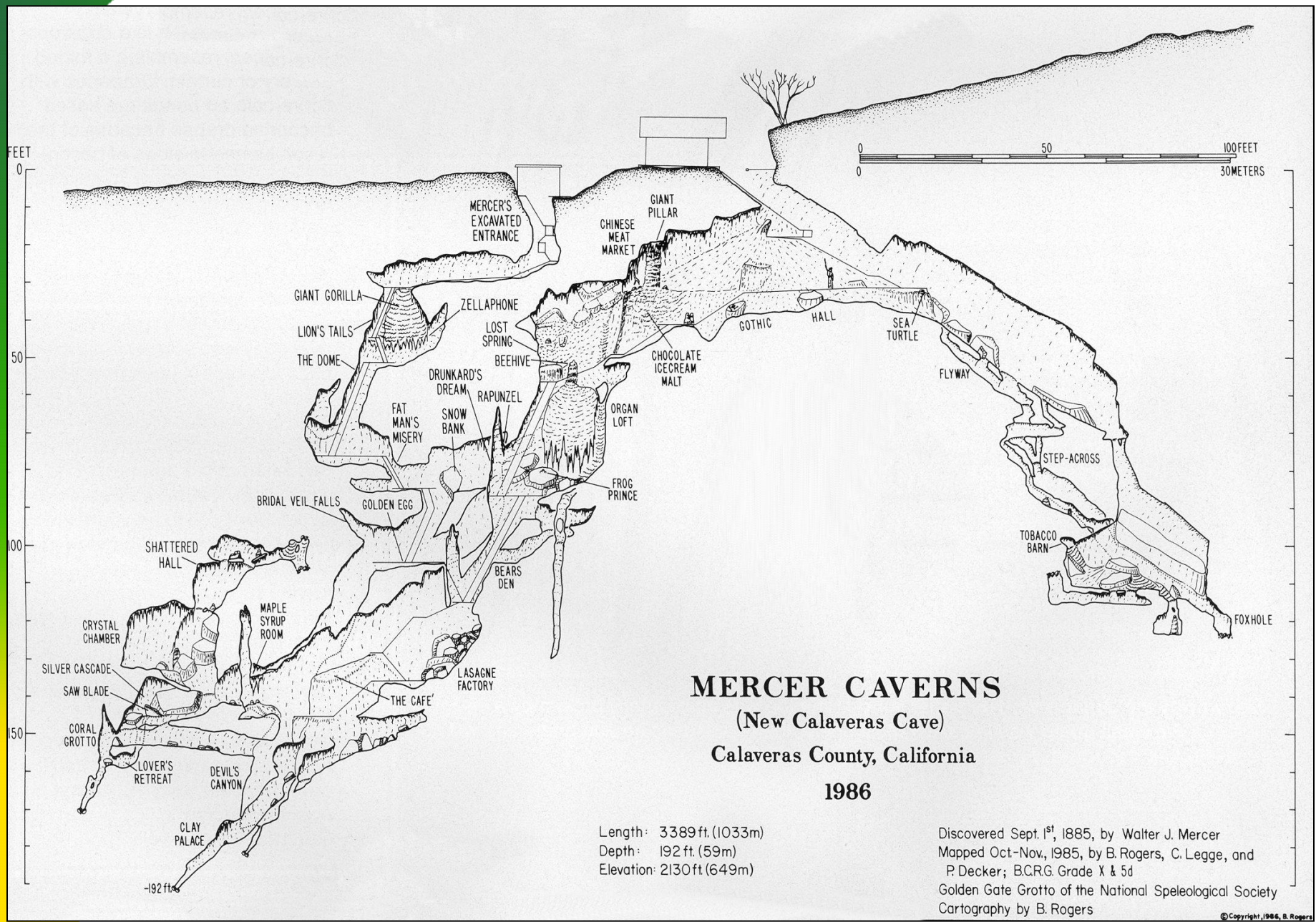

**MERCER CAVERNS**  
 (New Calaveras Cave)  
 Calaveras County, California  
 1986

Length: 3389 ft. (1033m)  
 Depth: 192 ft. (59m)  
 Elevation: 2130 ft. (649m)

Discovered Sept. 1<sup>st</sup>, 1885, by Walter J. Mercer  
 Mapped Oct.-Nov., 1985, by B. Rogers, C. Legge, and  
 P. Decker; B.C.R.G. Grade X & 5d  
 Golden Gate Grotto of the National Speleological Society  
 Cartography by B. Rogers

© Copyright, 1986, B. Rogers



# Section view of Mercer Caverns

# Mapping Underground Openings



- **Today underground surveying techniques utilize total station technology, Laser levels, and GPS, allowing for more accurate mapping than previously possible .**

# GROUND BASED LiDAR

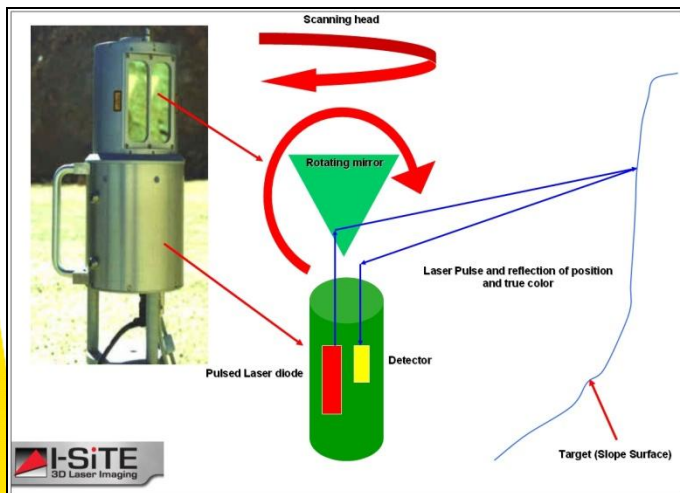
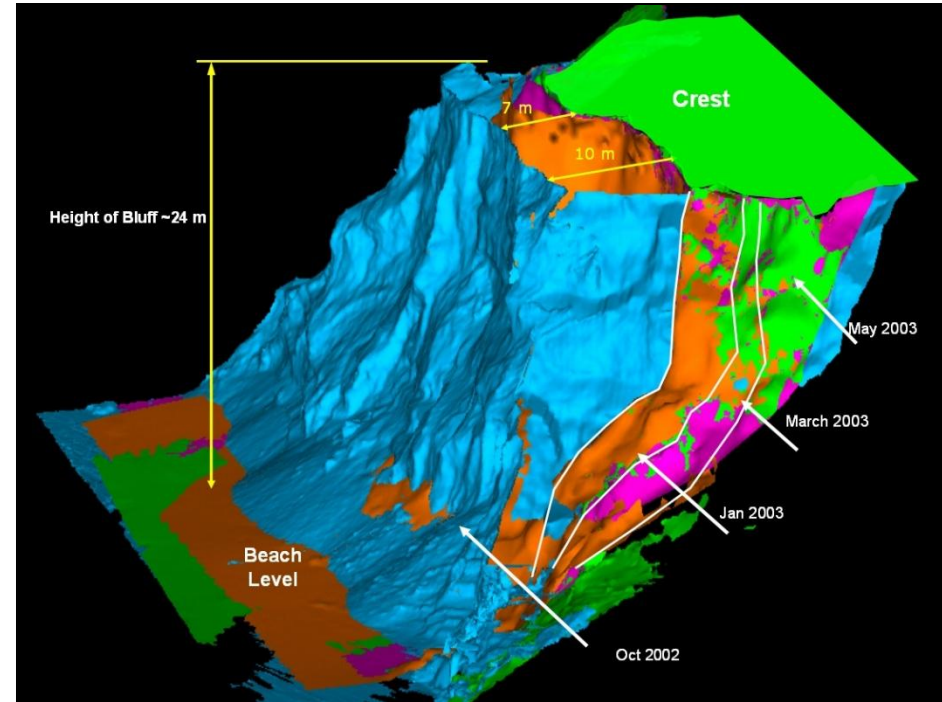

**Ground based LiDAR (Light Detection and Ranging) allows precise mapping of convoluted surfaces, such as bluffs or caverns.**



**Abandoned underground openings can be used for both conventional and irregular warfare, provided their whereabouts are known and accurately co-located**



# CONCLUSIONS

- **The Department of Defense will likely embark upon a program to inventory underground openings during the 21<sup>st</sup> Century.**
- **These will include ANYTHING that can shelter a terrorist, such as: basements, sewers/storm drains, underground tanks, buried pipelines, old and active transportation infrastructure, active and abandoned mines, and natural caverns.**