

This document downloaded from
vulcanhammer.net

since 1997,
your source for engineering information
for the deep foundation and marine
construction industries, and the historical
site for Vulcan Iron Works Inc.

Use subject to the “fine print” to the
right.

Don't forget to visit our companion site <http://www.vulcanhammer.org>

All of the information, data and computer software ("information") presented on this web site is for general information only. While every effort will be made to insure its accuracy, this information should not be used or relied on for any specific application without independent, competent professional examination and verification of its accuracy, suitability and applicability by a licensed professional. Anyone making use of this information does so at his or her own risk and assumes any and all liability resulting from such use. The entire risk as to quality or usability of the information contained within is with the reader. In no event will this web page or webmaster be held liable, nor does this web page or its webmaster provide insurance against liability, for any damages including lost profits, lost savings or any other incidental or consequential damages arising from the use or inability to use the information contained within.

This site is not an official site of Prentice-Hall, the University of Tennessee at Chattanooga, Vulcan Foundation Equipment or Vulcan Iron Works Inc. (Tennessee Corporation). All references to sources of equipment, parts, service or repairs do not constitute an endorsement.

INCH-POUND

MIL-HDBK-1007/3
15 NOVEMBER 1997

SUPERSEDING
NAVFAC DM-7.3
APRIL 1983

DEPARTMENT OF DEFENSE
HANDBOOK

SOIL DYNAMICS AND SPECIAL DESIGN ASPECTS



AMSC N/A

AREA FACR

DISTRIBUTION STATEMENT A. Approved for public release; distribution is unlimited.

ABSTRACT

This military handbook replaces the Naval Facilities Engineering Command (NAVFACENGCOM) design manual, DM-7.3. It contains material pertaining to soil dynamics, earthquake engineering, and special design aspects of geotechnical engineering. The soil dynamics section of this handbook deals with basic dynamic properties of soils, machine foundations, dynamic and vibratory compaction, and pile driving response. The earthquake engineering section deals with earthquake response spectra, site seismicity, design earthquake, seismic loads on structures, liquefaction, and base isolation. The special design aspects section deals with seismic design of anchored sheet pile walls, stone column and displacement piles, and dynamic slope stability and deformation. This military handbook is to be used by geotechnical engineers, working for the Department of Defense (DOD), for guidance in designing military facilities.

FOREWORD

This handbook for soil dynamics and special design aspects is one of a series that has been developed from an extensive re-evaluation of the relevant portions of soil dynamics, deep stabilization, and special geotechnical construction, from surveys of available new materials and construction methods, and from a selection of the best design practices of the Naval Facilities Engineering Command, other Government agencies, and private industries. This handbook includes a modernization of the former criteria and the maximum use of national professional society, association, and institute codes. Deviations from these criteria should not be made without the prior approval of the Naval Facilities Engineering Command.

Design cannot remain static any more than can the naval functions it serves, or the technologies it uses. Accordingly, this handbook cancels and supersedes DM 7.3 "Soil Dynamics, Deep Stabilization, and Special Geotechnical Construction" in its entirety, and changes issued.

Recommendations for improvement are encouraged from within the Navy, other Government agencies, and the private sector and should be furnished on the DD Form 1426 provided inside the back cover to Commander, Naval Facilities Engineering Command, Criteria Office, 1510 Gilbert Street, Norfolk, VA 23511-2699; telephone commercial (757) 322-4203, facsimile machine (757) 322-4416.

DO NOT USE THIS HANDBOOK AS A REFERENCE DOCUMENT FOR PROCUREMENT OF FACILITIES CONSTRUCTION. IT IS TO BE USED IN THE PURCHASE OF FACILITIES ENGINEERING CRITERIA STUDIES AND DESIGN (FINAL PLANS, SPECIFICATIONS, AND COST ESTIMATES). DO NOT REFERENCE IT IN MILITARY OR FEDERAL SPECIFICATIONS OR OTHER PROCUREMENT DOCUMENTS.

MIL-HDBK-1007/3

<u>Criteria Manual</u>	<u>Title</u>	<u>Preparing Activity</u>
DM-7.01	Soil Mechanics	NFESC
DM-7.02	Foundations and Earth Structures	NFESC
MIL-HDBK-1007/3	Soil Dynamics and Special Design Aspects	NFESC

SOIL DYNAMICS AND SPECIAL DESIGN ASPECTS

CONTENTS

Section 1	SOIL DYNAMICS	<u>Page</u>
1.1	Introduction.....	1
1.1.1	Scope.....	1
1.1.2	Related Criteria.....	1
1.1.3	Cancellation.....	2
1.2	BASIC DYNAMICS.....	3
1.2.1	Vibratory Motions.....	3
1.2.2	Mass, Stiffness, Damping.....	3
1.2.3	Amplification Function.....	6
1.2.4	Earthquake Ground Motions.....	8
1.3	SOIL PROPERTIES.....	9
1.3.1	Soil Properties for Dynamic Loading.....	9
1.3.2	Types of Soils.....	9
1.3.2.1	Dry and Partially Saturated Cohesionless Soils.....	11
1.3.2.2	Saturated Cohesionless Soils.....	11
1.3.2.3	Saturated Cohesive Soils.....	12
1.3.2.4	Partially Saturated Cohesive Soils.....	12
1.3.3	Measuring Dynamic Soil Properties.....	12
1.3.3.1	Field Measurements of Dynamic Modulus....	12
1.3.3.2	Laboratory Measurement of Dynamic Soil Properties.....	15
1.4	MACHINE FOUNDATIONS.....	19
1.4.1	Analysis of Foundation Vibration.....	19
1.4.1.1	Machine Foundations.....	19
1.4.1.2	Impact Loadings.....	19
1.4.1.3	Characteristics of Oscillating Loads.....	19
1.4.1.4	Method of Analysis.....	19
1.4.1.5	Dynamic Soil Properties.....	29
1.4.2	Design to Avoid Resonance.....	29
1.4.2.1	High-Speed Machinery.....	29
1.4.2.2	Low-Speed Machinery.....	30
1.4.2.3	Coupled Vibrations.....	30

	<u>Page</u>
1.4.2.4Effect of Embedment.....	32
1.4.2.5Proximity of a Rigid Layer.....	32
1.4.2.6Vibration for Pile Supported Machine Foundation.....	33
1.4.3 Bearing Capacity and Settlements.....	33
1.4.4 Vibration Transmission, Isolation, and Monitoring.....	37
1.4.4.1Vibration Transmission.....	37
1.4.4.2Vibration and Shock Isolation.....	39
1.4.4.3Vibration Monitoring.....	39
1.5 DYNAMIC AND VIBRATORY COMPACTION.....	40
1.5.1 Soil Densification.....	40
1.5.2 Vibro-Densification.....	40
1.5.3 Dynamic Compaction.....	40
1.5.4 Applications of Vibroflotation.....	43
1.5.5 Compaction Grout.....	43
1.5.6 Selecting a Method.....	46
1.6 PILE DRIVING RESPONSE.....	47
1.6.1 Wave Equation Analysis.....	47
1.6.2 Wave Propagation in Piles.....	47
1.6.3 Wave Equation Application.....	49
1.6.4 Dynamic Testing of Piles.....	49
1.6.5 Results From Dynamic Testing.....	51
1.6.6 Pile Dynamic Measurement.....	51
1.6.7 Applications.....	52
1.6.7.1Apparatus for Applying Impact Force.....	52
1.6.7.2Impact Force Application.....	52
1.6.7.3Apparatus for Obtaining Dynamic Measurement.....	53
1.6.7.4Signal Transmission.....	53
1.6.7.5Apparatus for Recording, Reducing, and Displaying Data.....	53

Section 2 **EARTHQUAKE ENGINEERING**

2.1 EARTHQUAKE, WAVES, AND RESPONSE SPECTRA..	54
2.1.1 Earthquake Mechanisms.....	54
2.1.2 Wave Propagation.....	55
2.1.3 The Response Spectrum.....	56

	<u>Page</u>
2.2	SITE SEISMICITY..... 61
2.2.1	Site Seismicity Study..... 61
2.2.2	Ground Motion Estimates..... 63
2.2.3	Analysis Techniques..... 64
2.3	SEISMIC SOIL RESPONSE..... 65
2.3.1	Seismic Response of Horizontally Layered Soil Deposits..... 65
2.3.2	Evaluation Procedure..... 65
2.3.3	Analysis Using Computer Program..... 66
2.4	DESIGN EARTHQUAKE..... 68
2.4.1	Design Parameters..... 68
2.4.1.1	Factors Affecting Ground Motion..... 68
2.4.1.2	Ground Motion Parameters..... 68
2.4.2	Site Specific Studies..... 69
2.4.3	Earthquake Magnitude..... 69
2.4.3.1	Design Earthquake Magnitude..... 73
2.4.3.2	Selection of Design Earthquake..... 73
2.4.4	Intensity..... 74
2.4.5	Peak Horizontal Ground Acceleration..... 74
2.4.6	Seismic Coefficients..... 76
2.4.7	Magnitude and Intensity Relationships.... 76
2.4.8	Reduction of Foundation Vulnerability to Seismic Loads..... 77
2.5	SEISMIC LOADS ON STRUCTURES..... 78
2.5.1	Earthquake Induced Loads..... 78
2.5.2	Foundation Loads..... 78
2.5.3	Wall Loads..... 78
2.5.4	Base Shear..... 78
2.6	LIQUEFACTION AND LATERAL SPREADING..... 80
2.6.1	Liquefaction Considerations..... 80
2.6.2	Factors Affecting Liquefaction..... 80
2.6.3	Evaluation of Liquefaction Potential..... 81
2.6.3.1	Simplified Empirical Methods..... 81
2.6.4	Peak Horizontal Acceleration..... 91
2.6.5	Laboratory Tests and Site Response Method..... 93
2.6.6	Slopes..... 93

	<u>Page</u>
2.6.6.1Pseudostatic Design.....	93
2.6.6.2Strain Potential Design.....	93
2.6.7 Lateral Spreading From Liquefaction.....	94
2.6.7.1Lateral Deformation.....	94
2.6.7.2Evaluation Procedure.....	94
2.6.7.3Application.....	95
2.7 FOUNDATION BASE ISOLATION.....	97
2.7.1 Seismic Isolation Systems.....	97
2.7.2 System Definitions.....	97
2.7.2.1Passive Control Systems.....	97
2.7.2.2Active Control Systems.....	97
2.7.2.3Hybrid Control Systems.....	98
2.7.3 Mechanical Engineering Applications.....	98
2.7.4 Historical Overview of Building Applications.....	98
2.7.5 Design Concept.....	98
2.7.6 Device Description.....	99
2.7.6.1Elastometer Systems.....	99
2.7.6.2Sliding System.....	99
2.7.6.3Hybrid Systems.....	99
2.7.6.4Applications.....	100
2.7.7 Examples of Applications.....	100
Section 3	
	SPECIAL DESIGN ASPECTS
3.1 SEISMIC DESIGN OF ANCHORED SHEET PILE WALLS.....	103
3.1.1 Design of Sheet Pile Walls for Earthquake.....	103
3.1.2 Design Procedures.....	103
3.1.3 Example Computation.....	105
3.1.4 Anchorage System.....	106
3.1.5 Ground Anchors.....	106

	<u>Page</u>
3.1.6	Displacement of Sheet Pile Walls.....117
3.2	STONE COLUMNS AND DISPLACEMENT PILES.....119
3.2.1	Installation of Stone Columns.....119
3.2.2	Parameters Affecting Design Consideration.....122
3.2.2.1	Soil Density.....122
3.2.2.2	Coefficient of Permeability.....122
3.2.2.3	Coefficient of Volume Compressibility....122
3.2.2.4	Selection of Gravel Material.....122
3.2.3	Vibro-Replacement (Stone Columns).....123
3.2.4	Vibroflotation and Vibro-Replacement.....123
3.3	DYNAMIC SLOPE STABILITY AND DEFORMATIONS.....125
3.3.1	Slope Stability Under Seismic Loading...125
3.3.2	Seismically Induced Displacement.....125
3.3.3	Slopes Vulnerable to Earthquakes.....125
3.3.4	Deformation Prediction From Acceleration Data.....126
3.3.4.1	Computation Method.....126
3.3.4.2	Sliding Rock Analogy.....126

APPENDICES

APPENDIX A	Computer Programs.....132
APPENDIX B	Symbols.....136

FIGURES

Figure 1	Free Vibration of Simple System.....	5
2	Relation Between Number of Blows Per Foot in Standard Penetration Test and Velocity of Shear Waves.....	10
3	Laboratory Measurement of Dynamic Soil Properties.....	18
4	Wave Forms of Vibrations Generated From Rotating and Impact Machinery.....	20
5	Frequency Dependent and Constant Amplitude Exciting Forces.....	21

		<u>Page</u>
6	Modes of Vibration.....	22
7	Response Curves for Single-Degree-of-Freedom System With a Viscous Damping....	25
8	Example Calculation of Vertical, Horizontal, and Rocking Motions.....	26
9	Natural Undamped Frequency of Point Bearing Piles on Rigid Rock.....	31
10	Example Calculation for Vibration Induced Compaction Settlement Under Operating Machinery.....	36
11	Allowable Amplitude of Vertical Vibrations.....	38
12	Grain Size Ranges Considered for Vibro-Densification.....	41
13	Relative Density vs. Probe Spacing for Soil Densification.....	45
14	Formulation of Pile into a Dynamic Model to Solve the Wave Equation.....	48
15	Example of Force and Velocity Near to Head of Pile During Driving.....	50
16	Tripartite Diagram of Response Spectra - 5 Percent Damping.....	59
17	Definition of Earthquake Terms.....	62
18	Schematic Representation of Procedure for Computing Effects of Local Soil Conditions on Ground Motions.....	67
19	Example of Attenuation Relationships in Rock.....	70
20	Approximate Relationship for Maximum Acceleration in Various Soil Conditions Knowing Maximum Acceleration in Rock.....	71
21	Example Probability of Site Acceleration.	72
22	Approximate Relationships Between Maximum Acceleration and Modified Mercalli Intensity.....	75
23	Correlation Between C_N and Effective Overburden Pressure.....	84
24	Cyclic Resistance Ratio (CRR) for Clean Sands Under Level Ground Conditions Based on SPT.....	86

		<u>Page</u>
25	Cyclic Resistance Ratio (CRR) for Clean Sands Under Level Ground Conditions Based on CPT.....	87
26	Correction to SPT and CPT Values for Fine Contents.....	89
27	Range of Magnitude Scaling Factors for Correction of Earthquake Magnitudes.....	90
28	Correction (KC) to CPT Penetration Resistance in Thin Sand Layers.....	92
29	The Base Isolation System.....	101
30	The Acceleration Spectrum Showing Period Shift.....	102
31	Measured Distributions of Bending Moment in Three Model Tests on Anchored Bulkhead.....	104
32	Example of Anchored Sheet Pile Wall Design.....	107
33	Basic Components of Ground Anchors.....	113
34	Estimate of Anchor Capacity.....	114
35	Installation of Stone Columns.....	120
36	Typical Range of Soils Densifiable by Vibro-Replacement.....	121
37	Prediction of Embankment Deformation Induced by Earthquake.....	127
38	Principle Components of the Sliding Block Analysis.....	128
A-1	Example of Liquefaction Potential Analysis Output.....	133
A-2	Example of LIQUFAC Analysis Graphic Plot.....	134
A-3	Example of LATDEF2 Data Input Screen....	135

TABLES

Table 1	Attenuation Coefficient for Earth Materials.....	37
2	Dynamic Compaction.....	42
3	Examples of Vibroflotation Patterns and Spacings for Footings.....	44

	<u>Page</u>
4	Spectral Ordinates - 5 Percent Damping..... 60
5	Peak Ground Acceleration Modified for Soil Conditions..... 76
6	Energy Ratio for SPT Procedures..... 85
7	Types of Soil Anchors.....116
8	Description of the Reported Degree of Damage for Sheet Pile Wall.....118
9	Vibro-Replacement for Stone Column.....124
REFERENCES138
GLOSSARY142

Section 1: SOIL DYNAMICS

1.1 INTRODUCTION

1.1.1 Scope. This handbook is concerned with geotechnical problems associated with dynamic loads, and with earthquake related ground motion and soil response induced by earthquake loads. The dynamic response of foundations and structures depends on the magnitude, frequency, direction, and location of the dynamic loads; the geometry of the soil-foundation contact system; and the dynamic properties of the supporting soils and structures. Dynamic ground motions considered in this chapter are those generated from machine foundations and impact loading. An example calculation of vertical, horizontal, and rocking motions induced by machinery vibration is included. Soil compaction resulting from dynamic impact and dynamic response induced by impact loading on piles are also included. An example calculation of dynamic compaction procedures for soils and an example of pile driving analysis are included.

Elements in a seismic response analysis are: input motions, site profile, static and dynamic soil properties, constitutive models of soil response to loading, and methods of analysis using computer programs. The contents include: earthquake response spectra; site seismicity; soil response to seismic motion, design earthquake, seismic loads on structures, liquefaction potential, lateral spread from liquefaction, and foundation base isolation.

Some special problems in geotechnical engineering dealing with soil dynamics and earthquake aspects are discussed. Its contents include: seismic design of anchored sheet pile walls, stone columns and displacement piles; and dynamic slope stability and deformations induced by earthquakes

1.1.2 Related Criteria. Additional criteria relating to dynamics appear in the following sources:

MIL-HDBK-1007/3

<u>Subject</u>	<u>Source</u>
<u>Soil Mechanics</u>	NAVFAC DM-7.1
<u>Foundations and Earth Structures</u>	NAVFAC DM-7.2
<u>Structures to Resist the</u>	NAVFAC P-397
<u>Effects of Accidental Explosions</u>	
<u>Seismic Design Guidelines</u>	TM 5-890-10-1/NAVFAC
<u>for Essential Buildings</u>	P-355.1/AFN 88-3

Additional information related to special design aspects are included in the References section at the end of this handbook.

1.1.3 Cancellation. This handbook, MIL-HDBK-1007/3, dated 15 November 1997, cancels and supersedes NAVFAC DM-7.3, dated April 1983.

1.2 BASIC DYNAMICS

1.2.1 Vibratory Motions. Harmonic or sinusoidal motion is the simplest form of vibratory motion. An idealized simple harmonic motion may be described by the equation:

$$z = A \sin(\omega t - \psi)$$

where: z = displacement
 A = single amplitude
 ω = circular frequency
 t = time
 ψ = phase angle

For simple harmonic motion the displacement amplitude, the phase angle, and the frequency are all that are needed to determine the complete history of motions. For motion other than harmonic motion, simple relationships usually do not exist between displacement, velocity, and acceleration, and the conversion from one quantity to the other must be accomplished by differentiation or integration of the equation of motion or by other mathematical manipulation.

The displacements described by the above equation will continue oscillating forever. In reality the amplitude of the motions will decay over time due to the phenomenon called damping. If the damping is similar to that caused by a dashpot with constant viscosity, it is said to be linearly viscous damping, and the amplitude decays exponentially with time. If the damping is similar to that caused by a constant coefficient of friction, it is said to be linearly hysteric damping, and the amplitude decays linearly with time. All systems exhibit complicated combinations of various forms of damping, so any mathematical treatment is a convenient approximation to reality.

1.2.2 Mass, Stiffness, Damping. Dynamic analysis begins with a single-degree-of-freedom (SDOF) system illustrated in Figure 1 (A). A mass is attached to a linear spring and a linear dashpot. The sign convention is that displacements and forces are positive to the right.

If the mass M is accelerating to the right the force to cause this acceleration must be:

$$F_a = m a = m d^2u/dt^2 = m \ddot{U}$$

The dots are used to indicate differentiation with respect to time; this simplifies writing the equations.

The linear dashpot has a restoring force that is proportional to the velocity of motion and acts in the opposite sense. This means that:

$$F_d = -c du/dt = -c \dot{U}$$

Finally, there may be some force P , which is a function of time, that is applied directly to the mass.

.. Adding the three forces together, setting the sum equal to μu , and rearranging terms gives the basic equation for an SDOF system:

$$m \ddot{U} + c \dot{U} + k U = P$$

This equation applies to linear systems; for other types of systems, the equation has to be modified or the terms must be variable. Also, when the motion involves rotation instead of translation, the displacements, velocities, and accelerations must be replaced with rotations and angular velocities and accelerations, and the other terms also modified appropriately.

In most practical cases the mass m and the stiffness k can be determined physically. It is often possible to measure them directly. On the other hand, the damping is a mathematical abstraction used to represent the fact that the vibration energy does decay. It is difficult if not impossible to measure directly and, in some cases to be discussed below, it describes the effects of geometry and has nothing to do with the energy absorbing properties of the material.

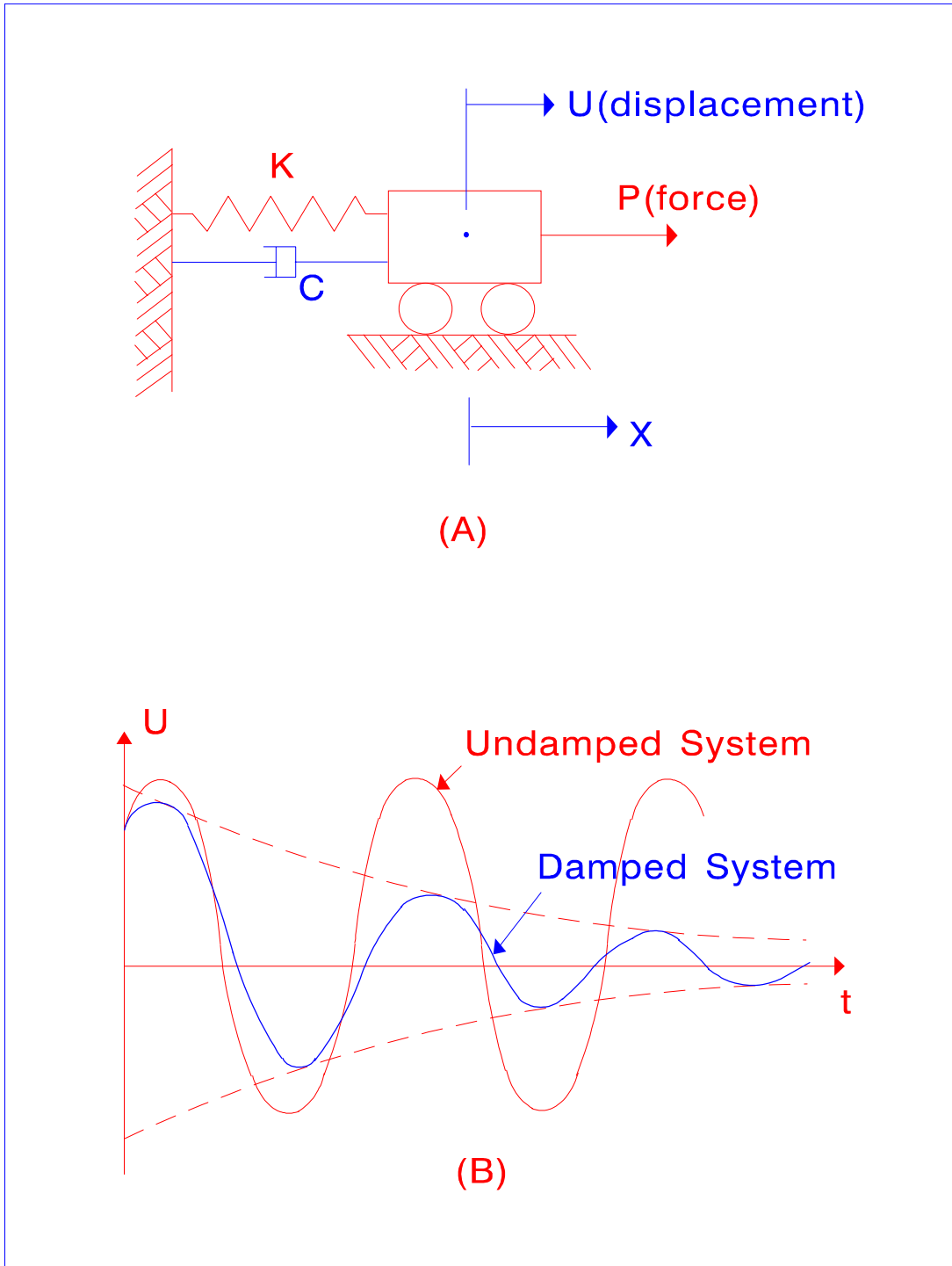

Figure 1
Free Vibration of Simple System

In the case of no external force and no damping, the motion of the mass will be simple harmonic motion. The frequency ω_0 will be:

$$\omega_0 = (k/m)^{1/2}$$

If the damping is not zero and the mass is simply released from an initial displacement U_0 with no external force, the motion will be as shown in Figure 1 (B). The frequency of the oscillations will be ω_e :

$$\omega_e^2 = \omega_0^2 - (c/2m)^2$$

When $c = 2(km)^{1/2}$, there will be no oscillations, but the mass will simply creep back to the at rest position at infinite time. This is called critical damping, and it is written c_{cr} . The ratio of the actual damping to the critical damping is called the critical damping ratio D :

$$D = c/c_{cr}$$

If the basic equation is divided through by m , it can be written as:

$$\ddot{U} + 2D \omega_0 \dot{U} + \omega_0^2 U = P/m$$

The frequency of oscillations can be written:

$$\omega = \omega_0 (1-D^2)^{1/2}$$

In almost all practical cases, D is much less than 1. For example, a heavily damped system might have a D of 0.2 or 20 percent. In that case ω is 98 percent of ω_0 , so little error is introduced by using the undamped frequency ω_0 in place of the damped frequency ω .

1.2.3 Amplification Function. If now the SDOF system is driven by a sinusoidally varying force, the right side of the basic equation becomes:

$$R = F \cos(\omega t)$$

For a very low frequency, this becomes a static load, and:

$$u = F/k = A_s$$

A_s is the static response.

In the dynamic case, after the transient portion of the response has damped out, the steady state response becomes:

$$u = M A_s \cos(\omega t - p)$$

In this equation M is called the dynamic amplification factor and p is the phase angle. The dynamic amplification factor is the ratio of the amplitude of the dynamic steady-state response to the static response and describes how effectively the SDOF amplifies or de-amplifies the input. The phase angle p indicates how much the response lags the input.

Mathematical manipulation reveals that:

$$M = \frac{1}{\{(1 - \omega^2/\omega_o^2)^2 + [(2D)\omega/\omega_o]^2\}^{1/2}}$$

and

$$p = \tan^{-1} \frac{2D(\omega/\omega_o)}{1 - \omega^2/\omega_o^2}$$

The amplification factor M is plotted in Figure 7 (A). Note that the ratio of frequencies is the same regardless of whether they are expressed in radian/second or cycles/second.

When the problem involves rotating machinery, the amplitude of the driving force is proportional to the frequency of the rotating machinery. If e is the eccentricity of the rotating mass and m_e is its mass, then the amplitude of the driving force becomes:

$$F = m_e e \omega^2$$

In this case the driving force vanishes when the frequency goes to zero, so it does not make sense to talk about a static response. However, at very high frequencies the acceleration dominates, so it is possible to define the high frequency response amplitude R :

$$R = m_e (e/M)$$

As in the case of the sinusoidal loading, the equations can be solved to give an amplification ratio. This is now the ratio of the amplitude of the response to the high-frequency response R . The curve is plotted in Figure 7 (B).

An important point is that the response ratio gives the amplitude of the displacement response for either case. To find the amplitude of the velocity response, the displacement response is multiplied by ω (or $2\pi f$). To find the amplitude of the acceleration response, the displacement response is multiplied by ω^2 (or $4\pi^2 f^2$).

1.2.4 Earthquake Ground Motions. Earthquake ground motions, which cause dynamic loads on the foundation and structures, are transient and may or may not occur several times during the design life of the structures. This subject will be covered in more detail in paragraphs 2.1 through 2.7.

1.3 SOIL PROPERTIES

1.3.1 Soil Properties for Dynamic Loading. The properties that are most important for dynamic analyses are the stiffness, material damping, and unit weight. These enter directly into the computations of dynamic response. In addition, the location of the water table, degree of saturation, and grain size distribution may be important, especially when liquefaction is a potential problem.

One method of direct determination of dynamic soil properties in the field is to measure the velocity of shear waves in the soil. The waves are generated by impacts produced by a hammer or by detonating charges of explosives, and the travel times are recorded. This is usually done in or between bore holes. A rough correlation between the number of blows per foot in standard penetration tests and the velocity of shear waves is shown in Figure 2 (Proposed by Imai and Yoshimura 1970 and Imai and Tonouchi 1982).

1.3.2 Types of Soils. As in other areas of soil mechanics, the type of the soil affects its response and determines the type of dynamic problems that must be analyzed. The most significant factors separating different types of soils are the grain size distribution, the presence or absence of a clay fraction, and the degree of saturation. It is also important to know whether the dynamic loading is a transient phenomenon, such as a blast loading or earthquake, or is a long term phenomenon, like a vibratory loading from rotating machinery. The distinction is important because a transient dynamic phenomenon occurs so rapidly that excess pore pressure does not have time to dissipate except in the case of very coarse, clean gravels. In this context the length of the drainage path is also important; even a clean, granular material may retain large excess pore pressure if the drainage path is so long that the pressures cannot dissipate during the dynamic loading. Thus, the engineer must categorize the soil by asking the following questions:

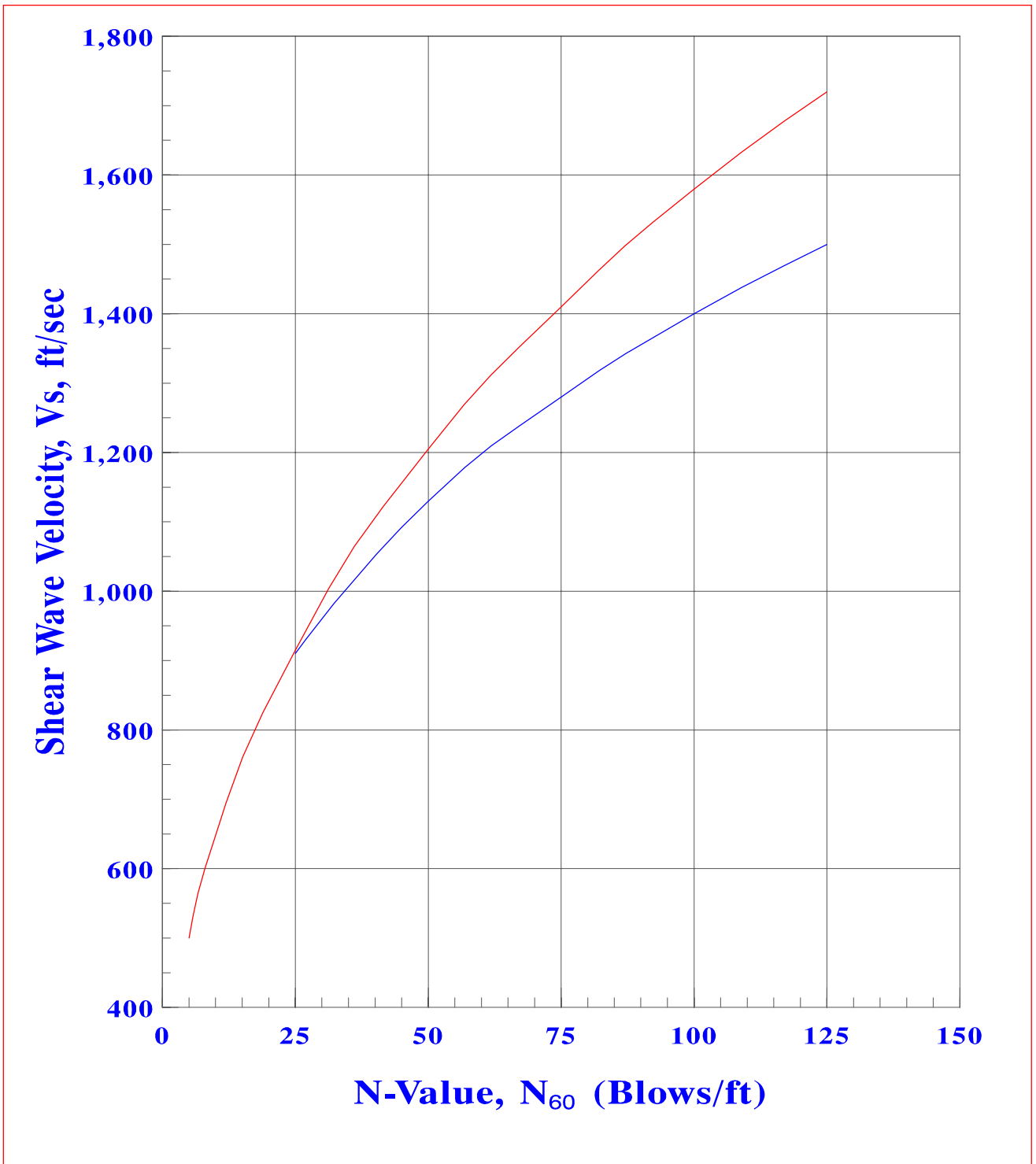

Figure 2
Relation Between Number of Blows Per Foot in Standard Penetration Test and Velocity of Shear Waves

a) Is the material saturated? If it is saturated, a transient dynamic loading will usually last for such a short time that the soil's response will be essentially undrained. If it is not saturated, the response to dynamic loadings will probably include some volumetric component.

b) Are there fines present in the soil? The presence of fines, especially clays, not only inhibits the dissipation of excess pore pressure, it also decreases the tendency for liquefaction.

c) How dense is the soil? Dense soils are not likely to collapse under dynamic loads, but loose soils may. Loose soils may densify under vibratory loading and cause permanent settlements.

d) How are the grain sizes distributed? Well graded materials are less susceptible to losing strength under dynamic loading than uniform soils. Loose, uniform soils are especially subject to collapse and failure.

1.3.2.1 Dry and Partially Saturated Cohesionless Soils. There are three types of dry or a partially saturated cohesionless soils. The first type comprises soils that consist essentially of small-sized to medium-sized grains of sufficient strength or under sufficiently small stresses, so that grain breakage does not play a significant role in their behavior. The second type includes those soils made up essentially of large-sized grains, such as rockfills. Large-sized grains may break under large stresses and overall volume changes are significantly conditioned by grain breakage. The third type includes fine-grained materials, such as silt. The behavior of the first type of dry cohesionless soils can be described in terms of the critical void ratio. The behavior of the second type depends on the normal stresses and grain size. If the water or air cannot escape at a sufficiently fast rate when the third type of soil is contracting due to vibration, significant pore pressures may develop, with resulting liquefaction of the material.

1.3.2.2 Saturated Cohesionless Soils. If pore water can flow in and out of the material at a sufficiently high rate so that appreciable pore pressures do not develop, behavior of these

soils does not differ qualitatively from that of partially saturated cohesionless soils. If the pore water cannot flow in or out of the material, cyclic loads will usually generate increased pore pressure. If the soil is loose or contractive, the soil may liquefy.

1.3.2.3 Saturated Cohesive Soils. Alternating loads decrease the strength and stiffness of cohesive soils. The decrease depends on the number of repetitions, the relative values of sustained and cycling stresses, and the sensitivity of the soil. Very sensitive clays may lose so much of their strength that there may be a sudden failure. The phenomenon is associated with a reduction in effective pressure as was the case with cohesionless soils.

1.3.2.4 Partially Saturated Cohesive Soils. The discussion in connection with saturated cohesive soils applies to insensitive soils when they are partially saturated, except that the possibility of liquefaction seems remote.

1.3.3 Measuring Dynamic Soil Properties. Soil properties to be used in dynamic analyses can be measured in the field or in the laboratory. In many important projects a combination of field and laboratory measurements are used.

1.3.3.1 Field Measurements of Dynamic Modulus. Direct measurement for soil or rock stiffness in the field has the advantage of minimal material disturbance. The modulus is measured where the soil exists. Furthermore, the measurements are not constrained by the size of a sample.

Moduli measured in the field correspond to very small strains. Although some procedures for measuring moduli at large strain have been proposed, none has been found fully satisfactory by the geotechnical engineering community. Since the dissipation of energy during strain, which is called material damping, requires significant strains to occur, field techniques have also failed to prove effective in measuring material damping.

In situ techniques are based on measurement of the velocity of propagation of stress waves through the soil. Because the P-waves or compression waves are dominated by the response of the pore fluid in saturated soils, most techniques measure the S-waves or shear waves. If the velocity of the shear wave through a soil deposit is determined to be V_s , the shear modulus G is:

$$G = \rho V_s^2 = \frac{\gamma}{g} V_s^2$$

where: ρ = mass density of the soil

V_s = shear wave velocity

γ = unit weight of the soil

g = acceleration of gravity

The techniques for measuring shear wave velocity in situ fall into three categories: cross-hole, down-hole, and up-hole. All require that borings be made in the soil.

In the cross-hole method sensors are placed at one elevation in one or more borings and a source of energy is triggered in another boring at the same elevation. The waves travel horizontally from the source to the receiving holes. The arrivals of the S-waves are noted on the traces of the response of the sensors, and the velocity can be calculated by dividing the distance between borings by the time for a wave to travel between them. Because it can be difficult to establish the exact triggering time, the most accurate measurements are obtained from the difference of arrival times at two or more receiving holes rather than from the time between the triggering and the arrival at single hole.

Since P-waves travel faster than S-waves, the sensors will already be excited by the P-waves when the S-waves arrived. This can make it difficult to pick out the arrival of the S-wave. To alleviate this difficulty it is desirable to use an energy source that is rich in the vertical shear component of motion and relatively poor in compressive motion. Several devices are available that do this. The original cross-hole

velocity measurement methods used explosives as the source of energy, and these were rich in compression energy and poor in shear energy. It is quite difficult to pick out the S-wave arrivals in this case, and explosives should not be used as energy sources for cross-hole S-wave velocity measurements today. ASTM D 4428/D 4428M, Cross-Hole Seismic Testing, describes the details of this test.

In the down-hole method the sensors are placed at various depths in the boring and the source of energy is above the sensors - usually at the surface. A source rich in S-waves should be used. This technique does not require as many borings as the cross-hole method, but the waves travel through several layers from the source to the sensors. Thus, the measured travel time reflects the cumulative travel through layers with different wave velocities, and interpreting the data requires sorting out the contribution of the layers. The seismocone version of the cone penetration test is one example of the down-hole method.

In the up-hole method the source of the energy is deep in the boring and the sensors are above it - usually at the surface.

A recently developed technique that does not require borings is the spectral analysis of surface waves (SASW). This technique uses sensors that are spread out along a line at the surface, and the source of energy is a hammer or tamper also at the surface. The surface excitation generates surface waves, in particular Rayleigh waves. These are waves that occur because of the difference in stiffness between the soil and the overlying air. The particles move in retrograde ellipses whose amplitudes decay from the surface. The test results are interpreted by recording the signals at each of the receiving stations and using a computer program to perform a spectral analysis of the data. Computer programs have been developed that will determine the shear wave velocities from the results of the spectral analysis.

The SASW method is most effective for determining properties near the surface. To increase the depth of the measurements the energy at the source must be increased. Measurements for the few feet below the surface, which may be

adequate for evaluating pavements, can be accomplished with a sledge hammer as a source of energy, but measurements several tens of feet deep require track-mounted seismic "pingers." The SASW method works best in cases where the stiffness of the soils

and rocks increases with depth. If there are soft layers lying under stiff ones, the interpretation may be ambiguous. A soft layer lying between stiff ones can cause problems for the cross-hole method as well because the waves will travel fastest through the stiff layers and the soft layer may be masked.

The cross-hole, down-hole, and up-hole methods may not work well very near the surface, where the complications due to surface effects may affect the readings. This is the region where the SASW method should provide the best result. The cross-hole technique employs waves with horizontal particle motion, the down-hole and up-hole methods use waves whose particle motions are vertical or nearly so, and the surface waves in the SASW method have particle motions in all sensors. Therefore, a combination of these techniques can be expected to give a more reliable picture of the shear modulus than any one used alone.

1.3.3.2 Laboratory Measurement of Dynamic Soil Properties.

Laboratory measurements of soil properties can be used to supplement or confirm the results of field measurements. They can also be necessary to establish values of damping and modulus at strains larger than those that can be attained in the field or to measure the properties of materials that do not now exist in the field, such as soils to be compacted.

A large number of laboratory tests for dynamic purposes have been developed, and research continues in this area. These tests can generally be classified into two groups: those that apply dynamic loads and those that apply loads that are cyclic but slow enough that inertial effects do not occur.

The most widely used of the laboratory tests that apply dynamic loads is the resonant-column method, described by ASTM D 4015, Modulus and Damping of Soils by the Resonant-Column Method. In this test a column of soil is subjected to an oscillating longitudinal or torsional load. The frequency is varied until resonance occur. From the frequency and amplitude

at resonance the modulus and damping of the soil can be calculated. A further measure of the damping can be obtained by observing the decay of oscillations when the load is cut off.

ASTM D 4015 describes only one type of resonant-column device, but there are several types that have been developed. These devices provide measurements of both modulus and damping at low strain levels. Although the strains can sometimes be raised a few percent, they remain essentially low strain devices. The torsional devices give measurements on shear behavior, and the longitudinal devices give measurements pertaining to extension and compression behavior.

The most widely used of the cyclic loading laboratory tests is the cyclic triaxial test, described in ASTM D 3999, Determination of the Modulus and Damping Properties of Soils Using the Cyclic Triaxial Apparatus. In this test a cyclic load is applied to a column of soil over a number of cycles slowly enough that inertial effects do not occur. The response at one amplitude of load is observed, and the test is repeated at a higher load. Figure 3 (A) shows the typical pattern of stress and strain, expressed as shear stress and shear strain. The shear modulus is the slope of the secant line inside the loop. The critical damping ratio, D , is:

$$D = \frac{A_i}{4 \pi A_r}$$

where: A_i = area of the loop

A_r = shaded area

Other types of cyclic loading devices also exist, including cyclic simple shear devices. Their results are interpreted similarly. These devices load the sample to levels of strain much larger than those attainable in the resonant-column devices. A major problem in both resonant-column and cyclic devices is the difficulty of obtaining undisturbed samples. This is especially true for small-strain data because the effects of sample disturbance are particularly apparent at small strains.

The results of laboratory tests are often presented in a form similar to Figure 3 (B-1 and B-2). In Figure 3 (B-1) the ordinate is the secant modulus divided by the modulus at small strains. In Figure 3 (B-2) the ordinate is the value of the initial damping ratio. Both are plotted against the logarithm of the cyclic strain level.

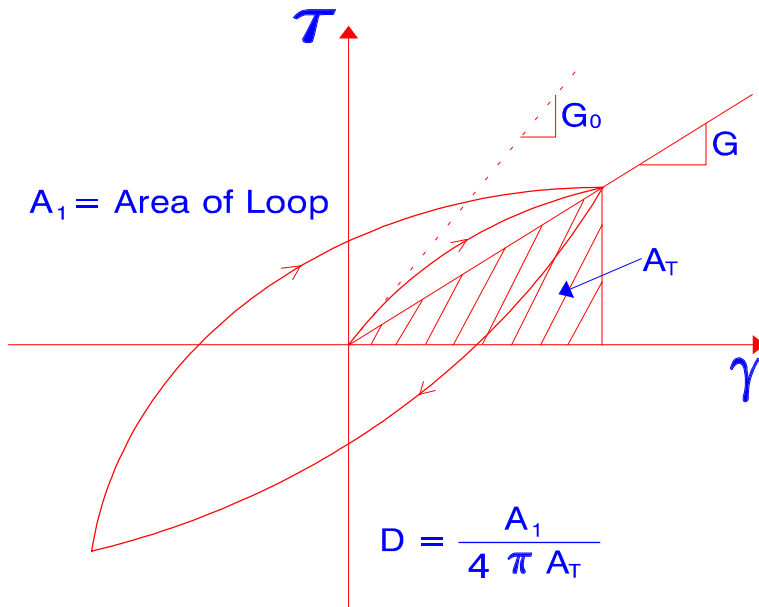

(A) Typical Pattern of Shear Stress and Shear Strain

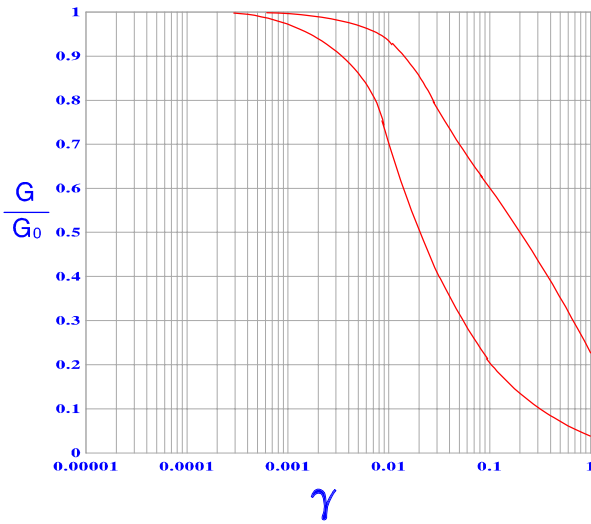

(B-1) Cyclic Shear Strain vs. the Ratio of Secant Modulus and the Modulus of Small Strain

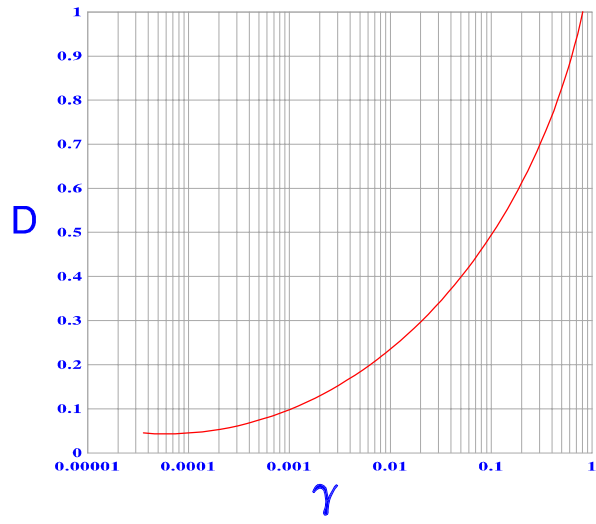

(B-2) Cyclic Shear Strain vs. the Value of Initial Damping Ratio

Figure 3
Laboratory Measurement of Dynamic Soil Properties
18

1.4 MACHINE FOUNDATIONS

1.4.1 Analysis of Foundation Vibration. Types of foundation vibration are given below.

1.4.1.1 Machine Foundations. Operation of machinery can cause vibratory motions in the foundations and soils. The pattern of the applied load versus time will be repeated for many cycles. Figure 4 shows wave forms of vibrations generated from rotating and impact machinery. The vibration may be irregular as shown in Figure 4 (A). In this case, it is often idealized into a simple form as shown in Figure 4 (B). These loads are generally assumed to persist during the design life of the structure.

1.4.1.2 Impact Loadings. Impact loading is generally transient. Typical examples are those generated by pile driving, heavy tamping, and blasting. Figure 4 (C) shows impact generated wave form. Criteria for blast loadings on structures are covered in NAVFAC P-397.

1.4.1.3 Characteristics of Oscillating Loads. Although there is a transient portion of the response as an oscillating load starts, the most important response to oscillating loads usually occurs when the load is maintained at steady state. As discussed in par. 2.3, there are two basic types of oscillating loads. In the first, the load is a sinusoidal function at constant amplitude with an amplitude that is independent of frequency. In the second, the load is a sinusoidal function, but the amplitude depends on frequency. The latter is the case for rotating machinery, where the load is proportional to the eccentric mass, the moment arm of the eccentric mass, and the frequency of operation. Figure 5 shows an example of impact and rotating machinery vibration forces.

1.4.1.4 Method of Analysis. Machine induced foundation vibrations are analyzed as follows:

a) Simplify the actual foundation geometry and soil properties into an SDOF system, involving a spring constant K and damping ratio D . Compute spring constant K and damping ratio D for anticipated modes of vibration. Figure 6 shows examples of modes of vibration.

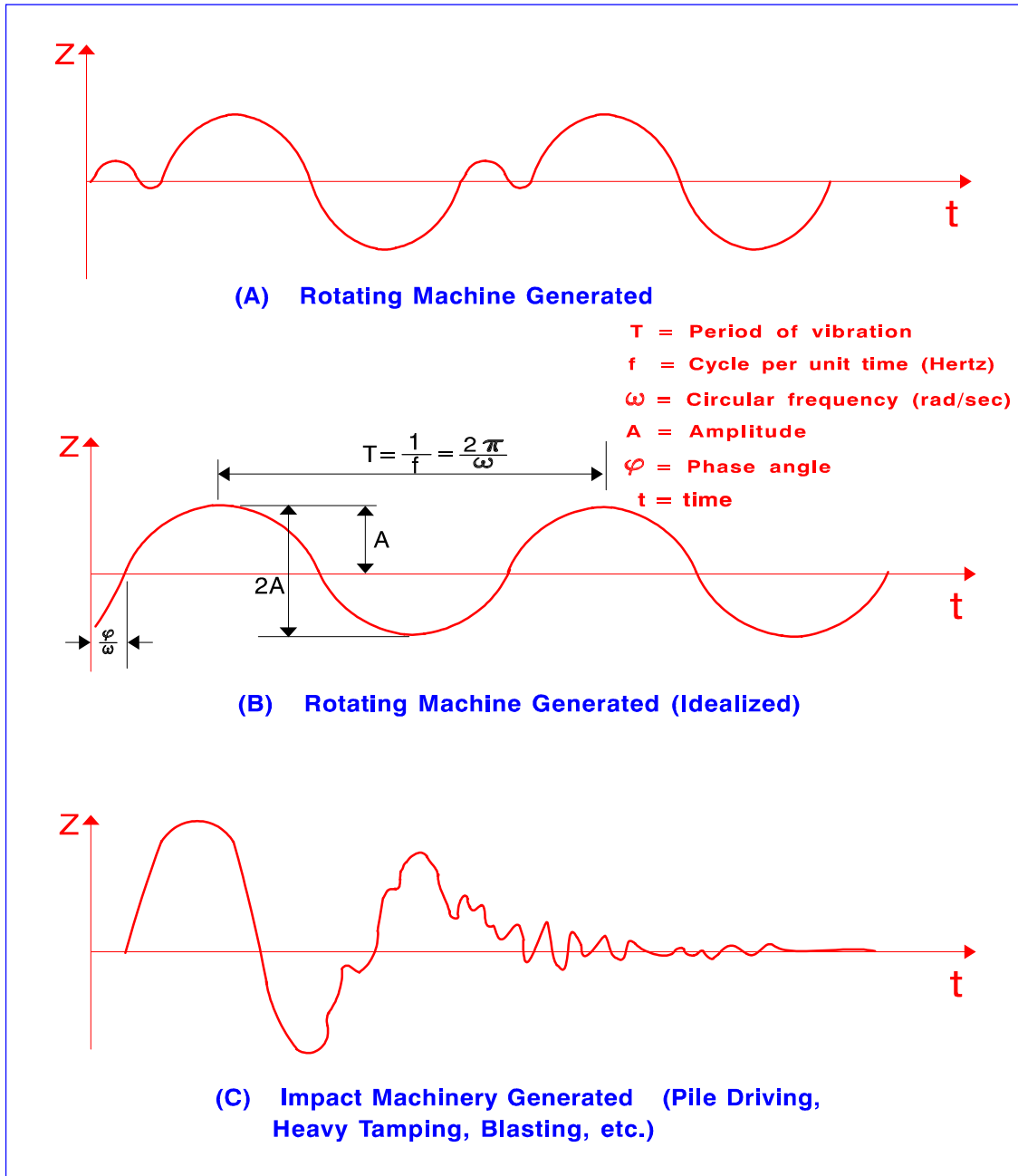
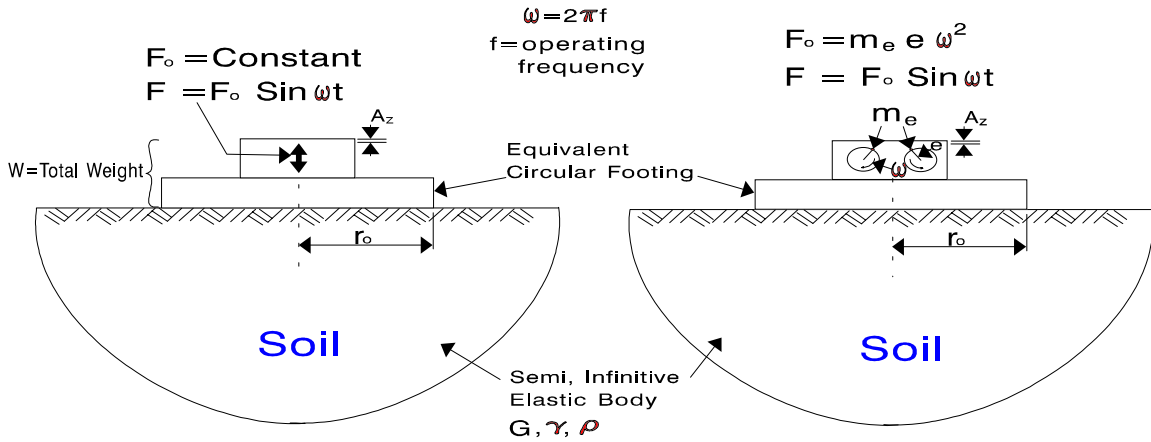

Figure 4
Wave Forms of Vibrations Generated From Rotating and Impact Machinery



Impact Machinery Vibration

Rotating Machinery Vibration

Definitions:

A_z = Vibration amplitude

ν = Poissons Ratio

m = Mass of Foundation and Machine

ρ = Foundation mass density = $\frac{\gamma_t}{g}$

r_o = Effective Radius = $\sqrt{\frac{B \cdot L}{\pi}}$ for vertical or horizontal translation

$$= \left(\sqrt{\frac{B \cdot L^3}{3 \cdot \pi}} \right)^{\frac{1}{2}} \quad \text{for rocking}$$

$$= \left(\sqrt{\frac{B \cdot L \cdot (B^2 + L^2)}{6 \cdot \pi}} \right)^{\frac{1}{2}} \quad \text{for torsion}$$

B = Width of foundation (along axis of rotation for case of rocking)

L = Length of foundation (in plane of rotation or rocking)

I_ψ = Mass moment of inertia around axis of rotation for rocking

I_θ = Mass moment of inertia around axis of rotation for torsion

G = Dynamic shear modulus

ω = Frequency of forced vibration (radians/sec)

Figure 5

Frequency Dependent and Constant Amplitude Exciting Forces

Mode of Vibration	Mass (or Inertia) Ratio	Damping Coefficient	Damping Ratio $D := \frac{C}{\sqrt{Km}}$	Spring Constant K
Vertical	$B_z := \frac{1-v}{4} \cdot \frac{m}{\rho \cdot (ro)^3}$	$C_z := \frac{3.4 \cdot (ro)^2}{1-v} \cdot \sqrt{\rho \cdot G}$	$D_z := \frac{0.425}{\sqrt{B_z}}$	$K_z := \frac{4 \cdot G \cdot ro}{1-v}$
Horizontal Sliding	$B_x := \frac{(7-8v)}{32(1-v)} \cdot \frac{m}{\rho \cdot (ro)^3}$	$C_x := \frac{4.6 \cdot (ro)^2}{2-v} \cdot \sqrt{\rho \cdot G}$	$D_x := \frac{0.288}{\sqrt{B_x}}$	$K_x := \frac{32(1-v) \cdot G \cdot ro}{7-8v}$
Rocking	$B_\psi := \frac{3 \cdot (1-v)}{4} \cdot \frac{I_\psi}{\rho \cdot (ro)^5}$	$C_\psi := \frac{0.8 \cdot (ro)^4}{(1-v) \cdot (1+B_\psi)} \cdot \sqrt{\rho \cdot G}$	$D_\psi := \frac{0.15}{(1+B_\psi) \cdot \sqrt{B_\psi}}$	$K_\psi := \frac{8 \cdot G \cdot (ro)^3}{3 \cdot (1-v)}$
Torsional	$B_\theta := \frac{I_\theta}{\rho \cdot (ro)^5}$	$C_\theta := \frac{4 \cdot \sqrt{B_\theta}}{1-2 \cdot B_\theta} \cdot \sqrt{\rho \cdot G}$	$D_\theta := \frac{0.5}{1+2 \cdot B_\theta}$	$K_\theta := \frac{16 \cdot G \cdot (ro)^3}{3}$

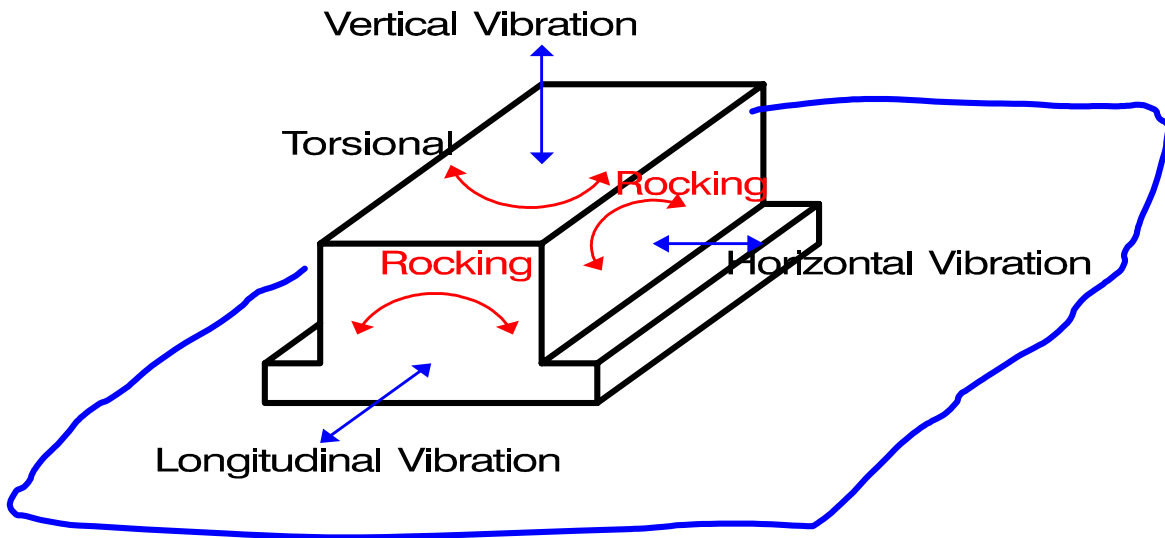

Figure 6
Modes of Vibration

b) Specify the type of exciting force. For a constant amplitude exciting force the load is expressed by:

$$F = F_0 \sin(\omega t) \quad \text{or} \quad M = M_0 \sin(\omega t)$$

where: ω = operating frequency (rad/sec) = $2\pi f$

f = operating frequency (cycle/sec)

F_0 or M_0 = amplitude of exciting force or moment
(constant)

F or M = exciting force or moment

t = time

The exciting force F or moment M may depend on the frequency, ω , and the eccentric mass. In this case:

$$F_0 = m_e e \omega^2 \quad \text{or} \quad F_0 = m_e e \omega^2 L$$

where: m_e = eccentric mass

e = eccentric radius from center of rotation to center of gravity

L = moment arm

c) Compute the undamped natural frequency, f_n , in cycles/second or ω_n in rad/second.

$$f_n = (1/2\pi)(k/m)^{1/2} \quad \text{or} \quad f_n = (1/2\pi)(k/I)^{1/2}$$

$$\omega_n = (k/m)^{1/2} \quad \text{or} \quad (k/m)^{1/2}$$

where: $K = k_z$ for vertical mode, k_x for horizontal mode, k_y for rocking mode and k_q for torsional mode

M = mass of foundation and equipment for vertical and horizontal modes

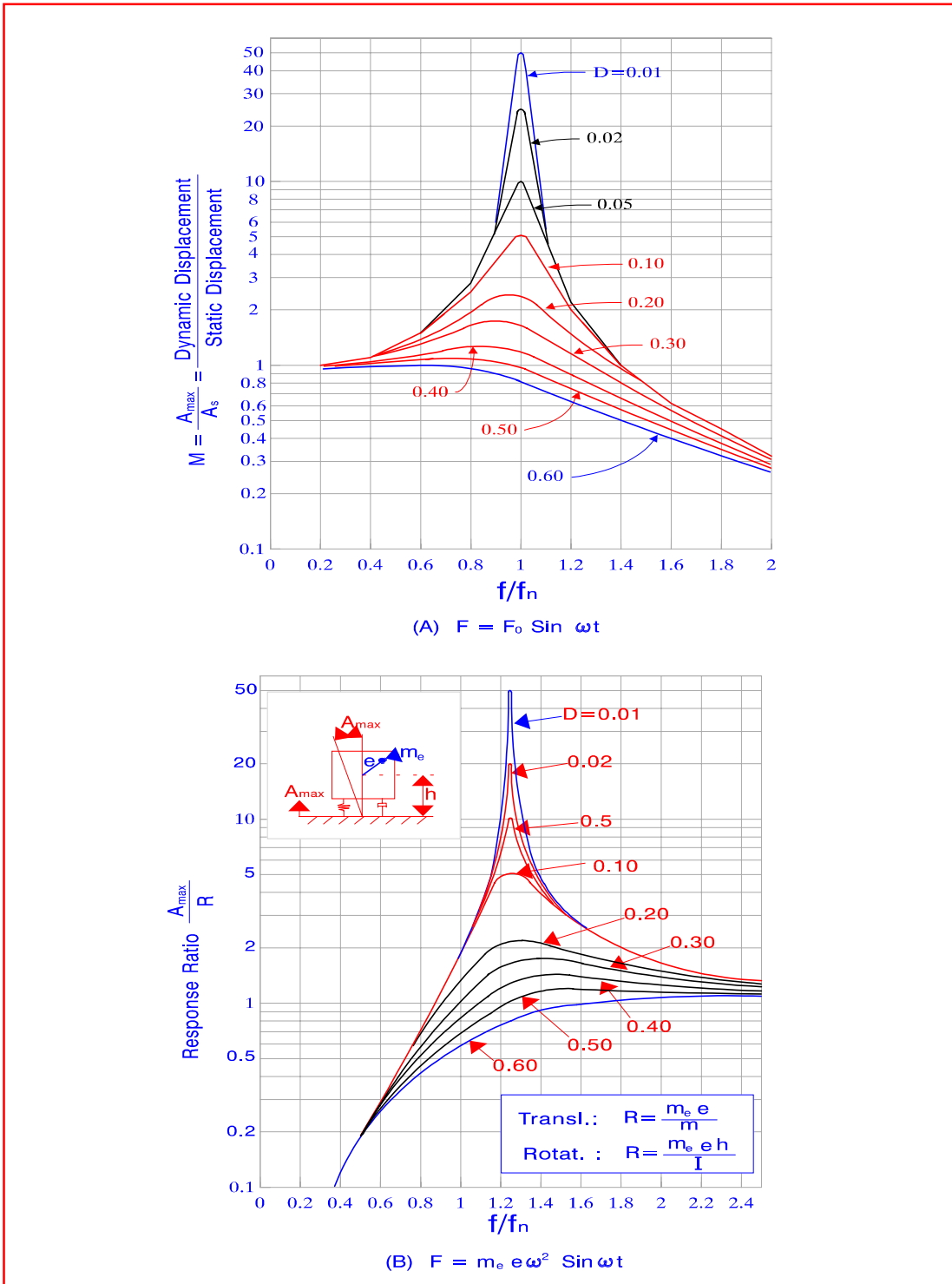
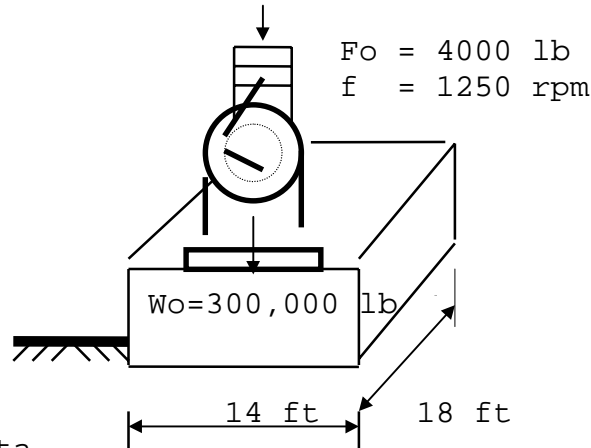

Figure 7
 Response Curves for Single-Degree-of-Freedom
 System With a Viscous Damping

A. VIBRATION IN VERTICAL MODE



Equipment Data

Given a high speed generator with a frequency dependent amplitude
 $F_o := 4000 \cdot \text{lb}$

Weight of vibrating equipment and foundation block $W_o = 300,000 \text{ lb}$

Operating frequency $f = 1250 \text{ rpm}$ $f := 20.83 \cdot \text{sec}^{-1} \text{ cycles/sec}$;

$\omega := f \cdot 2 \cdot \pi$ $\omega = 130.879 \cdot \text{sec}^{-1} \text{ rad/sec}$;

Dimension: $B := 18 \cdot \text{ft}$ $L := 14 \cdot \text{ft}$

Soil Properties

Total unit weight $\gamma_t := 120 \cdot \frac{\text{lb}}{\text{ft}^3}$

Poisson's ratio $\nu := 0.35$;

Shear Modulus $G := 6700 \cdot \frac{\text{lb}}{\text{in}^2}$

Equivalent Radius

$$r_0 := \sqrt{\frac{B \cdot L}{\pi}} \quad r_0 = 8.956$$

Spring Constant

$$K_z := \frac{4 \cdot G \cdot r_0}{1 - \nu} \quad K_z = 5.318$$

Mass Ratio

$$\rho := \frac{\gamma_t}{32.2 \cdot \frac{\text{ft}}{\text{sec}^2}}$$

$$m := \frac{W_o}{32.2 \cdot \frac{\text{ft}}{\text{sec}^2}}$$

$$B_z := \frac{(1 - \nu) \cdot m}{4 \cdot \rho \cdot r_0^3}$$

$$\rho = 3.727$$

$$m = 9.317$$

$$B_z = 0.565$$

Damping Ratio

$$D_z := \frac{0.425}{\sqrt{B_z}}$$

$$D_z = 0.565$$

Static Amplitude

$$A_s := \frac{F_o}{K_z}$$

$$A_s = 9.027 \cdot 10^{-4} \cdot \text{in}$$

Natural Frequency

$$\omega_n := \sqrt{\frac{K_z}{m}}$$

$$\omega_n = 75.548 \text{ sec}^{-1} \text{ rad/sec}$$

Dynamic Amplitude

$$\frac{\omega}{\omega_n} = 1.732$$

Then from Figure 7 (B) and for $D = 0.565$ $M := 1.1$

$$A_{\text{max}} := A_s \cdot M$$

$$A_{\text{max}} = 9.929 \cdot 10^{-4} \cdot \text{in} \text{ Maximum dynamic amplitude}$$

Figure 8

Example Calculation of Vertical, Horizontal, and Rocking Motions

B. EXAMPLE CALCULATION FOR HORIZONTAL TRANSLATION AND ROCKING

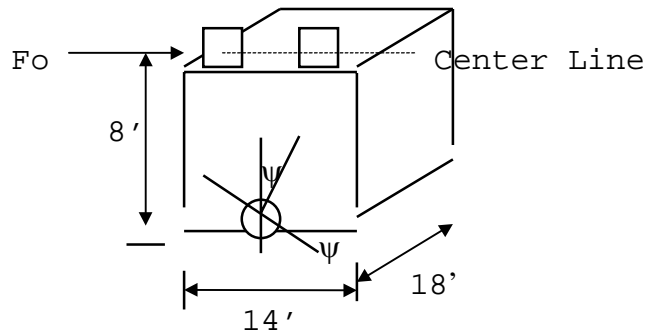

Equipment Data

Assume constant amplitude $F_o := 300\text{-lb}$ Dimensions $B := 18\text{-ft}$ $L := 14\text{-ft}$
 Weight of foundation and machinery $W := 400000\text{-lb}$
 Mass Moment of Inertia around axis of rotation $I_\psi := 400000\text{-lb}\cdot\text{ft}\cdot\text{sec}^2$
 Operating Frequency $f = 350\text{ rpm}$ $f := 5.8\text{-sec}^{-1}$ cycles/sec $\omega := f\cdot 2\cdot\pi$
 $\omega = 36.442\text{ rad/sec}$

Soil Properties

Total Unit Weight $\gamma_t := 120\cdot\frac{\text{lb}}{\text{ft}^3}$ Poisson's Ratio $\nu := 0.35$
 Shear Modulus $G := 6700\cdot\frac{\text{lb}}{\text{in}^2}$

HORIZONTAL TRANSLATION ONLY

Equivalent Radius

$$r_0 := \sqrt{\frac{B\cdot L}{\pi}}$$

$$r_0 = 8.956$$

Mass Ratio

$$m := \frac{400000\text{-lb}}{32.2\cdot\frac{\text{ft}}{\text{sec}^2}}$$

$$m = 1.242$$

$$\rho := \frac{120\cdot\frac{\text{lb}}{\text{ft}^3}}{32.2\cdot\frac{\text{ft}}{\text{sec}^2}}$$

$$\rho = 3.727$$

Spring Constant

$$K_x := \frac{32\cdot(1-\nu)\cdot G\cdot r_0}{7-8\cdot\nu}$$

$$K_x = 4.279$$

$$B_x := \frac{7-8\cdot\nu}{32\cdot(1-\nu)\cdot\rho\cdot r_0^3}$$

$$B_x = 0.937$$

Damping Ratio

$$D_x := \frac{0.288}{\sqrt{B_x}}$$

$$D_x = 0.298$$

Static Displacement

$$A_s := \frac{F_o}{K_x}$$

$$A_s = 8.413$$

Natural Frequency

$$\omega_n := \sqrt{\frac{K_x}{m}}$$

$$\omega_n = 58.693\text{ rad/sec}$$

Figure 8 (Continued)

Example Calculation of Vertical, Horizontal, and Rocking Motions

Dynamic Amplitude

$$\frac{\omega}{\omega_n} = 0.621$$

From Figure 7 (A), $M := 1.4$

$$A_{max} := A_s \cdot M$$

$$A_{max} = 1.178 \quad \text{Maximum Horizontal Movement}$$

ROCKING ALONE

$$r_0 := \left(\frac{B \cdot L^3}{3 \cdot \pi} \right)^{\left(\frac{1}{4} \right)}$$

$$r_0 = 8.508$$

$$B_\psi := \frac{3 \cdot (1 - \nu)}{8} \cdot \frac{I_\psi}{\rho \cdot r_0^5}$$

$$B_\psi = 0.454$$

$$F_0 := (300 \text{ lb}) \cdot (8 \text{ ft})$$

$$F_0 = 2.88$$

Spring Constant

$$K_\psi := \frac{8 \cdot G r_0^3}{3 \cdot (1 - \nu)}$$

$$K_\psi = 2.926 \quad \text{lb} \cdot \text{in} / \text{rad}$$

Damping Ratio

$$D_\psi := \frac{0.15}{(1 + B_\psi) \cdot \sqrt{B_\psi}}$$

$$D_\psi = 0.153$$

Natural Frequency

$$\omega_n := \sqrt{\frac{K_\psi}{I_\psi}}$$

$$\omega_n = 78.07$$

Static Rotation

$$A_\psi := \frac{F_0}{K_\psi}$$

$$A_\psi = 9.844 \quad \text{radians}$$

Dynamic Amplitude

$\omega := 131 \cdot \text{sec}^{-1}$ From Figure 7 (A), $M := 0.4$

$$\frac{\omega}{\omega_n} = 1.678 \quad \text{Maximum Rocking Movement} \quad \text{Horizontal Motion At Machine Centerline}$$

$$A_{\psi \cdot \max} := A_\psi \cdot M$$

$$A_{\psi \cdot \max} = 3.938$$

$$\text{Movement} := A_{\psi \cdot \max} \cdot (8 \cdot \text{ft})$$

$$\text{Movement} = 3.15 \quad \text{radians}$$

NOTE:

Above analysis is approximate since horizontal and rocking modes are coupled.

A lower bound estimate of first mode frequency may be calculated based on natural frequency ω_n for rocking mode alone, and horizontal translation mode alone.

Figure 8 (Continued)
Example Calculation of Vertical, Horizontal, and Rocking Motion

1.4.1.5 Dynamic Soil Properties. Guidance on dynamic soil properties and their determination is given in Sections 2 and 3.

There are several interrelated criteria for design of foundations for machinery. The most fundamental is that the vibratory movement be held to a level below that which could damage the machinery or cause settlement of loose soils. In many cases there are too many unknowns to solve this problem. The other criterion is to proportion the foundation such that resonance with the operating frequency of the machine is avoided. For high frequency machines (say over 1000 rpm) it is common to "low tune" the foundation, so that the foundation frequency is less than half the operating frequency. For low frequency machines (say under 300 rpm) it is common to "high tune" the foundation, so that the fundamental frequency is at least twice the operating frequency.

1.4.2 Design to Avoid Resonance. Settlements from vibratory loads and displacements of the machinery itself in all directions are accentuated if imposed vibrations are resonant with the natural frequency of the foundation soil system. Both the amplitude of foundation motion and the unbalanced exciting force are increased at resonance. Compact cohesionless soils will be densified to some degree with accompanying settlement. Avoidance of resonance is particularly important in cohesionless materials, but should be considered for all soils. To avoid resonance, the following guidelines may be considered for initial design to be verified by the previous methods.

1.4.2.1 High-Speed Machinery. For machinery with operating speeds exceeding about 1000 rpm, provide a foundation with natural frequency no higher than one-half of the operating value, as follows:

a) Decrease natural frequency by increasing the weight of foundation block, analyze vibrations in accordance with the methods discussed.

b) During starting and stopping the machine will operate briefly at the resonant frequency of the foundation. Compute probable amplitudes at both resonant and operating

frequencies, and compare them with allowable values to determine if the foundation arrangement must be altered.

1.4.2.2 Low-Speed Machinery. For machinery operating at a speed less than about 300 rpm, provide a foundation with a natural frequency at least twice the operating speed, by one of the following:

a) For spread foundations, increase the natural frequency by increasing base area or reducing total static weight.

b) Increase modulus or shear rigidity of the foundation soil by compaction or other means of stabilization. Refer to NAVFAC DM-7.02, Chapter 2.

c) Consider the use of piles to provide the required foundation stiffness. See example in Figure 9.

1.4.2.3 Coupled Vibrations. Vibrations are coupled when their modes are not independent but influence one another. A mode of vibration is a characteristic pattern assumed by the system in which the motion of each particle is simple harmonic with the same frequency. In most practical problems, the vertical and torsional modes can be assumed to be uncoupled (i.e., independent of each other). However, coupling effects between the horizontal and rocking modes can be significant depending on the distance between the center of gravity of the footing and the base of the footing. The analysis for this case is complicated and time consuming.

A lower bound estimate of the first mode, f_o , of coupled rocking and horizontal vibration can be obtained from:

$$1/f_o^2 = 1/f_x^2 + 1/f_y^2$$

f_x and f_y are the undamped natural frequencies in the horizontal and rocking modes respectively. For further guidance refer to Vibrations of Soils and Foundations, by Richart, et al., 1970, and Coupled Horizontal and Rocking Vibrations of Embedded Footings, by Beredugo and Novak, 1972.

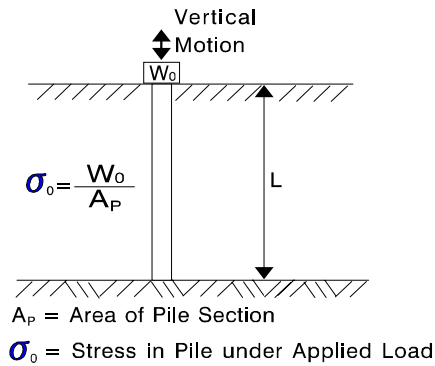
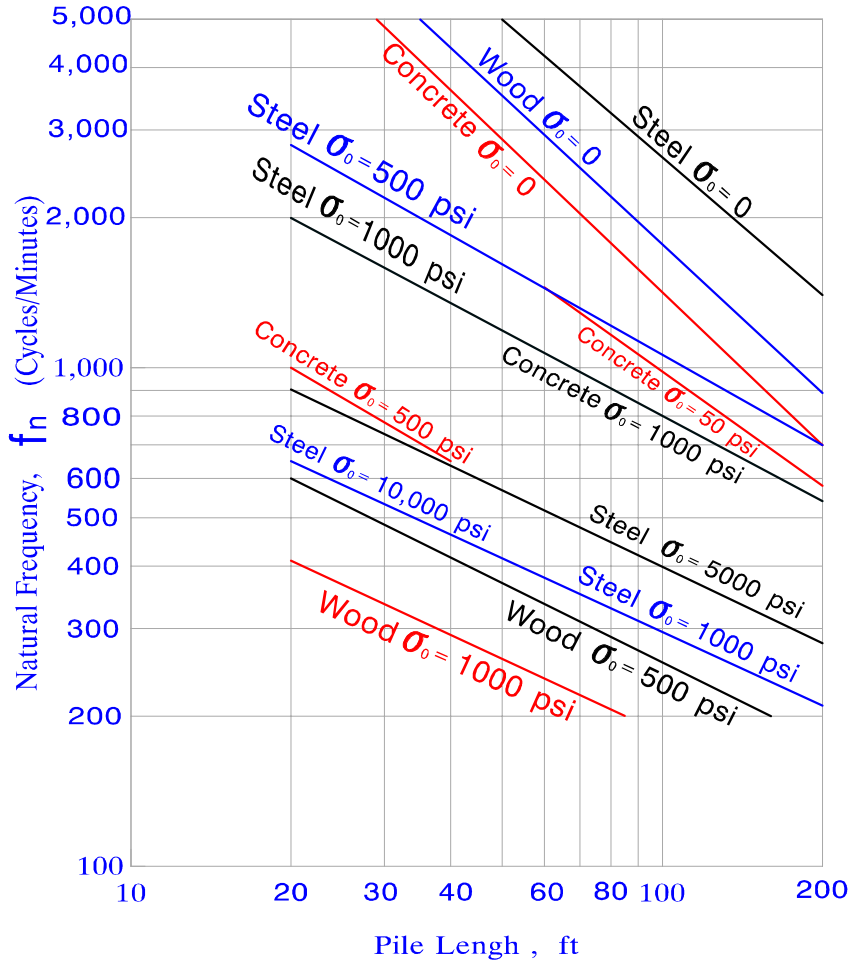

Example Design to Avoid Resonance:

For machinery operating at a low-speed (less than 300 rpm), provide a foundation with a natural frequency at least twice the operating speed.

This example considers the use of piles to provide the required foundation stiffness.

Figure 9
 Natural Undamped Frequency of Point Bearing Piles on Rigid Rock

1.4.2.4 Effect of Embedment. Stiffness and damping are generally increased with embedment. However, analytical results (especially for damping) are sensitive to the conditions of the backfill (properties, contact with the footings, etc.). For footings embedded in a uniform soil with a Poisson's ratio of 0.4, the modified stiffness parameters are approximated as follows (Stiffness and Damping Coefficients of Foundations, Dynamic Response of Pile Foundations, Analytical Aspects, Roesset, 1980):

$$(k_z)_d \approx k_z[1 + 0.4(d/r_o)]$$

$$(k_x)_d \approx k_x[1 + 0.8(d/r_o)]$$

$$(k_y)_d \approx k_y[1 + 0.6(d/r_o) + 0.3(d/r_o)^3]$$

$$(k_q)_d \approx k_q[1 + 2.4(d/r_o)]$$

$(k_z)_d$, $(k_x)_d$, $(k_y)_d$, and $(k_q)_d$, are spring constants for depth of embedment d .

Increases in embedment d will cause an increase in damping, but the increase in damping is believed to be sensitive to the condition of backfill. For footings embedded in a uniform soil, the approximate modifications for damping coefficient C (in Figure 6) are:

$$(C_z)_d \approx C_z[1 + 1.2(d/r_o)]$$

$$(C_\theta)_d \approx r_o^4(\rho G)^{1/2}[0.7 + 5.4(d/r_o)]$$

where $(C_z)_d$ and $(C_\theta)_d$ are the damping coefficients in vertical and torsion modes for embedments d .

1.4.2.5 Proximity of a Rigid Layer. A relatively thin layer of soil over rigid bedrock may cause serious magnification of all amplitudes of vibration. In general, the spring constants increase with decreasing thickness of soil while damping coefficients decrease sharply for the vertical modes and to a lesser extent for horizontal and rocking modes. Use the

following approximate relation for adjusting stiffness and damping to account for presence of a rigid layer (Dynamic Stiffness of Circular Foundations, Kausel and Roesset, 1975):

$$(K_z)_L = K_z (1 + r_o/H), \quad r_o/H < 1/2$$

$$(K_x)_L = K_x [1 + 1/2(r_o/H)], \quad r_o/H < 1/2$$

$$(K_y)_L = K_y [1 + 1/6(r_o/H)], \quad r_o/H < 1/2$$

where $(K_z)_L$, $(K_x)_L$, $(K_y)_L$ are stiffness parameters in case a rigid layer exists at depth H below a footing with radius r_o .

The damping ratio parameter D is reduced by the presence of a rigid layer at depth H. The modified damping coefficient (D_z) is 1.0 D_z for $H/r_o = \infty$, and approximately 0.31 D_z , 0.16 D_z , 0.09 D_z , and 0.044 D_z for $H/r_o = 4, 3, 2$ and 1 respectively (Soil Structural Interaction, Richart, 1977).

1.4.2.6 Vibration for Pile Supported Machine Foundation. For piles bearing on rigid rock with negligible side friction, use Figure 9 for establishing the natural frequency of the pile soil system. Tip deflection and lateral stiffness can have a significant effect on natural frequency of the pile soil system (Response of Piles to Vibratory Loads, Owies, 1977). Solution for simple but practical cases for stiffness and damping coefficients are presented by Impedance Function of Piles in Layered Media, Novak and Aboul-Ella, 1978. Alternatively, and for important installations, such coefficients can be evaluated from field pile load tests.

1.4.3 Bearing Capacity and Settlements. Vibration tends to densify loose nonplastic soils, causing settlement. The greatest effect occurs in loose, coarse-grained sands and gravels. These materials must be stabilized by compaction or other means to support spread foundations for vibrating equipment; refer to methods of NAVFAC DM-7.02, Chapter 2. Shock or vibrations near a foundation on loose, saturated nonplastic silt, or silty fine sands, may produce a quick condition and partial loss of bearing capacity. In these cases, bearing

intensities should be less than those normally used for static loads. For severe vibration conditions, reduce the bearing pressures to one-half allowable static values.

In most applications, a relative density of 70 percent to 75 percent in the foundation soil is satisfactory to preclude significant compaction settlement beneath the vibratory equipment. However, for heavy machinery, higher relative densities may be required. The following procedure may be used to estimate the compaction settlement under operating machinery.

The critical acceleration of machine foundations, $(a)_{crit}$, above which compaction is likely to occur, may be estimated (Dynamics of Bases and Foundation, Barkan, 1962) based on:

$$(a)_{crit} = -\ln[1-(D_r)_0/100]/\beta$$

where: $(a)_{crit}$ = critical acceleration expressed in g's

$(D_r)_0$ = initial (in situ) relative density at zero acceleration expressed in percent.

β = coefficient of vibratory compaction, a parameter depending on moisture content; varies from about 0.8 for dry sand down to 0.2 for low moisture contents (about 5 percent). It increases to a maximum value of about 0.88 at about 18 percent moisture content. Thereafter, it decreases.

When densification occurs as a result of vibrations there will be an increase in relative density ΔD_r , and for a sand layer with a thickness H, the settlement would be ΔH . The strain $\Delta H/H$ can be expressed in terms of ΔD_r as:

$$\Delta H/H = 0.0025(\Delta D_r\%/100)\gamma_{do}$$

where: γ_{do} = the initial dry density of the sand layer (lb/cu. ft)

The above equation is based on the range of maximum and minimum dry densities for sands (Burmister, 1962). The change in relative density ΔD_r due to vibration is defined as:

$$\Delta D_r = (D_r)_f - (D_r)_o$$

where: $(D_r)_o$ = initial in-situ relative density which may be estimated from the standard penetration resistance (refer to NAVFAC DM-7.01, Chapter 2)

$(D_r)_f$ = final relative density, which may be conservatively estimated based on:

$$(D_r)_f = 100\{1 - \exp[(-\beta)[(a_i)_{crit} + a_i]]\} \quad \text{for } a_i > (a_i)_{crit}$$

$$(D_r)_f = (D_r)_o \quad \text{for } a_i < (a_i)_{crit}$$

where: a_i = acceleration expressed in g's

The above equation is based on the work reported in Barkan, 1962. In the above equation $(a_i)_{crit}$ and (a_i) are the critical acceleration and acceleration produced by equipment in each layer i . The acceleration a_i produced by equipment may be approximated using the following:

$$a_i = a_o(r_o/d)^{1/2} \quad \text{for } d > r_o$$

$$a_i = a_o \quad \text{for } d < r_o$$

where: a_o = acceleration of vibration in g's at foundation level

d = distance from base of foundation to mid point of soil layer

r_o = equivalent radius of foundation

If maximum displacement, A_{max} , and frequency of vibration, ω rad/sec, are known at base of foundation then:

$$a_o = \omega^2 A_{max}$$

An example illustrating the use of the above principles is shown in Figure 10.

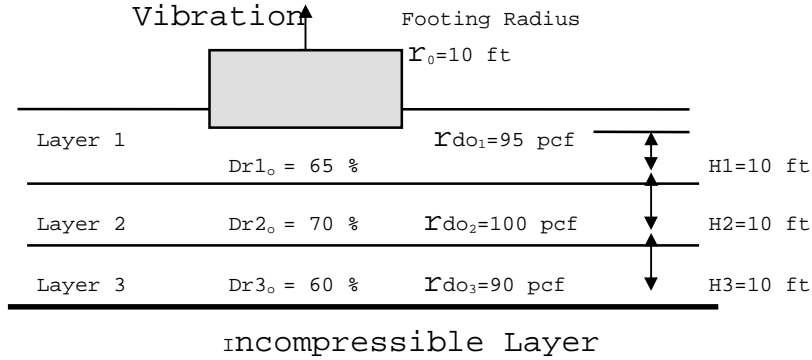

GIVEN: Soil profile as shown:

Footing with radius $r_o := 10\text{ft}$ subjected to a vibratory load causing a peak dynamic displacement $A_{\max} := 0.007 \cdot \text{in}$

Operating frequency $f := 2500\text{min}^{-1}$ (rev/min). Moisture content of soil is 16%. Use $\beta := 0.88$

$$\omega := f \cdot 2\pi \quad \omega = 26 \text{ (rad/sec)} \quad a_o := \frac{\omega^2 \cdot A_{\max}}{32.2 \frac{\text{ft}}{\text{sec}^2}} \quad a_o = 1.2 \text{ g}$$

LAYER 1

Depth to mid layer $d := 5\text{-ft}$ $d < r_o$ Therefore use $a_i := a_o$

$$\text{Critical Acceleration } a_{\text{crit}} := \frac{-\ln\left(1 - \frac{Dr1_o}{100}\right)}{\beta} \quad a_{\text{crit}} = 1.1 \text{ g} \quad a_i > a_{\text{crit}}$$

$$D_{\text{rf}} := 100 \left[1 - \exp\left[(-\beta) \cdot (a_{\text{crit}} + a_i)\right]\right] \quad \Delta Dr := D_{\text{rf}} - Dr1_o \quad \Delta H := \left(0.0025 \frac{\text{ft}^3}{\text{lb}} \cdot \frac{\Delta Dr}{100} \cdot \gamma_{\text{do1}}\right) \cdot H_1$$

$$D_{\text{rf}} = 88.2\% \quad \Delta Dr = 23.2\% \quad \Delta H = 6.63$$

LAYER 2

$d_{\text{midlayer}} := 15\text{-ft}$

$$a_i := a_o \cdot \sqrt{\frac{r_o}{d_{\text{midlayer}}}} \quad a_{\text{crit}} := \frac{-\ln\left(1 - \frac{Dr2_o}{100}\right)}{\beta}$$

$$a_i = 0.785 \text{ g} \quad a_{\text{crit}} = 1.368 \text{ g}$$

$a_i < a_{\text{crit}}$

$$D_{\text{rf}} := Dr2_o$$

No significant compaction settlement is likely.

LAYER 3

$d := 25\text{-ft}$

$$a_i := a_o \cdot \sqrt{\frac{r_o}{d}} \quad a_{\text{crit}} := \frac{-\ln\left(1 - \frac{Dr3_o}{100}\right)}{\beta}$$

$$a_i = 0.785 \text{ g} \quad a_{\text{crit}} = 1.368 \text{ g}$$

$a_i < a_{\text{crit}}$

No significant compaction settlement is likely.

Anticipated Compaction Settlement = 6.6 in. Increase relative density of top layer to 70 percent or greater.

Figure 10
Example Calculation for Vibration Induced Compaction Settlement Under Operating Machinery

1.4.4 Vibration Transmission, Isolation, and Monitoring.

For Vibration transmission, isolation, and monitoring the following guidance is provided.

1.4.4.1 Vibration Transmission. Transmission of vibrations from outside a structure or from machinery within the structure may be annoying to occupants and damaging to the structure. Vibration transmission may also interfere with the operation of sensitive instruments. See Figure 11 for the effects of vibration amplitude and frequency. Tolerable vibration amplitude decreases as frequency increases. For approximate estimates of vibration amplitude transmitted away from the source use the following relationship:

$$A_2 = A_1 (r_1/r_2)^{1/2} e^{-\alpha(r_2-r_1)}$$

Where: A_1 = computed or measured amplitude at distance r_1 from vibration source.

A_2 = amplitudes at distance r_2 , $r_2 > r_1$

α = coefficient of attenuation depending on soil properties and frequency. Use Table 1.

Table 1
Attenuation Coefficient for Earth Materials

Materials	α^* (1/ft) @50 Hertz**
Sand Loose, fine	0.06
Dense, fine	0.02
Clay Silty (loess)	0.06
Dense, dry	0.003
Rock Weathered volcanic	0.002
Competent marble	0.00004

* α is a function of frequency.

For other frequencies, f, compute $\alpha_f = (f/50)\alpha_{50}$

** Hertz - cycles per second.

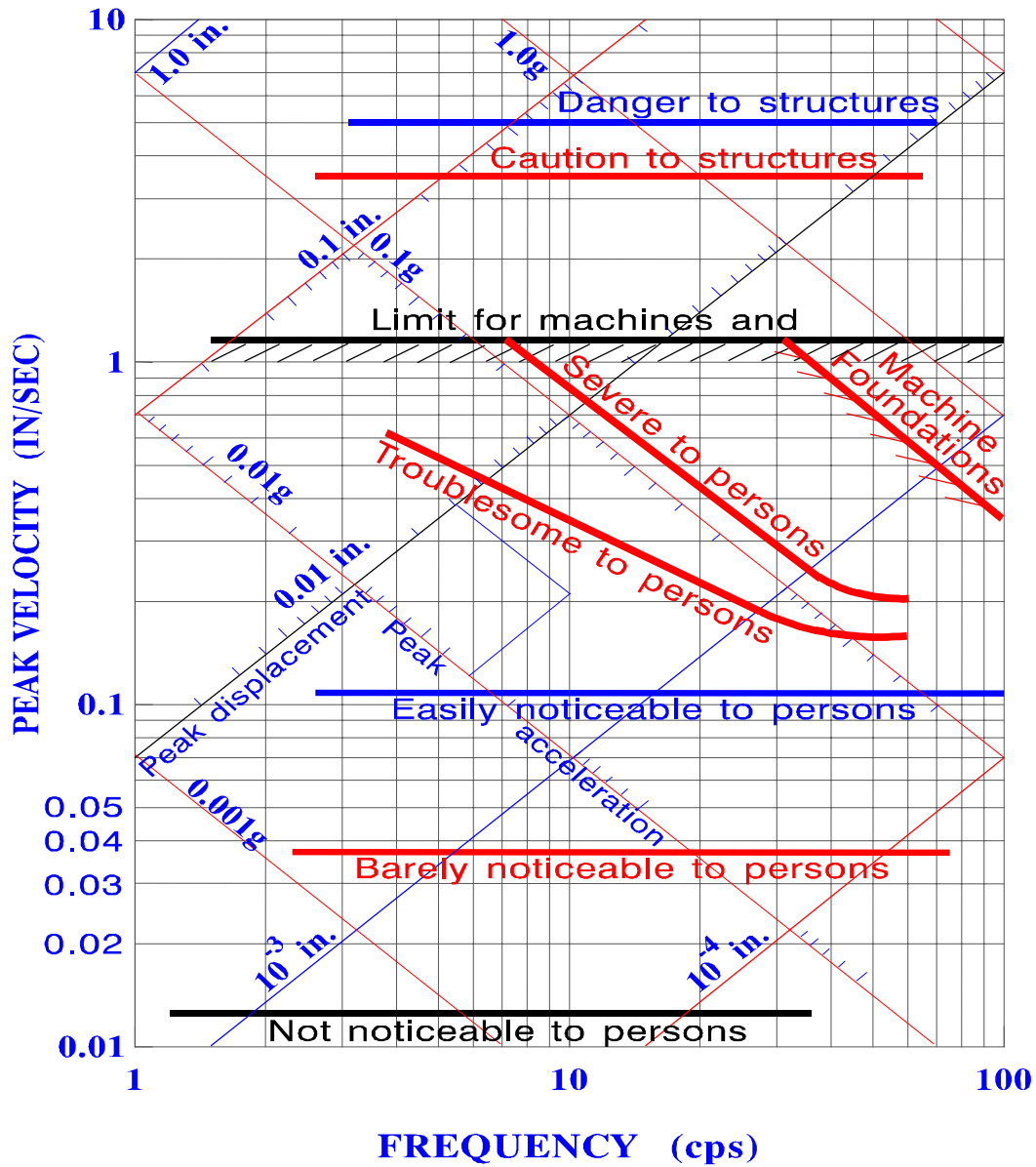

Given Velocity = 0.2 inch/sec.
 Frequency = 10 cps
 Then from Graph, Displacement = 0.003 inches
 Acceleration = 0.03g
 Motion is easy noticeable or troublesome to persons

Figure 11
 Allowable Amplitude of Vertical Vibrations

1.4.4.2 Vibration and Shock Isolation. For vibration and shock isolation see the following methods.

a) General Methods. For general methods of isolating vibrating equipment or insulating a structure from vibration transmission, refer to paragraph 2.7. These methods include physical separation of the vibrating unit from the structure, or interposition of an isolator between the vibrating equipment and foundation or between the structure foundation and an outside vibration source. Vibration isolating mediums include resilient materials such as metal springs, or pads of rubber, or cork and felt in combination.

b) Other Methods. Additional methods available include the installation of open or slurry-filled trenches, sheet pile walls, or concrete walls. These techniques have been applied with mixed results. Analytical results suggest that for trenches to be effective, the depth of the trench should be $0.67L$ or larger, where L is wave length for a Rayleigh wave and is approximately equal to V_s/ω ; when ω is the angular velocity of vibration in radian/sec, V_s is the shear wave velocity of the soil. Concrete walls may have isolating efficiency depending on the thickness, length, and rigidity (Isolation of Vibrations by Concrete Core Walls, Haupt, 1977).

1.4.4.3 Vibration Monitoring. Control of ground vibrations is necessary to ensure that the acceptable levels of amplitudes for structural safety are not exceeded. The sources of vibrations that may affect nearby structures are blasting, pile driving, or machinery. Acceptable vibration amplitudes are usually selected based on conditions of the structure, sensitivity of equipment within the structure, or human tolerance. Refer to NAVFAC DM-7.02, Chapter 1 for selection of blasting criteria in terms of peak particle velocity to avoid damage to structures.

For structures which may be affected by nearby sources of vibrations (e.g., blasting, pile driving, etc.) seismographs are usually installed at one or more floors to monitor the effect and maintain records if site vibration limits are exceeded. A seismograph usually consists of one or more transducers which are either embedded, attached, or resting on the vibrating structure, element, or soil and connected by a cable to the recording unit. The recording medium may be an oscilloscope or a magnetic tape. Most modern seismographs use digital technology, which provides records that can be processed readily. The actual details of installation depend on the type of equipment, nature of vibration surface, and expected amplitudes of motion.

1.5 DYNAMIC AND VIBRATORY COMPACTION

1.5.1 Soil Densification. Dynamic and vibratory methods are often very effective in densifying soil to increase strength, reduce settlements, or lessen the potential for liquefaction. There are several different methods. Some are proprietary, and most contractors prefer to use one method because they have experience with it and have invested in the equipment. Each method works best in certain soils and poorly in others. Therefore, no one method can be used in all circumstances.

1.5.2 Vibro-Densification. Stabilization by densifying in-place soil with vibro-densification is used primarily for granular soils where excess pore water may drain rapidly. It is effective when the relative density is less than about 70 percent. At higher densities, additional compaction may not be needed and may even be difficult to achieve. Through proper treatment, the density of in-place soil can be increased considerably to a sufficient depth so that most types of structures can be supported safely without undergoing unexpected settlements. Figure 12 shows the range of grain size distribution for soils amendable to vibro densification. Effectiveness is greatly reduced in partly saturated soils in which 20 percent or more of the material passes a No. 200 sieve.

1.5.3 Dynamic Compaction. The use of high-energy impact to densify loose granular soils in situ has increased over the years. This soil improvement technique, commonly known as dynamic compaction has become a well established method for treating loose granular soils due to its simplicity and cost effectiveness.

A heavy weight (10 to 40 tons or more) is dropped from a height of 50 to 130 feet at points spaced 15 to 30 feet apart over the area to be densified to apply a total energy of 2 to 3 blows per square yard. In saturated granular soils the impact energy will cause liquefaction followed by settlement as the water drains. Radial fissures that form around the impact points will facilitate drainage. The method may be used to treat soils both above and below the water table. In granular soils the effectiveness is controlled mainly by the energy per drop. Use the following relationship to estimate effective depth of influence on compaction:

$$D = 1/2(Wh)$$

where: D = depth of influence, in feet
 W = falling weight in tons
 h = height of drop in feet

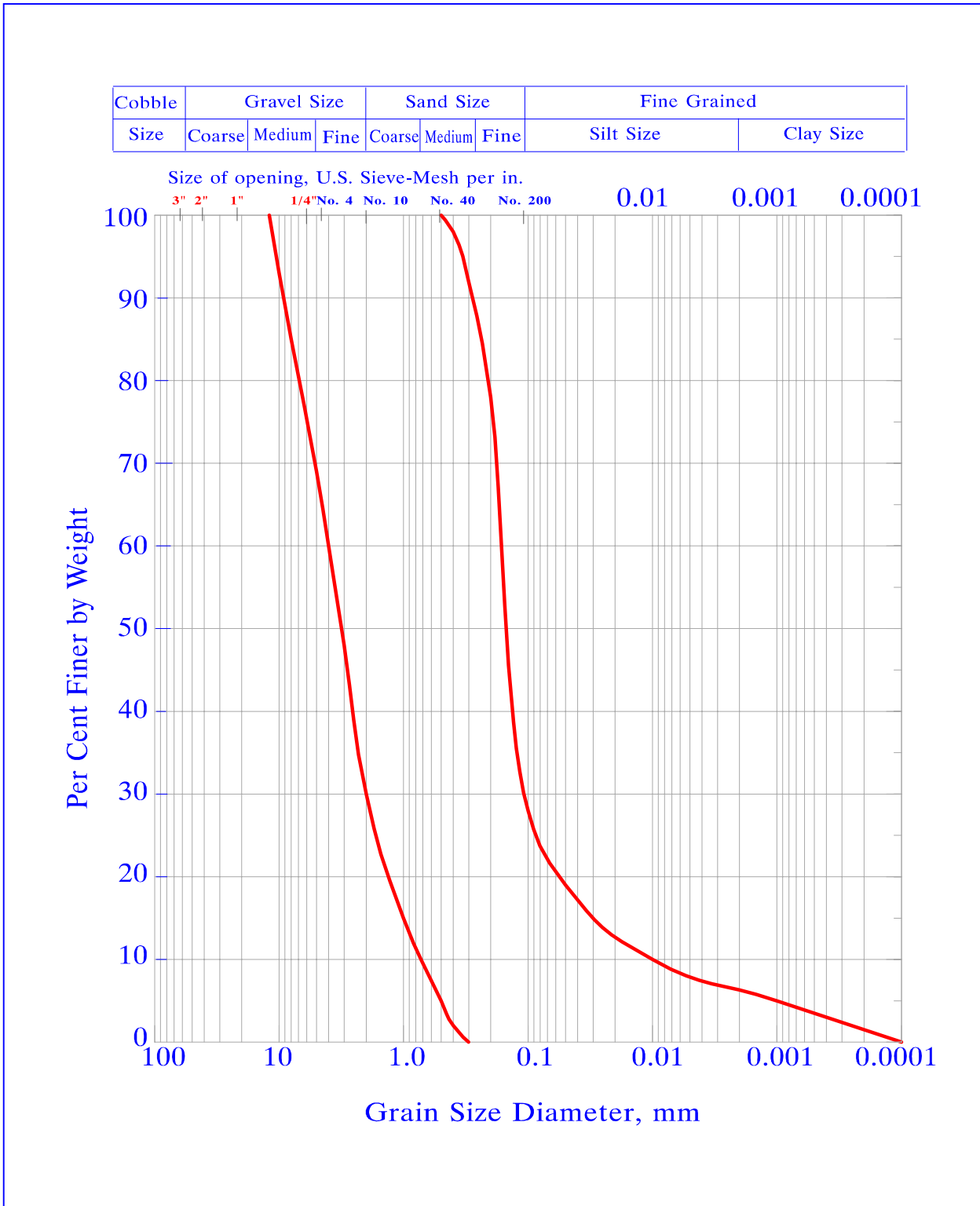

Figure 12
 Grain Size Ranges Considered for Vibro-Densification

Relative densities of 70 to 90 percent can be obtained. Bearing capacity increases of 200 to 400 percent can usually be obtained for sands. A minimum treatment area of 4 to 8 acres is necessary for economical use of this method. Currently this method is considered experimental for saturated clays. Because of the high-amplitude, low-frequency vibrations (1 to 12Hz), it is necessary to maintain minimum distances from adjacent facilities as follows:

Piles or bridge abutment	15 to 20 feet
Liquid storage tanks	30 feet
Reinforced concrete building	50 feet
Dwellings	100 feet
Computers (not isolated)	300 feet

Table 2 summarizes the procedures and applicability of the most commonly used in-place densification methods.

Table 2
Dynamic Compaction

Method	Procedure Used	Application Limitation	Modification of Soil Properties
Dynamic Compaction	Heavy weights (typically 10-40 tons) are dropped repeatedly from height of 50 to 130 ft on points 15 to 30 ft apart. Tamper weight (tons) times the height of fall (ft) should be greater than the layer to be densified. A total energy of 2 to 3 blows per square yard is considered adequate.	Can be used both above and below the ground-water level. In granular soils high energy impact causes partial liquefaction. Generates low frequency vibrations that make this method less desirable in urban areas and near existing structures. Not a proven technique in saturated fine-grained soils.	Relative density may be increased to 70 to 90 percent. Relatively uniform increase in density throughout effective depth. Maximum depth of improvement about 90 feet.

1.5.4 Applications of Vibroflotation. Vibroflotation is used to densify granular soils. A crane-suspended cylindrical penetrator about 16 inches in diameter and 6 feet long, called a vibroflot, is attached to an adapter section containing lead wires and hoses. Electrically driven vibrators have RPM's in the order of 1800 to 3000. Hydraulically driven vibrators have variable frequencies. Total weight is generally about two tons. Power ranges between 30 and 134 Hp are available with corresponding centrifugal force ranging from 10 to 31 tons with peak-to-peak amplitudes ranging from 3 to 10 inches.

To sink the vibroflot to the desired treatment depth, a water jet at the tip is opened and acts in conjunction with the vibrations so that a hole can be advanced at a rate of 18 inches per minute. The bottom jet is then closed and the vibroflot is withdrawn at a rate of about one ft/min for 30 Hp vibroflots and approximately twice that rate for vibroflots over 100 Hp. Concurrently, a sand or gravel backfill is dumped in from the ground surface and densified. Backfill consumption is at a rate of about 0.5 to 1.5 cubic yards per minute. In partially saturated sands, water jets at the top of the vibroflot can be opened to facilitate liquefaction and densification of the surrounding ground. Most of the compaction takes place within the first 2 to 5 minutes at any elevation.

See Figure 13 for guidance on the relationship between vibration center spacing versus relative density. For guidance on the relationship between spacing and allowable bearing pressure with respect to settlement, refer to Reference 1.5.4. Equilateral grid probe patterns are best for compacting large areas, while square and triangular patterns are used for compacting soils for isolated footings. See Table 3 as a guide for patterns and spacings required for an allowable pressure of 3 tsf under square footings using a 30 Hp unit.

1.5.5 Compaction Grout. Compaction grouting, which is defined as the staged injection of low slump (less than 3 inches) mortar-type grout into soils at high pressures (500 to 600 pounds per square inch), is used to densify loose granular soils. At each grout location a casing is drilled to the bottom of a previously specified soil target zone. Compaction grout is

then pumped into the casing at increments of one lineal foot. When previously determined criteria are met such as volume, pressure, and heave, pumping will be terminated and the casing will be withdrawn. The casing will be continuously withdrawn by one foot when it meets previously determined criteria until the hole is filled.

To detect when the grout criteria have been met it is useful to have a strip chart recorder attached to the grout line. A strip chart recorder produces a pressure versus time plot. Such a record, coupled with a known volume of grout delivered per pump piston stroke, can serve as a flow meter. In addition, the pressures versus time plot indicates a pattern in the development of the grout pressures.

Table 3
Examples of Vibroflotation Patterns and Spacings for Footings

Desired Allowable Bearing Pressure = 3 TSF			
Square Footing (size - ft)	Number of Vibroflotation Points	C-C Spacing (feet)	Pattern
<4	1	---	---
4.5 - 5.5	2	6	Line
6 - 7	3	7.5	Triangle
7.5 - 9.5	4	6	Square
10 - 11.5	5	7.5	Square plus one @ center

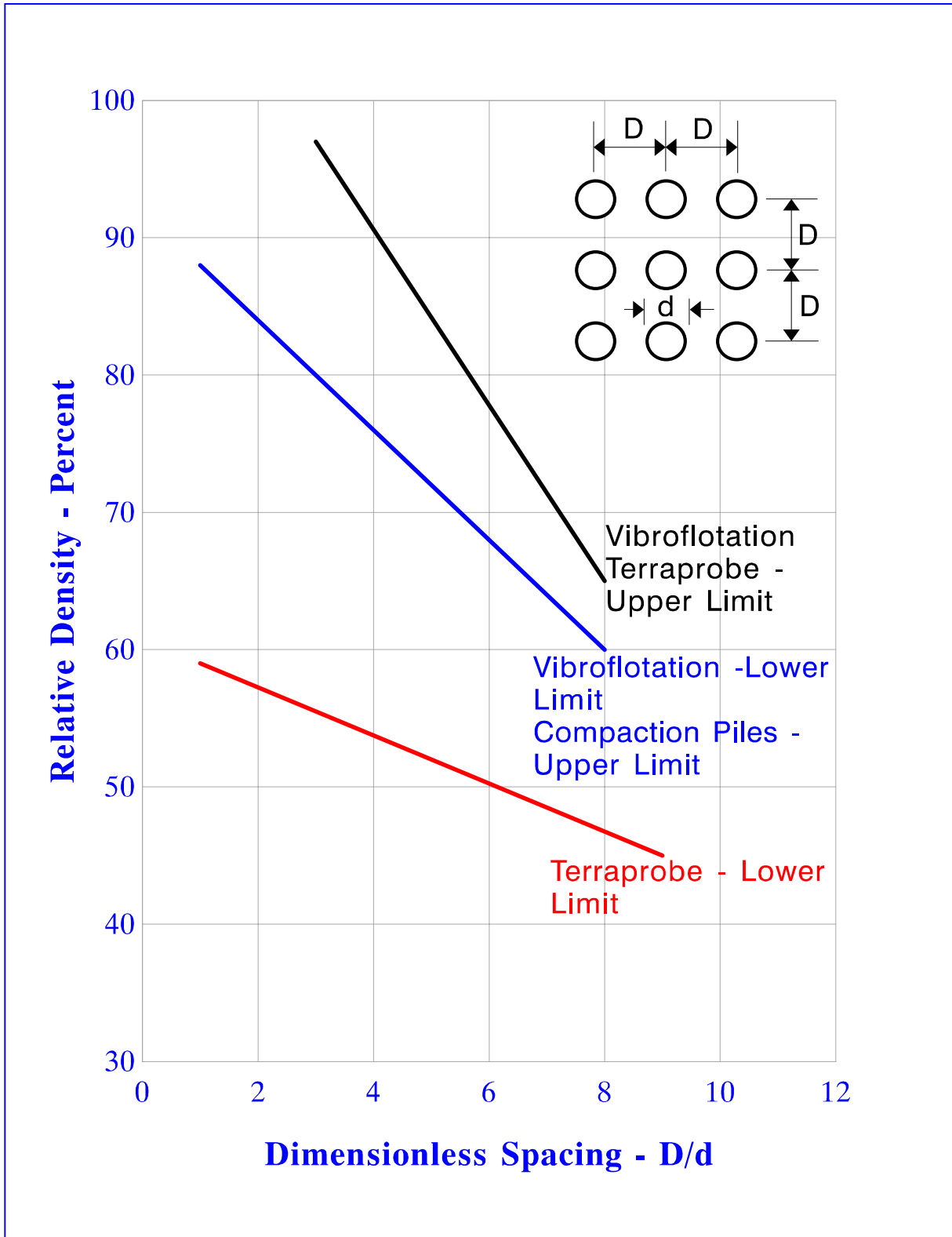

Figure 13
Relative Density vs. Probe Spacing for Soil Densification

Based on evaluation of subsurface data and proposed structure stresses, areas requiring compaction grouting can be identified, and minimum ground improvement criteria can be established. Ground improvement criteria can be determined based on settlement and bearing capacity analyses. A grouting injection point grid and construction sequence can be formulated once the ground improvement criteria are known. Typically, the grouting points are injected from the perimeter of a grid towards the center.

1.5.6 Selecting A Method. There are many combinations and variations of the vibratory compaction and vibro-replacement methods. These have been developed by different organizations using various configurations of equipment and procedures. Each method will work well in some circumstances and poorly in others. In some cases it may be possible to eliminate several techniques on the basis of the soil type and conditions, but there will usually be several candidate methods remaining.

When selecting a method of dynamic or vibratory compaction, the engineer should bear in mind that, in addition to the usual factors of cost and time to complete the work, the success of the jobs will depend on how effective is the chosen method. In many cases this will only become evident when an effective technique is employed at the actual site. In some cases techniques that seemed to be suitable have proven ineffective in practice. The engineer should plan for this contingency. For a large project, a test section may be a wise investment.

1.6 PILE DRIVING RESPONSE

1.6.1 Wave Equation Analysis. The wave equation analysis that models the dynamics of hammer-pile-soil interaction uses computer programs to evaluate the pile driving response. The wave equation analysis is used to evaluate: (1) pile capacity, (2) equipment compatibility, and (3) driving stresses. In a wave equation analysis, the hammer, helmet, and pile are modeled by a series of masses connected by weightless springs. The soil resistances along the embedded portion of the pile and at the pile toe consists of both static and dynamic components. A formulation of the dynamic model, representing hammer-pile-soil system, to solve the wave equation is shown in Figure 14.

The required input data are as follows:

- a) Height of fall for the ram and its weight or a numerical description or energy supplied by the hammer versus time;
- b) Weight of pile cap, capblock, pile segments, driving shoe, and modulus of elasticity of the pile;
- c) Values of capblock and pile-cushion spring constants;
- d) Soil properties: quake (elastic compression of soil), side damping, and point damping;
- e) Estimate of percent of the ultimate load carried by the pile point.

1.6.2 Wave Propagation in Piles. A longitudinal wave propagates along the pile axis when a hammer applies an impact load to a pile. As the ram impact occurs, a force pulse is developed. The amplitude and duration of the force pulse depend on the properties of the hammer-pile-soil system. The force pulse in the pile travels downward toward the pile toe at a constant velocity, which depends on the wave speed of the pile material. When the force pulse reaches the portion of the pile embedded in soil, its amplitude is reduced due to static and

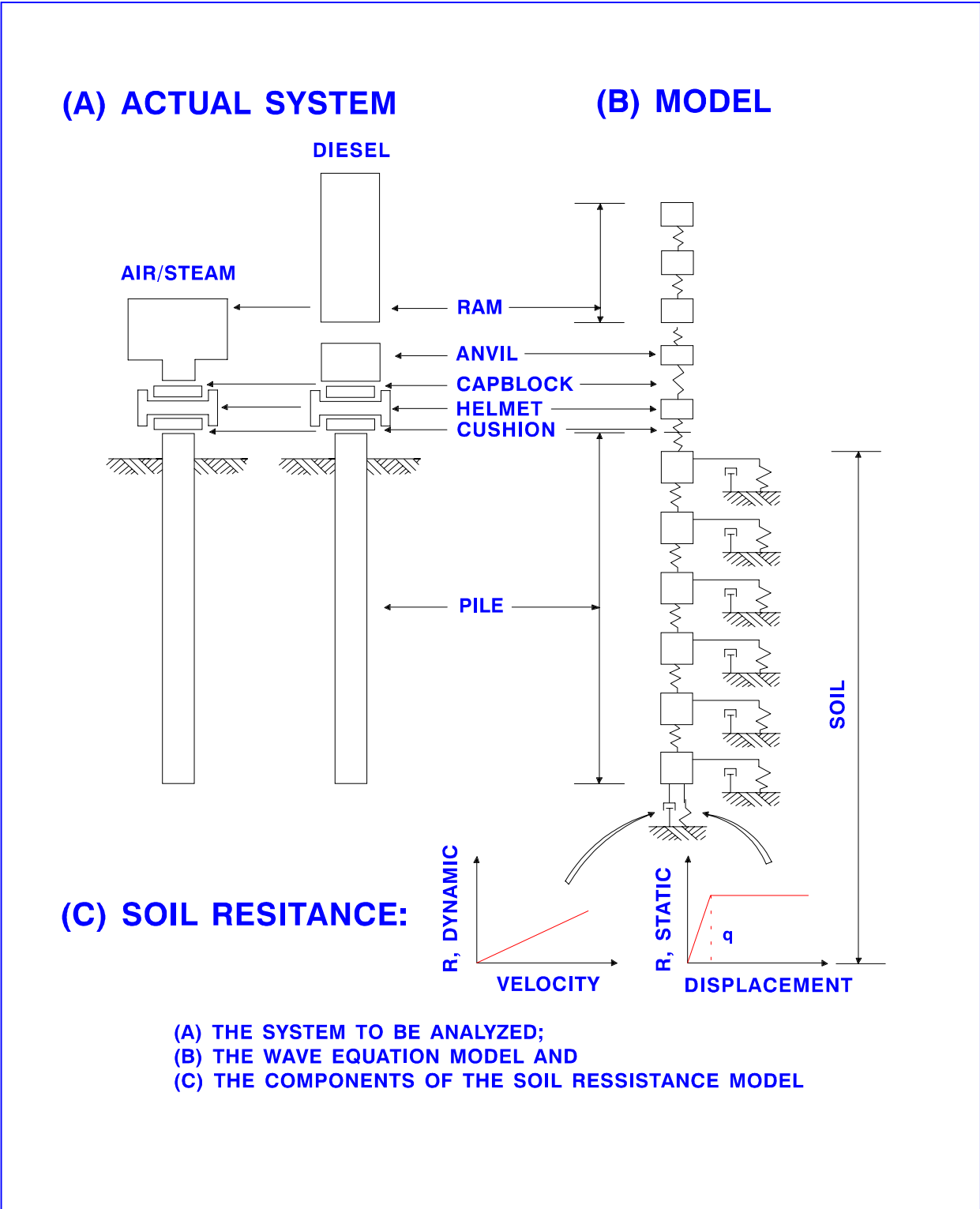

Figure 14
 Formulation of Pile into a Dynamic Model
 to Solve the Wave Equation

dynamic soil resistance forces along the pile. The force pulse reaching the pile toe will generate a reflected force pulse (tension or compression) governed by the soil resistance at the pile toe. The pile will penetrate into the soil and have a permanent set when the peak force generated by the ram impact exceeds the combined static and dynamic resistance at the pile toe.

1.6.3 Wave Equation Application. The wave equation analysis provides two types of information: (1) relationship between ultimate capacity and driving resistance, and (2) relationship between driving stresses in the pile and pile driving resistance.

The wave equation analysis develops curves of capacity versus driving resistance for different pile lengths. These can be used in the field to determine when the pile has been driven sufficiently to develop the required capacity.

In the design stage, the wave equation analysis is used to: (1) design the pile section for driveability to the required depth and/or capacity, and (2) determine required pile material properties to be specified based on probable driving stresses in reaching penetration and/or capacity requirements.

In the construction stage, the wave equation analysis is used by: (1) construction engineers for hammer approval; and (2) contractors to select the right combination of driving equipment to minimize driving costs.

1.6.4. Dynamic Testing of Piles. A method (ASTM D 4945, High-Strain Dynamic Testing of Piles) of computing driving resistance from field instrumentation, named CAPWAP, using wave equation analysis has been described by Wave Equation Analysis of Pile Driving, Goble and Rausche, 1960. Accelerometers and strain transducers are fitted near to the head of a pile and the readings from these during the course of a hammer blow are processed to give plots of force and velocity versus time as shown in Figure 15. The second stage of the method involves running a wave equation analysis, but with the pile modeled only from the instrument location downward. Values of soil

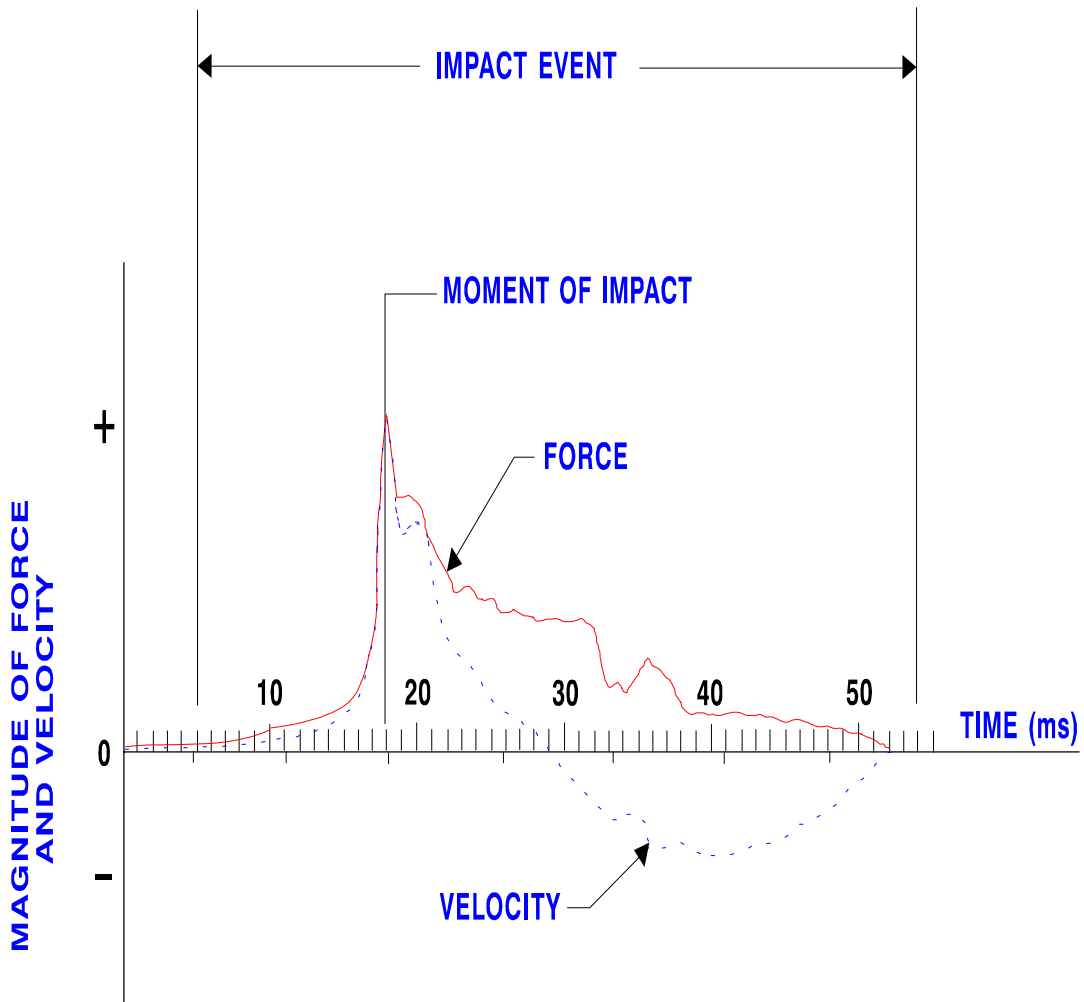

Typical Force and Velocity Traces Generated by the Apparatus for Obtaining Dynamic Measurements

Figure 15
Example of Force and Velocity Near to Head of Pile During Driving

resistance, quake, and damping are assigned, and the recorded time varying velocity is applied as the boundary condition at the top of the pile model. The analysis will generate a force-time plot for the instrument location, and this is compared with the recorded force-time plot. Adjustments are made to the values of resistance, quake, and damping, and further analysis run until agreement between the computed and recorded force-time plot is acceptable. At this stage the total soil resistance assigned in the analysis can be taken to be the resistance at time of driving.

1.6.5 Results From Dynamic Testing. The main objectives of dynamic pile testing are:

a) Assess bearing capacity at the time of test driving. For the prediction of a pile's long term bearing capacity, measurements are taken during restriking after soil has been set up around test pile.

b) Monitor dynamic pile stress during pile driving. To limit the possibility of pile damage, stresses must be kept within certain bounds. For concrete piles both tension and compression stresses are important.

c) Check pile integrity both during and after pile installation.

d) Check hammer performance for productivity and construction control.

1.6.6 Pile Dynamic Measurement. A device called the pile driving analyzer (PDA) which uses electronic measurements and the wave equation analysis method has been developed by Goble Rausche Likins and Associates, Inc. (GRL). The basis for the results calculated by the PDA are pile top force and velocity signals, obtained using piezoelectric accelerometers and bolt-on strain transducers attached to the pile near its top. The PDA conditions and calibrates these signals and immediately computes average pile force and velocity.

1.6.7 Applications. This test method is used to provide data on strain or force and acceleration, displacement, and velocity of a pile under impact force. The data may be used to estimate the bearing capacity and the integrity of the pile, as well as hammer performance, pile stresses, and soil dynamics characteristics, such as soil damping coefficients and quake values.

1.6.7.1 Apparatus for Applying Impact Force. Before the start of pile driving, the user carefully selects the pile driving hammer that is capable of driving the pile to produce measurable pile displacements in subsequent restriking. Too small a hammer, even though it may be able to drive the pile to required embedment initially, may not be able to overcome the soil resistance upon restriking even if the pile is just over the design capacity. Too large a hammer may damage the pile by exceeding allowable compression or tension stresses. The wave equation analysis gives the tensile stresses generated by the hammer. If necessary, the pile prestress level can be adjusted if the anticipated tension stress exceeds the allowable stress.

Among other uses, the PDA can be employed for a quick check for pile bearing capacity, but not to replace pile load testing entirely. Restriking the pile provides a bearing capacity check when pore water pressure and soil conditions have stabilized after initial driving.

1.6.7.2 Impact Force Application. The impact force is applied axially and uniformly. The system should use a suitable pile helmet and thickness of pile cushion to protect pile head and preclude excessive tensile stress during the initial driving. During pile driving, the engineers continue to use PDA and monitor the behavior of the pile, hammer, stresses, and soil resistance. Accurate blow count records are kept. PDA will not provide blow count records automatically. Accurate distance markers must be kept for blow count purposes. In the inch-pound system, every foot (or every inch if number of blows per inch is important) should be accurately kept for blow count records. In SI metric units, every 250 mm and meter are marked. Every 25 mm or every 5 blows per set recording is marked. For a blow vs. set recording, paper is attached to the pile face and a

horizontal line drawn before and after each blow, for example by sliding a pencil across the paper. The pencil can be attached to the end of a long handle and a smooth horizontal lumber used as guide.

The test pile is struck with the PDA setup to check the pile bearing capacities after the pile has been installed for a sufficient amount of time.

1.6.7.3 Apparatus for Obtaining Dynamic Measurement. The apparatus includes transducers, which are capable of independently measuring strain and acceleration versus time at a specific location along the pile axis during the impact event. Two of these devices are attached on opposite sides of the pile. The measured strain is converted to force using the pile cross-section area and dynamic modulus of elasticity at the measuring location.

1.6.7.4 Signal Transmission. The system use cables that will limit electronic or other interference to less than 2 percent of the maximum signal expected. The signal arriving at the apparatus will be linearly proportional to the measurement at the pile over the frequency range of equipment.

1.6.7.5 Apparatus for Recording, Reducing, and Displaying Data. The apparatus for recording, reducing, and displaying data during the impact event includes an oscilloscope or oscillograph for displaying the force and velocity traces, a tape recorder or equivalent for obtaining a record for future analysis, and a means to reduce the data.

Information is displayed through an oscilloscope or oscillograph on which the resulting force and velocity versus time can be observed for each hammer blow. The apparatus should be adjustable to reproduce a signal having a range of duration between 5 and 160 ms. Both the force and velocity data can be reproduced for each blow and the apparatus should be capable of holding and displaying the signal from each selected blow for a minimum period of 30 seconds.

Section 2: EARTHQUAKE ENGINEERING

2.1 EARTHQUAKE, WAVES, AND RESPONSE SPECTRA

2.1.1 Earthquake Mechanisms. Earthquake engineering deals with a complex problem, and it has been advanced by study of earthquake induced failures. The most important earthquakes are of tectonic origin associated with large-scale strain in the crust of the earth. Tectonic earthquakes are caused by slip along geologic faults.

Although other mechanisms such as volcanic eruptions may cause earthquakes, the overwhelming majority of earthquakes of engineering significance are generated by strain rebound associated with fault movement caused by tectonic processes. As the different plates that comprise the earth's surface move past or over and under each other, the rocks on opposite sides of the fault do not initially move past each other but instead deform, developing shear strains. Eventually the shear forces on the fault become too large for the fault to carry, and a sudden slippage occurs, releasing the built-up shear strains. The sudden release of strain energy is perceived as an earthquake.

Earthquakes can originate from motion in any direction on many different types of faults. Some involve primarily strike-slip movement. Other earthquakes may involve up-dip movement on reverse or thrusts faults or down-dip movement on normal faults. In many cases there are combination of different types of movements. The different patterns of stress and strain release associated with the various types of movements cause different patterns of acceleration with time. The study of the ground motions associated with different patterns of fault movement and the prediction of these motions for a given fault movement are subjects of ongoing research.

When the patterns of faulting that can cause earthquakes are well known, seismologists can make estimates of the motions to be expected at a given site. This situation is most likely to exist in areas of frequent seismicity where the geology and historical seismicity are well known. The region in the United States west of the Rocky Mountains, in particular, is one such area.

In most other areas the historical record is much more sparse, and the mechanisms are not well understood. Since the earthquakes cannot be related to known tectonic features, design earthquake motions have to be combinations of several recorded motions or generalized and idealized motions that are designed to cover the range of accelerations and frequencies expected.

2.1.2 Wave Propagation. An earthquake source produces two types of waves: body and surface waves. The body waves, which travel through the body of the soil or rock, can be divided into P-waves and S-waves. In P-waves the particle motion is in the direction of propagation of the wave; in S-waves the particle motion is transverse to the direction of propagation. Surface waves occur at the surface of a material or at the interface between materials of different properties. A typical earthquake accelerogram contains three main groups of waves: P, or primary; S, or secondary; L, or surface waves.

The fastest moving of the waves are the P-waves (P for primary). In these waves the particles move back and forth in the direction of propagation, so the wave consists of alternate compression and extension. In a medium of mass density ρ with shear modulus G and Poisson's ratio ν , the speed of propagation V_p is:

$$V_p = [2G(1-\nu)/\rho(1-2\nu)]$$

The second type of wave is the S-wave (S for secondary). In these waves the particle motion is transverse to the direction of propagation, so these waves are also called shear waves. The velocity of propagation V_s is:

$$V_s = (G/\rho)^{1/2}$$

The ratio of V_p to V_s is

$$V_p/V_s = [2(1-\nu)/(1-2\nu)]^{1/2}$$

which is always greater than 1.0 for realistic values of Poisson's ratio. When Poisson's ratio is 0.25, this ratio becomes 1.73, a number that is frequently cited as typical of the ratio of the two velocities.

In an S-wave the particle motions can be in any direction in a plane perpendicular to the direction of propagation. It is often convenient to divide this motion into two components: one in which all the particle motion is horizontal, and the other containing the remaining portion of the motion. Because the particles move horizontally, the first is called an SH wave. In addition, the particle may have some vertical motion in the second component, it is called an SV wave. Note that an SV wave usually has some horizontal motion as well as vertical.

Stress waves obey Snell's Laws of reflection and refraction. An upwardly propagating SH wave impinging on a horizontal surface will generate a refracted SH wave above the surface and a reflected SH wave below it. If the upper material is not as stiff as the lower material, the direction propagation will be closer to the vertical in the upper material. SV and P waves are similarly refracted and reflected. In addition SV waves will generate refracted and reflected P waves, and P waves will generate refracted and reflected SV waves. Once a wave train has passed through several interfaces, the pattern can become very complex.

In addition to the body waves, stress waves occur at the surface of an elastic medium. The most important of these are the Rayleigh waves. In these waves the particle motion describes an ellipse whose horizontal axis is in the direction of propagation. The motions are retrograde; that is, the particle motions are opposite to the type of motion in a breaking ocean wave. The amplitude of motion in Rayleigh waves decreases with depth. The velocity of propagation is a function of Poisson's ratio, but it is approximately 90 percent of the shear wave velocity.

2.1.3 The Response Spectrum. The frequency content of the earthquake record is an important feature of seismic motion. A Fourier analysis, transforming the time-based data into the frequency domain, provides useful information on the frequency-dependent energy distribution.

The time history of ground motion is usually a complicated function that reflects the interaction of many waves

generated from different parts of the causative fault and refracted through several geologic strata. While such strong motion time histories can be used directly in computerized engineering computations, a useful simplification is the response spectrum.

The response spectrum is generated by assuming a series of SDOF systems with different resonant frequencies and the same critical damping ratio. The time history of motion is used as base motion for the model of each SDOF system. The response is expressed in terms of the relative displacement between the base and vibrating mass, and the maximum value of the relative displacement S_d for each frequency of SDOF system. The plot of S_d versus frequency f or versus the period T , which is the inverse of f , is called the response spectrum for a given value of critical damping ratio.

If the motion lasts long enough, it can be assumed that the mass is moving in simple harmonic motion at a frequency f . Then the amplitude of the absolute velocity S_v will be:

$$S_v = 2\pi f S_d$$

and the amplitude of the absolute acceleration S_a will be:

$$S_a = 4\pi^2 f^2 S_d$$

Thus, the response spectrum in terms of S_d also yield the spectra for S_v and S_a without further response analyses.

A convenient way to present these results is the tripartite plot shown by Figure 16. In this plot, because S_a and S_v can be computed directly from S_d and f , all the results are represented by one point in the log-log plot. For example, suppose $f = 2$ Hz ($T = 1/f = 0.5$) and $S_d = 2$ in (5.1 cm). Then:

$$S_v = (2\pi)(2)(2) = 25.1 \text{ in/sec} = 63.8 \text{ cm/sec}$$

$$S_a = (4\pi^2)(2)^2(2)[2.54/980] = 0.82g$$

This point is identified as Point A in the figure. The tripartite plot is often drawn with period T as the horizontal axis instead of frequency f . In many cases response spectra are plotted for different values of D on the same plot. Another common practice is to combine the response spectra from different time histories to obtain a representative spectrum for design purposes.

To use the response spectrum, the engineer must first calculate the resonant frequency (or period) of the facility to be analyzed and estimate its internal damping ratio. The related displacement, absolute velocity, and absolute acceleration of the mass can be found directly from the response spectrum.

Figure 16 shows the 5 percent damped response spectrum for an indicated earthquake at a site for 10 percent exceedance in 100 years (950-year average return period). Table 4 shows the computation of the 5 percent spectral damping.

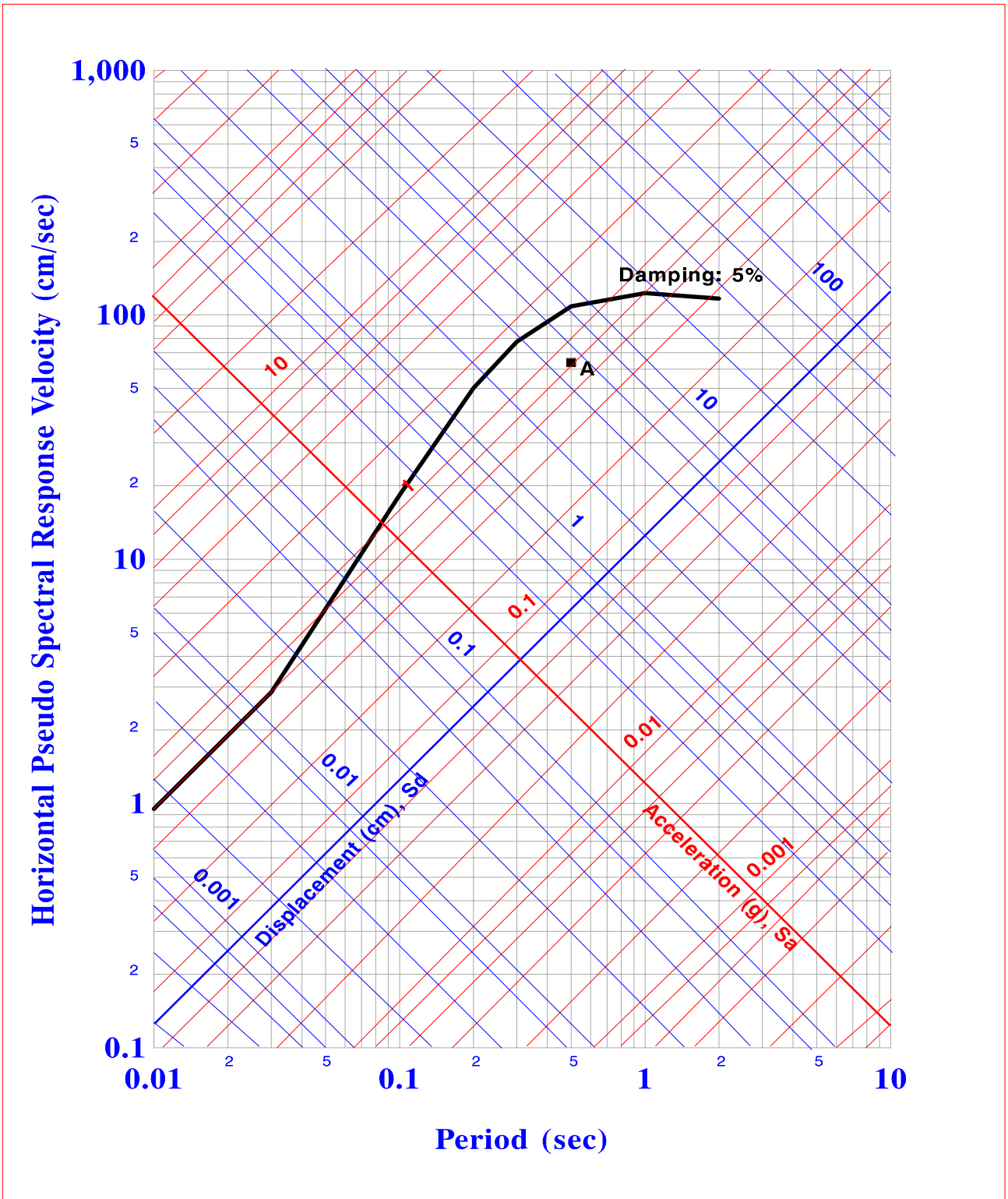

Figure 16
Tripartite Diagram of Response Spectra - 5 Percent Damping

Table 4
Spectral Ordinates - 5 Percent Damping

No.	Period (s)	Frequency (Hz)	Sa (g)	Sv (cm/s)	Sv (in/s)	Sd (cm)	Sd (in)
1	0.030	33.33	0.609	2.85	1.12	0.014	0.005
2	0.100	10.00	1.170	18.28	7.20	0.291	0.115
3	0.200	5.00	1.604	50.11	19.73	1.595	0.628
4	0.300	3.33	1.659	77.74	30.61	3.712	1.461
5	0.500	2.00	1.388	108.41	42.68	8.627	3.396
6	1.000	1.00	0.785	122.62	48.28	19.516	7.683
7	2.000	0.50	0.373	116.53	45.88	37.092	14.603

Two points related to the response spectrum should be noted. First, the method is derived for an SDOF and should be applied to SDOF systems. When multiple degrees of freedom occur, more advanced techniques should be used. Second, the method gives the maximum response but provides no information on when that response occurs. All data on time and phasing are lost in developing the response spectrum.

2.2 SITE SEISMICITY

2.2.1 Site Seismicity Study. The objective of a seismicity study is to quantify the level and characteristics of ground motion shaking that pose a risk to a site of interest. A seismicity study starts with detailed examination of available geological, historical, and seismological data to establish patterns of seismicity and to locate possible sources of earthquakes and their associated mechanisms. The site seismicity study produces a description of the earthquake for which facilities must be designed. In many cases, this will take the form of a probability distribution of expected site acceleration (or other measurements of ground motion) for a given exposure period and also give an indication of the frequency content of that motion. In some cases typical ground motion time histories called scenario earthquakes are developed. One approach is to use the historical epicenter database in conjunction with available geological data to form a best estimate regarding the probability of site ground motion.

Figure 17 explains some terms that are commonly used in seismic hazard analysis. The "hypocenter" or "focus" is the point at which the motions originated. This is usually the point on the causative fault at which the first sliding occurs. It is not necessarily the point from which greatest energy is propagated. The "epicenter" is the point on the ground surface that lies directly above the focus. The "focal depth" is the depth of the focus below the ground surface. The "epicentral distance" is the distance from the epicenter to the point of interest on the surface of the earth.

As a part of the Navy's Seismic Hazard Mitigation Program, procedures were developed in the form of a computer program (named SEISMIC, NAVFACENGCOTM Technical Report TR-2016-SHR, Procedures for Computing Site Seismicity, and Acceleration in Rock for Earthquakes in the Western United States, Schnabel and Seed, 1973) designed to run on standard desktop DOS-based computers. The procedures consist of:

- a) Evaluating tectonics and geologic settings,
- b) Specifying faulting sources,

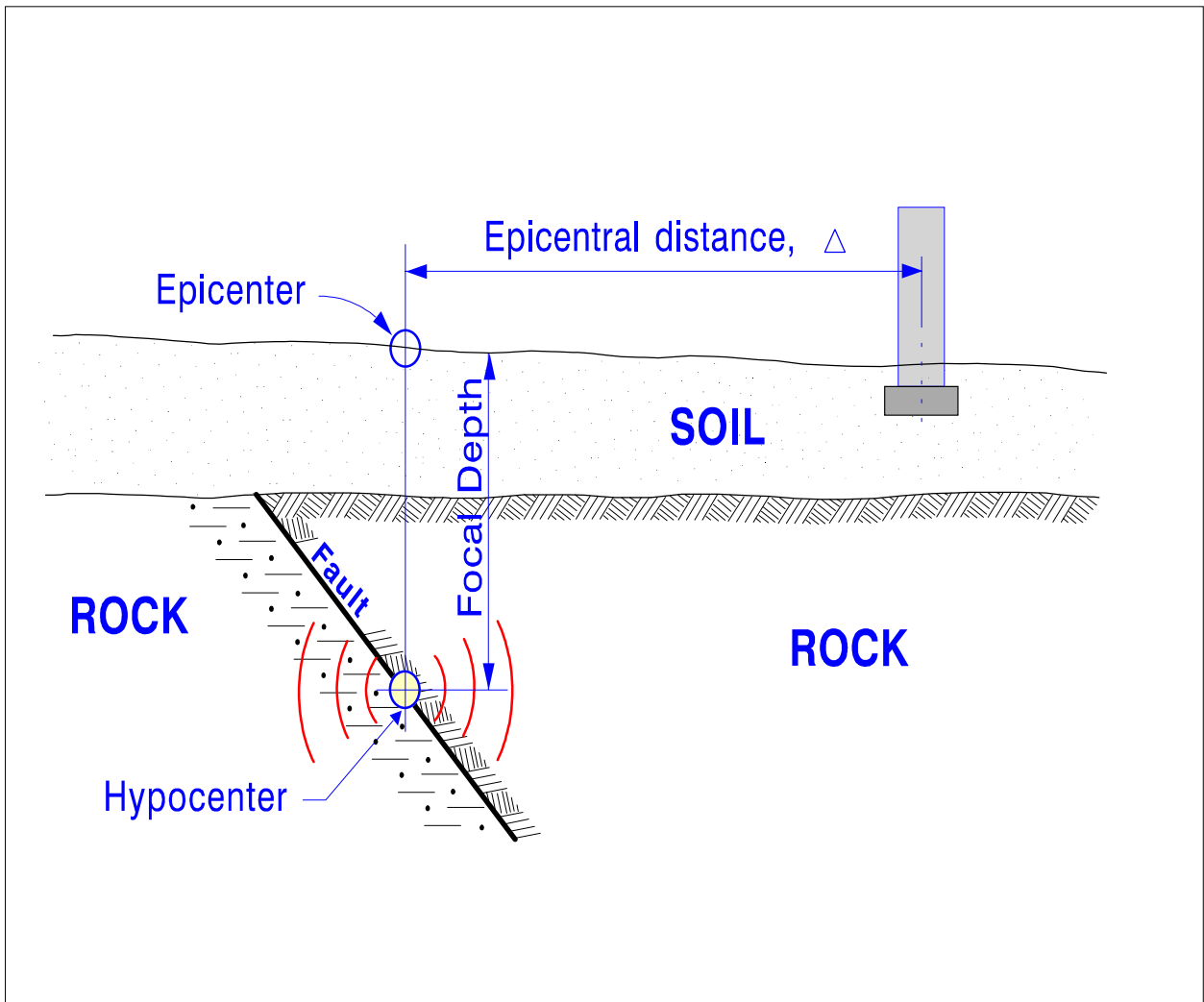

Figure 17
Definition of Earthquake Terms

- c) Determining site soil conditions,
- d) Determining the geologic slip rate data,
- e) Specifying the epicenter search area and search of database,
- f) Specifying and formulating the site seismicity model,
- g) Developing the recurrence model,
- h) Determining the maximum source events,
- i) Selecting the motion attenuation relationship,
- j) Computing individual fault/source seismic contributions,
- k) Summing the effects of the sources,
- l) Determining the site matched spectra for causative events.

2.2.2 Ground Motion Estimates. Ground motion attenuation equations are used to determine the level of acceleration as a function of distance from the source and magnitude of the earthquake. Correlations have been made between peak acceleration and other descriptions of ground motion with distance for various events. These equations allow the engineers to estimate both the ground motions at a site from a specified event and the uncertainty associated with the estimate. There are a number of attenuation equations that have been developed by various researchers. Donovan and Bornstein, 1978, developed the following equation for peak horizontal acceleration from the Western United States data.

$$Y = a \exp(b M)(r + 25)^d$$

$$a = 2,154,000(r)^{-2.10}$$

$$b = 0.046 + 0.445 \log(r)$$

$$d = 2.515 + 0.486 \log(r)$$

where: Y = peak horizontal acceleration (gal)
(one gal = 1 cm/sec²)

M = earthquake magnitude

r = distance (km) to the energy center, default
at a depth of 5 km

2.2.3 Analysis Techniques. NAVFAC P-355.1, Seismic Design Guidelines for Essential Buildings provides instructions for site seismicity studies for determining ground motion and response spectra. An automated procedure has been developed by NFESC (Naval Facilities Engineering Service Center) to perform a seismic analysis using available historic and geological data to compute the probability of occurrence of acceleration at the site. A regional study is first performed in which all of the historic epicenters are used with an attenuation relationship to compute site acceleration for all historic earthquakes. A regression analysis is performed to obtain regional recurrence coefficients, and a map of epicenters is plotted. Confidence bounds are given on the site acceleration as a function of probability of exceedance.

An example of a site specific study is given in paragraph 2.4.2, Figure 21.

2.3 SEISMIC SOIL RESPONSE

2.3.1 Seismic Response of Horizontally Layered Soil Deposits. Several methods for evaluating the effect of local soil conditions on ground response during earthquakes are now available. Most of these methods are based on the assumption that the main responses in a soil deposit are caused by the upward propagation of horizontally polarized shear waves (SH waves) from the underlying rock formation. Analytical procedures based on this concept incorporating linear approximation to nonlinear soil behavior, have been shown to give results in fair agreement with field observations in a number of cases. Accordingly, engineers are finding increasing use in earthquake engineering for predicting response within soil deposits and the characteristics of ground surface motions.

2.3.2 Evaluation Procedure. The analytical procedure generally involves the following steps:

a) Determine the characteristics of the motions likely to develop in the rock formation underlying the site, and select an accelerogram with these characteristics for use in the analysis. The maximum acceleration, predominant period, and effective duration are the most important parameters of an earthquake motion. Empirical relationships between these parameters and the distance from the causative fault to the site have been established for earthquakes of different magnitudes. A design motion with the desired characteristics can be selected from the strong motion accelerograms that have been recorded during previous earthquakes or from artificially generated accelerograms.

b) Determine the dynamic properties of the soil deposit. Average relationships between the dynamic shear moduli and damping ratios of soils, as functions of shear strain and static properties, have been established for various soil types (Hardin and Drnevich, 1970, Seed and Idriss, 1970). Thus a testing program to obtain the static properties for use in these relationships will often serve to establish the dynamic properties with a sufficient degree of accuracy. However more elaborate dynamic testing procedures are required for special problems and for cases involving soil types for which empirical relationships with static properties have not been established.

c) Compute the response of the soil deposit to the base rock motions. A one-dimensional method of analysis can be used if the soil structure is essentially horizontal. Computer programs developed for performing this analysis are generally based on either the solution to the wave equation or on a lumped mass simulation. More irregular soil deposits may require a finite element analysis.

2.3.3 Analysis Using Computer Program. A computer program, SHAKE (Schnabel et al. 1971), which is based on the one-dimensional wave propagation method is available. The program can compute the responses for a design motion given anywhere in the system. Thus acceleration obtained from instruments on soil deposits can be used to generate new rock motions which, in turn, can be used as design motion for other soil deposits. Figure 18 shows schematic representation of the procedure for computing effects of local soil conditions on ground motions. If the ground motions are known or specified at Point A, the SHAKE program can be used to compute the motion to the base of the soil column. That is, the program finds the base rock motion that causes the motion at Point A. The program can then find what the motion would be at a rock outcrop if the base rock motion had been propagated upward through rock instead of soil. This rock outcrop motion is then used as input to an amplification analysis, yielding the motion at Point B, which is the top of another soil column.

The program also incorporates a linear approximation to nonlinear soil behavior, the effect of the elasticity of the base rock, and systems with different values of damping and modulus in different layers. Other versions of the same sort of analysis, often incorporating other useful features, are also available and may be superior to the original version of SHAKE. A NAVFAC sponsored MSHAKE microcomputer program was developed in 1994. The MSHAKE is a user friendly implementation of the SHAKE91 program which is a modified version of the original computer program SHAKE.

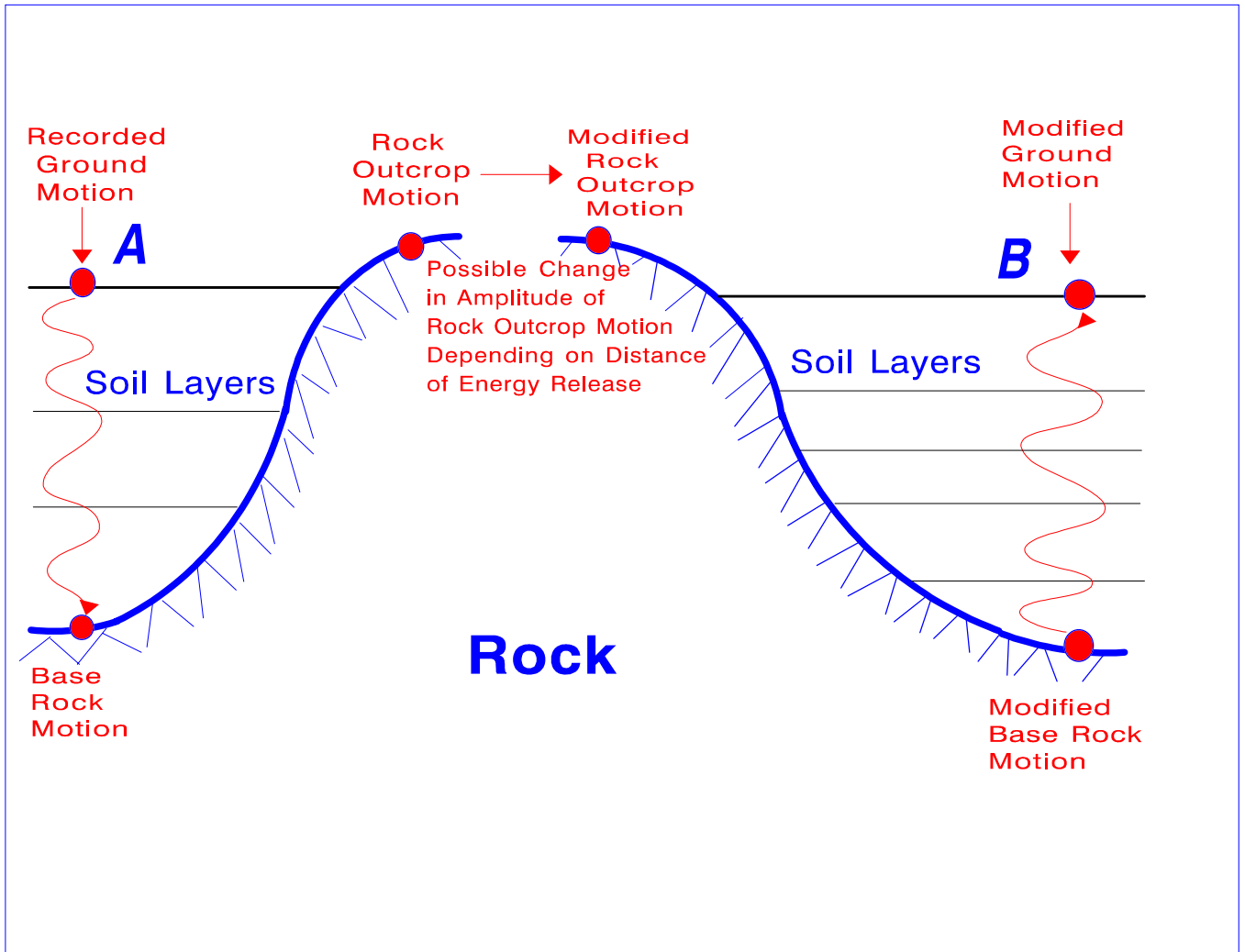

Figure 18
Schematic Representation of Procedure for Computing
Effects of Local Soil Conditions on Ground Motions

2.4 DESIGN EARTHQUAKE

2.4.1 Design Parameters. In evaluating the soil behavior under earthquake motion, it is necessary to know the magnitude of the earthquake and to describe the ground motion in terms that can be used for further engineering analysis. Historically, design earthquake waves were specified in terms of the peak acceleration, but more modern techniques use the response spectrum or one or more time histories of motion. The most reliable method for accomplishing this is to base the studies on data obtained at the site. A second choice is to find another site similar in geologic and seismic setting where ground motion was measured during a design level magnitude earthquake. However, this will usually not be possible, and estimates of ground motion based on correlations and geologic and seismologic evidence for the specific site become necessary.

2.4.1.1 Factors Affecting Ground Motion. Factors that affect strong ground motion include:

a) Wave types - S and P waves that travel through the earth, and surface waves that propagate along the surfaces or interfaces.

b) Earthquake magnitude - There are several magnitude scales. Even a small magnitude event may produce large accelerations in the near field, and a wide variety of acceleration for the same magnitude may be expected.

c) Distance from epicenter or center of energy release.

d) Site conditions.

e) Fault type, depth, and recurrence interval.

2.4.1.2 Ground Motion Parameters. Ground motion parameters have been correlated with magnitude and distance by several investigators. The correlation in Figure 19 (Schnabel and Seed, 1973), is based on ground motion records from the Western United States and is believed more applicable to small and moderate earthquakes (magnitudes 5.5 and 6.5) for rock. This correlation is also statistically applicable for stiff soil sites (e.g., where overburden is of stiff clays and dense sands less than 150

feet thick). For other site conditions, motion may occur as illustrated in Figure 20 (Relationship Between Maximum Acceleration, Maximum Velocity, Distance From Source and Local Site Conditions for Moderately Strong Earthquake, Seed, Murnaka, Lysmer, and Idris, 1975).

2.4.2 Site Specific Studies. In areas where faults are reasonably mapped and studied, site specific investigations can verify if such faults are trending towards the site or if the facility is on an active fault. Studies may involve trenching and mapping, geophysical measurements, and other investigation techniques. The extent of the area to be investigated depends on geology and the type and use of the structure. In some localities, state, or local building codes establish minimum setback distances from active faults. Unless other critical conditions demand differently, provide 300 feet minimum distance from an active fault. For essential facilities the distance should be increased appropriately.

In seismically active areas where faults are not well mapped, site specific investigations may be required. Regional investigations may also be required. Other hazards to be considered in a site investigation include the potential for liquefaction and sliding.

Site studies are now being made for naval activities located in Seismic Zones 3 and 4. These studies in conjunction with the soil data for the project should generally be adequate to assess the seismic hazard. An example of total probability of site acceleration made for North Island, San Diego, California is shown in Figure 21. Individual studies have been made for existing hospitals and drydocks located in Seismic Zones 3 and 4. A site study may occasionally be warranted for essential facilities to be located in Seismic Zone 2, if the mission is sensitive to earthquake damage. A critical structure (where earthquake damage could create a life endangering, secondary hazard) requires special consideration in all earthquake zones.

2.4.3 Earthquake Magnitude. Design earthquake magnitude and selection of magnitude level are discussed below.

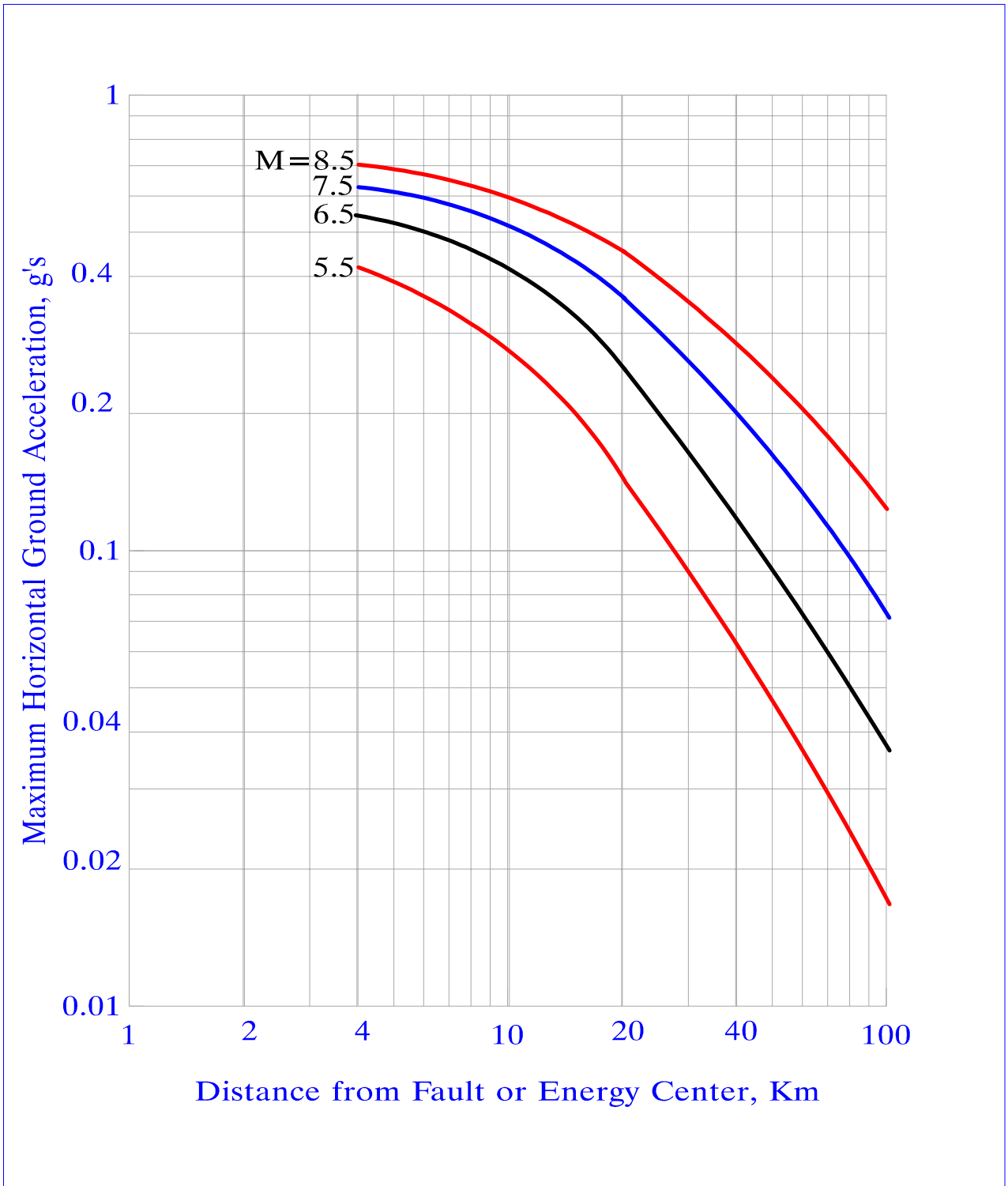

Figure 19
Example of Attenuation Relationships in Rock

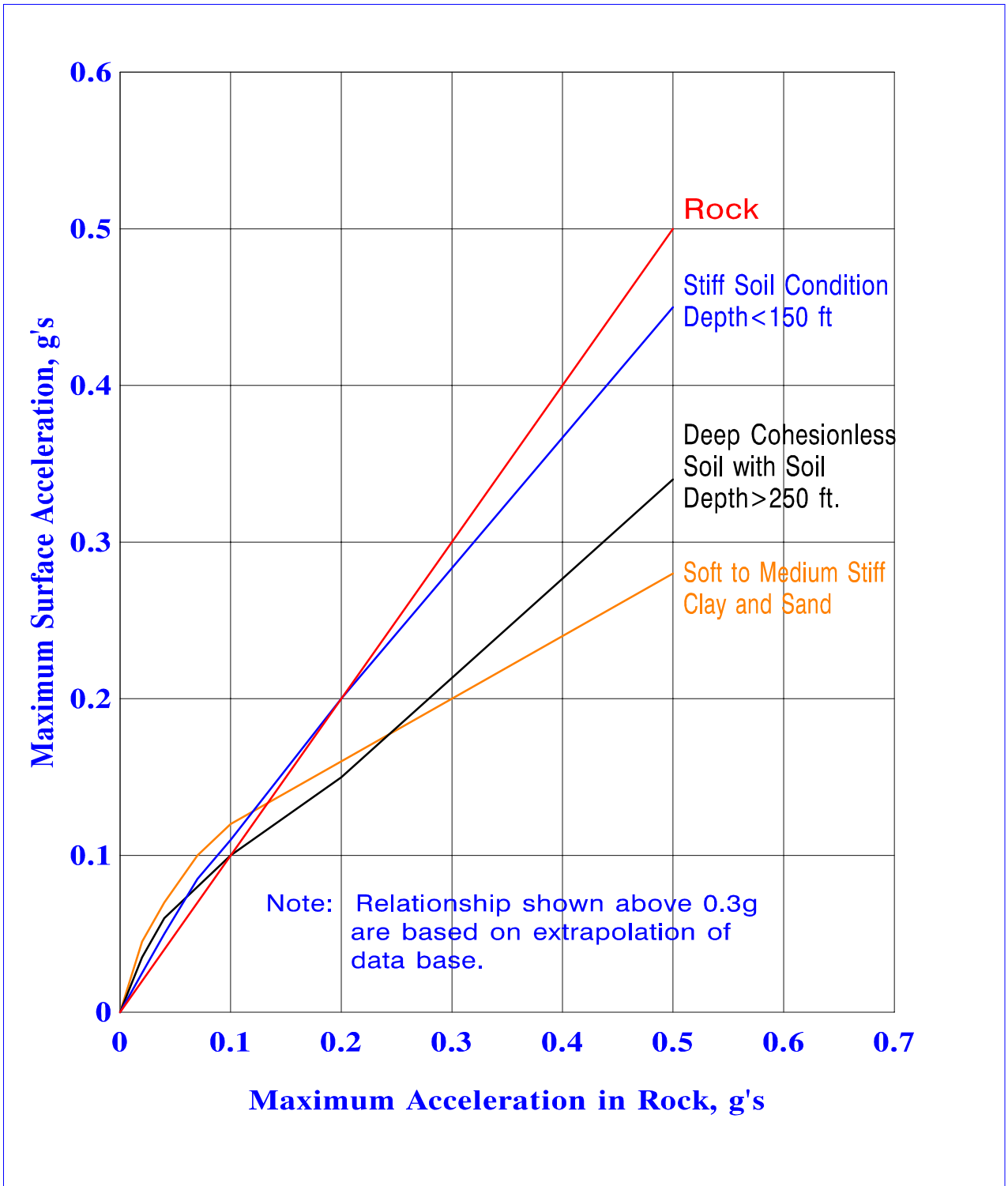

Figure 20
 Approximate Relationship for Maximum Acceleration in
 Various Soil Conditions Knowing Maximum Acceleration in Rock

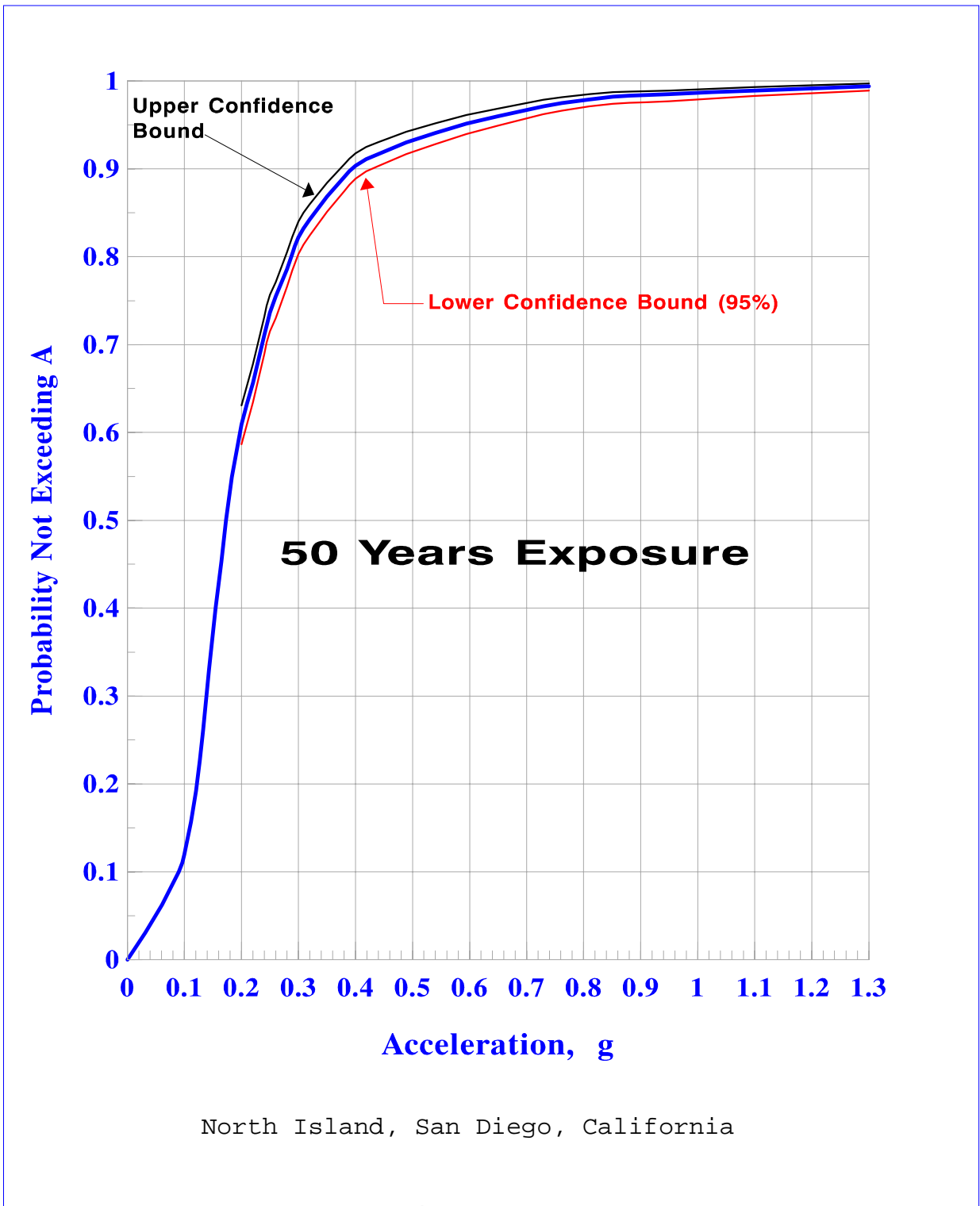

Figure 21
Example Probability of Site Acceleration

2.4.3.1 Design Earthquake Magnitude. Engineers can define a design earthquake for a site in terms of the earthquake magnitude, M , and the strength of ground motion. Factors that influence the selection of a design earthquake are the length of geologic fault structures, relationship between the fault and the regional tectonic structure, the rate of displacement across the fault, the geologic history of displacement along the structure, and the seismic history of the region.

The design earthquake in engineering terms is a specification of levels of ground motion that the structure is required to survive successfully with no loss of life, acceptable damage, or no loss of service. A design earthquake on a statistical basis considers the probability of the recurrence of a historical event.

Earthquake magnitudes can be specified in terms of a design level earthquake that can reasonably be expected to occur during the life of the structure. As such, this represents a service load that the structure must withstand without significant structural damage or interruption of a required operation. A second level of earthquake magnitude is a maximum credible event for which the structure must not collapse; however, significant structural damage can occur. The inelastic behavior of the structure must be limited to ensure the prevention of collapse and catastrophic loss of life.

2.4.3.2 Selection of Design Earthquake. The selection of a design earthquake may be based on:

a) Known design-level and maximum credible earthquake magnitudes associated with a fault whose seismicity has been estimated.

b) Specification of probability of occurrence for a given life of the structure (such as having a 10 percent chance of being exceeded in 50 years).

c) Specification of a required level of ground motion as in a code provision.

d) Fault length empirical relationships.

The original magnitude scale proposed by Gutenberg and

Richter is calculated from a standard earthquake, one which provides a maximum trace amplitude of 1 mm on a standard Wood-Anders on torsion seismograph at a distance of 100 km. Magnitude is the \log^{10} of the ratio of the amplitude of any earthquake at the standard distance to that of the standard earthquake. Each full integer step in the scale (two to three, for example) represents an energy increase of about 32 times.

Because of the history of seismology, there are actually several magnitude scales. Modern earthquakes are described by the moment magnitude, M_w . Earlier events may be described by any of a number of other scales. Fortunately, the numerical values are usually within 0.2 to 0.3 magnitude units for magnitudes up to about 7.5. For larger events the values deviate significantly.

2.4.4 Intensity. In areas where instrumental records are not available the strength of an earthquake has usually been estimated on the basis of the modified Mercalli (MM) intensity scale. The MM scale is a number based mostly on subjective description of the effects of earthquakes on structures and people. Intensity is a very qualitative measure of local effects of an earthquake. Magnitude is a quantitative measure of the size of the earthquake at its source. The MM intensity scale has been correlated with peak horizontal ground acceleration by several investigators, as illustrated in Figure 22.

2.4.5 Peak Horizontal Ground Acceleration. NAVFAC has conducted seismic investigations of activities located in Seismic Zones 3 and 4. These seismic investigations include a site seismicity study. Where such studies have been completed, they provide to determine the peak horizontal ground acceleration. Where a site seismicity study has not yet been completed, it may be warranted in connection with the design and construction of an important new facility. Consult NAVFAC for the status of site seismicity investigations. In connection with soil related calculations, the peak horizontal ground acceleration for Seismic Zone 2 may be taken as 0.17g and for Seismic Zone 1 as 0.1g. Locations of Seismic Zones 1 through 4 are given in NAVFAC P-355.1.

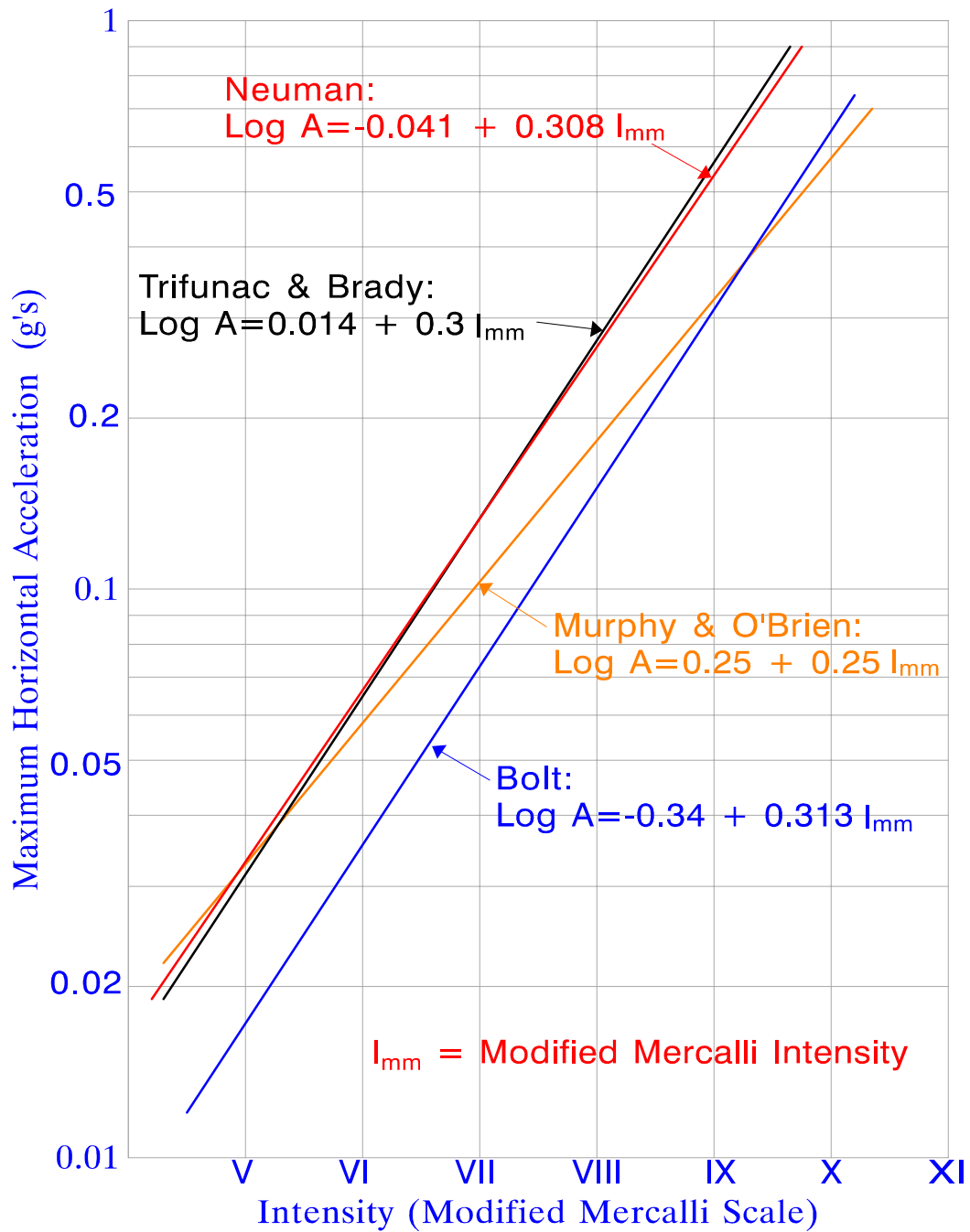

Figure 22
 Approximate Relationships Between Maximum Acceleration and
 Modified Mercalli Intensity

2.4.6 Seismic Coefficients. The values of seismic ground

acceleration can be determined from Table 5 based on soil types defined as follows:

a) Rock with $2500 \text{ ft/sec} < V_s < 5000 \text{ ft/sec}$ ($760 \text{ m/sec} < V_s < 1520 \text{ m/sec}$)

b) Very dense soil and soft rock with $1200 \text{ ft/sec} < V_s < 2500 \text{ ft/sec}$ ($360 \text{ m/sec} < v_s < 760 \text{ m/sec}$)

c) Stiff soil with $600 \text{ ft/sec} < v_s < 1200 \text{ ft/sec}$ ($183 \text{ m/sec} < v_s < 365 \text{ m/sec}$)

d) A soil profile with $v_s < 600 \text{ ft/sec}$ (183 m/sec) or any profile with more than 10 ft (3 m) of soft clay defined as soil with $PI > 20$, $w > 40$ percent, and $s_u \leq 500 \text{ psf}$ (24 kpa)

The parameter A_a is the ground acceleration for rock with no soil.

Table 5
Peak Ground Acceleration Modified for Soil Conditions

Soil Type	$A_a=0.10g$	$A_a=0.20g$	$A_a=0.30g$	$A_a=0.40g$	$A_a=0.50g$
A	0.10	0.20	0.30	0.40	0.50
B	0.12	0.24	0.33	0.40	0.50
C	0.16	0.28	0.36	0.44	0.50
D	0.25	0.34	0.36	0.46	SI

A_a = Effective peak acceleration

SI = Site specific geotechnical investigation and dynamic site response analyses are performed.

Note: Use straight line interpolation for intermediate values of A_a .

2.4.7 Magnitude and Intensity Relationships. For purposes of engineering analysis it may be necessary to convert the maximum MM intensity of the earthquake to magnitude. The most commonly used formula is:

$$M = 1 + \frac{I_{MM}}{3}$$

The above formula was derived to fit a limited database primarily composed of Western United States earthquakes. It does not account for the difference in geologic structures or for depth of earthquakes, which may be important in the magnitude-intensity relationship.

2.4.8 Reduction of Foundation Vulnerability to Seismic Loads. In cases where potential for soil failure is not a factor, foundation ties, and special pile requirements can be incorporated into the design to reduce the vulnerability to seismic loads. Details on these are given in NAVFAC P-355.1. In cases where there is a likelihood for soil failure (e.g., liquefaction), the engineer should consider employing one of the soil improvement techniques covered in Section 5 and Section 17 this handbook.

2.5 SEISMIC LOADS ON STRUCTURES

2.5.1 Earthquake Induced Loads. Earthquake loads resulting from ground shaking primarily depend on the ground motion and lateral resistance of the structure. Basic criteria for structures at risk to earthquake induced loads are given in NAVFAC P-355.1. In a few cases, it may be appropriate to investigate dynamic soil-structure interaction. For highway bridge and waterfront structures, AASHTO design criteria and procedures may apply.

2.5.2 Foundation Loads. The allowable soil pressures due to combined static and seismic loads can usually exceed the normal allowable pressure for static loads by 1/3. However, as explained in NAVFAC P-355.1, the various types of soils react differently to shorter term seismic loading, and any increase over normal allowable static loading is to be confirmed by soil analysis. In many cases, soil analysis is desirable where foundation soils consist of loose sands and sensitive clays. In addition to static stresses existing prior to earthquake motion, random dynamic stresses are exerted on the foundation soils. The shear strength of some saturated sensitive clays may be reduced under dynamic stresses, and loose to medium dense saturated granular soils may experience a substantial reduction in volume and strength during an earthquake. Special consideration should be given to the potential loss of bearing capacity or settlement of foundations on loose granular soil or highly sensitive clay.

2.5.3 Wall Loads. Refer to NAVFAC DM-7.02, Chapter 3 for analysis of wall pressures to account for earthquake loading. Allowable stresses in walls or retaining structures are increased for transient shocks in accordance with the NAVFAC DM-2 series. Seismic design of flexible anchored sheetpile walls is covered in Section 16.

2.5.4 Base Shear. For most buildings, seismic design loads use equivalent static lateral force. The base shear (V), the total lateral force on the building, is found from the following equations (NAVFAC P-355).

$$V = C_s \times W$$

$$C_s = (ZC/R_w)I$$

$$C = 1.25 S/T^{2/3}$$

where: C_s = design base shear coefficient

W = weight of the building

ZC = site spectrum

Z = zone factor

Seismic Zone:	1	2	3	4
	----	---	---	---
Z factor	3/16	3/6	3/4	1

S = site soil factor (not less than 1.0 but not greater than 1.5)

T = building period = $0.10N$

N = number of stories above the base

R_w = response modification factor

I = importance factor

Type of Occupancy	I

Essential Facilities	1.50
High Risk Facilities	1.25
All Others	1.00

2.6 LIQUEFACTION AND LATERAL SPREADING

2.6.1 Liquefaction Considerations. In many cases damage to buildings on soft or loose soils have not been caused by inertial building loads but by differential settlement of the foundations caused by ground shaking combined with the natural variability of subsoils. Considerable damage of this sort may also occur to buildings located on fills. In seismically active regions, every effort should be made to compact any fills used for structural foundation support.

In saturated loose to medium compact granular soils seismic shocks may produce unacceptable shear strains. These strains may be the result of shear stresses exceeding the strength of a soil that softens beyond peak shear strength. The high shear deformations and decreased shear strength may also be a consequence of the progressive buildup of high pore pressures generated by seismic shaking. With no or limited drainage, cyclic shear stresses can produce a progressive buildup of pore water pressures that significantly reduce the effective stress, which controls the strength. For practical purposes, the effective stress after several cycles of shear straining may ultimately be reduced to zero, leading to liquefaction. The progressive weakening before total liquefaction is called cyclic mobility.

2.6.2 Factors Affecting Liquefaction. The character of ground motion, soil type, and in situ stress conditions are the three primary factors controlling the development of cyclic mobility or liquefaction.

The character of ground motion (acceleration and frequency content) controls the development of shear strains that cause liquefaction. For the same acceleration, higher magnitude earthquakes are more damaging because of the higher number of applications of cyclic strain.

Relatively free draining soils such as GW, GP are much less likely to liquefy than SW, SP, or SM. Dense granular soils are less likely to liquefy than looser soils. Granular soils under higher initial effective confining pressures (e.g., lower water table beneath surface, deeper soils), are less likely to liquefy. Case histories indicate that liquefaction usually occurs within a depth of 50 feet or less.

Liquefaction is more likely to occur in clean granular soils. Soils with significant contents of fines (<200 sieve) are less likely to liquefy, especially when the fines are clays.

2.6.3 Evaluation of Liquefaction Potential. Liquefaction susceptibility at a site is commonly expressed in terms of a factor of safety versus the occurrence of liquefaction. This factor is defined as the ratio between available soil resistance to liquefaction, expressed in terms of the cyclic stresses required to cause soil liquefaction, and the cyclic stresses generated by the design earthquake. Both of these parameters are commonly normalized with respect to the effective overburden stress at the depth in question. Because of difficulties in analytically modeling soil conditions at liquefiable sites, the use of empirical methods has become a standard procedure in routine engineering practice.

With the present state of knowledge the prediction of liquefaction is an approximation. However, there is general agreement that the current procedures work well for ground that is level or nearly level. The analysis for steeply sloping ground is less certain. Two basic approaches are used: one based on standard penetration tests (SPT) and the other on the cone penetration test (CPT). Although the curves drawn by Seed and others (1985) envelope most of the plotted data for liquefied sites, it is possible that liquefaction may have occurred beyond the enveloped data, but was not detected at ground surface. Consequently, a safety factor 1.2 is appropriate in engineering design. The factor to be used is based on engineering judgment with appropriate consideration given to type and importance of structure and the potential for ground deformation.

2.6.3.1 Simplified Empirical Methods. The term "simplified procedure" which was developed over the past 25 years has become the standard of practice in the United States and throughout much of the world. These methods are based on evaluation of liquefaction case histories and in situ strength characteristics such as that measured by the SPT, N values, and the CPT, q_c data. For most empirical analysis, the average earthquake-induced cyclic shear stress is estimated either from the simplified empirical equation given below or from dynamic response analysis using a computer program such as SHAKE.

a) The SPT Method. The procedure for using SPT values is as follows:

(1) Compute the cyclic stress ratio, CSR, which is related to the peak acceleration at ground surface during the design earthquake:

$$CSR = \frac{\tau_{av}}{\sigma_o', '}, = 0.65(a_{max}/g)(\sigma_o/\sigma_o')r_d$$

where: τ_{av} = average cyclic shear stress induced by design ground motion

σ_o' = initial static effective overburden stress on sand layer under consideration

σ_o = initial total overburden stress on sand layer under consideration

a_{max} = peak horizontal acceleration in g's

r_d = a stress reduction factor varying from a value of 1.0 at ground surface to a value of 0.9 at a depth of about 30 feet. If stresses and accelerations are computed directly in an amplification analysis, r_d is ignored or set to 1.0.

(2) Correction of STP values. For STP values, correct N for overburden using Figure 23:

$$N_1 = C_N \times N$$

This is the value of N that would have been measured if the effective overburden stress had been 1.0 tons/sq. ft. The value C_N is a correction factor based on the effective overburden stress. Since N is also sensitive to the energy supplied by the equipment, N_1 is further corrected to the value at 60 percent of the input energy, $(N_1)_{60}$. The combined correction is:

$$(N_1)_{60} = C_N ER_m N/60$$

where: ER_m = corresponding energy ratio in percent.

Table 6 shows the energy ratio for SPT procedures (National Research Council (NRC), Liquefaction of Soils During Earthquake, 1985).

(3) Knowing the normalized blow count, $(N_1)_{60}$, from Figure 24 estimate the cyclic resistance ratio (CRR) required to cause liquefaction for clean sands under level ground conditions based on SPT values. Note that this curve applies for earthquake magnitudes 7.5.

(4) Calculate the factor of safety against liquefaction F_s for each layer, to obtain an appropriate factor of safety compatible with the type of structure.

$$F_s = \frac{\text{CRR}}{\text{CSR}}$$

where: CRR = Cyclic resistance ratio required to cause liquefaction (obtained from figure given).

CSR = Cyclic stress ratio generated by the design earthquake.

b) The CPT Method. The procedure of using CPT data is as follows:

(1) Compute CSR as in the SPT method.

(2) Use Figure 25 to determine cyclic resistance ratio (CRR) from corrected CPT data. This chart is valid for magnitude 7.5 earthquake and clean sandy materials. The bounding curve between liquefiable and non-liquefiable materials is characterized by the following equation:

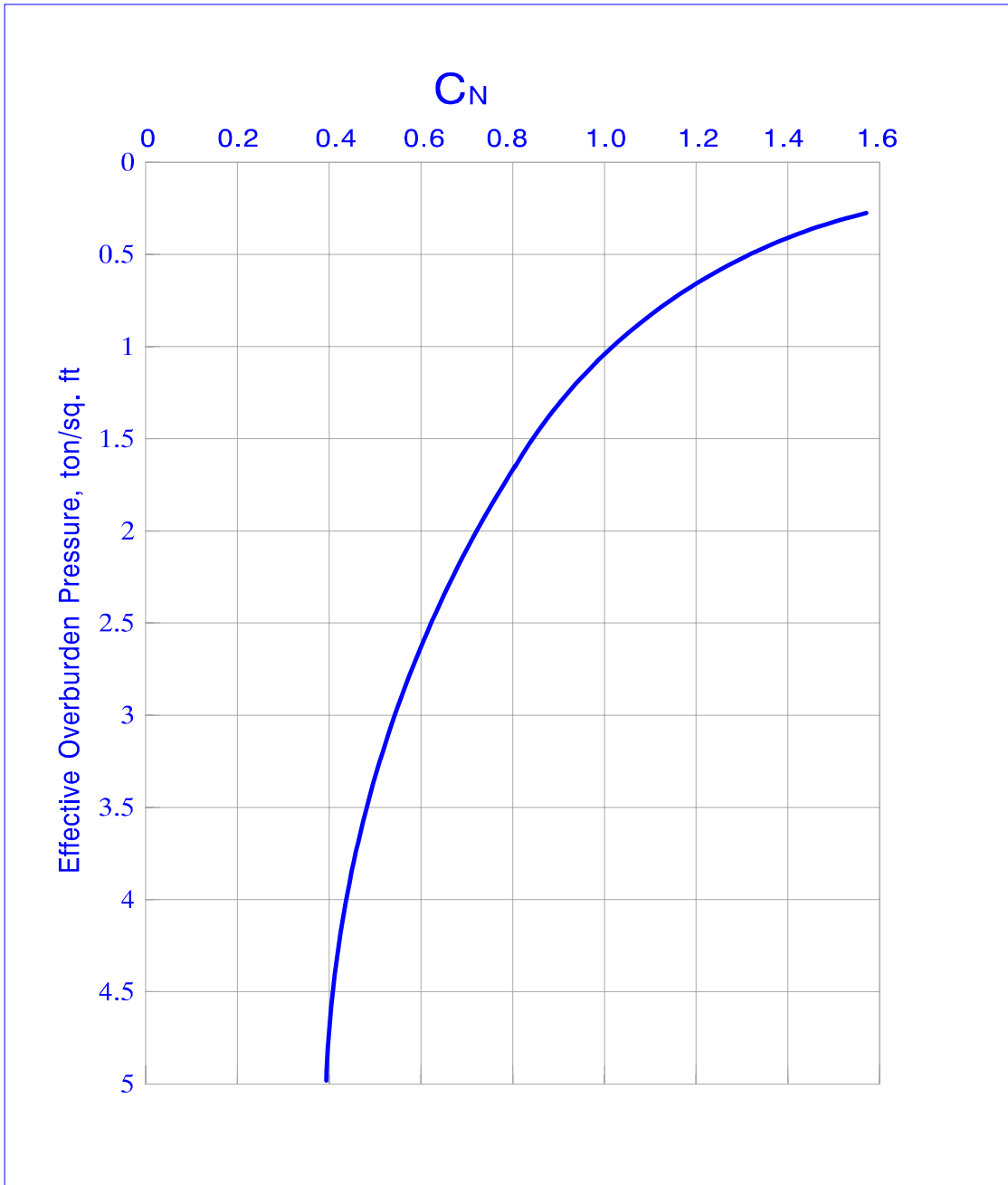

Figure 23
Correlation Between C_N and Effective Overburden Pressure

Table 6
Energy Ratio for SPT Procedures

Country	Hammer Type	Hammer Release	Estimated Rod Energy (%)	Correction Factor for 60% Rod Energy
Japan	Donut	Free-fall	78	78/60=1.30
	Donut	Rope & Pulley with Special throw release	67	67/60=1.12
U.S.A.	Safety	Rope & Pully	60	60/60=1.00
	Donut	Rope & Pully	45	45/60=0.75
Argentina	Donut	Rope & Pully	45	45/60=0.75
China	Donut	Free-fall	60	60/60=1.00
	Donut	Rope and Pully	50	50/60=0.83

$$CRR_{7.5} = 93[(q_{c1N})_{cs}/1000]^3 + 0,08$$

$$q_{c1N} = (q_c/P_a)C_Q$$

$$C_Q = (P_a/\sigma_{vo}')^{0.5}$$

Where: $(q_{c1N})_{cs}$ = equivalent clean sand cone penetration resistance normalized one atmosphere of pressure (approximately 1 tsf)

C_Q = factor to correct measured penetration resistance to one atmosphere of pressure

q_c = measured cone penetration resistance

P_a = atmospheric pressure in the same unit as cone penetration resistance and overburden pressure

σ_{vo}' = vertical effective stress existing before the imposition of cyclic loading

(3) Calculate the factor of safety, F_s , as described for using SPT method.

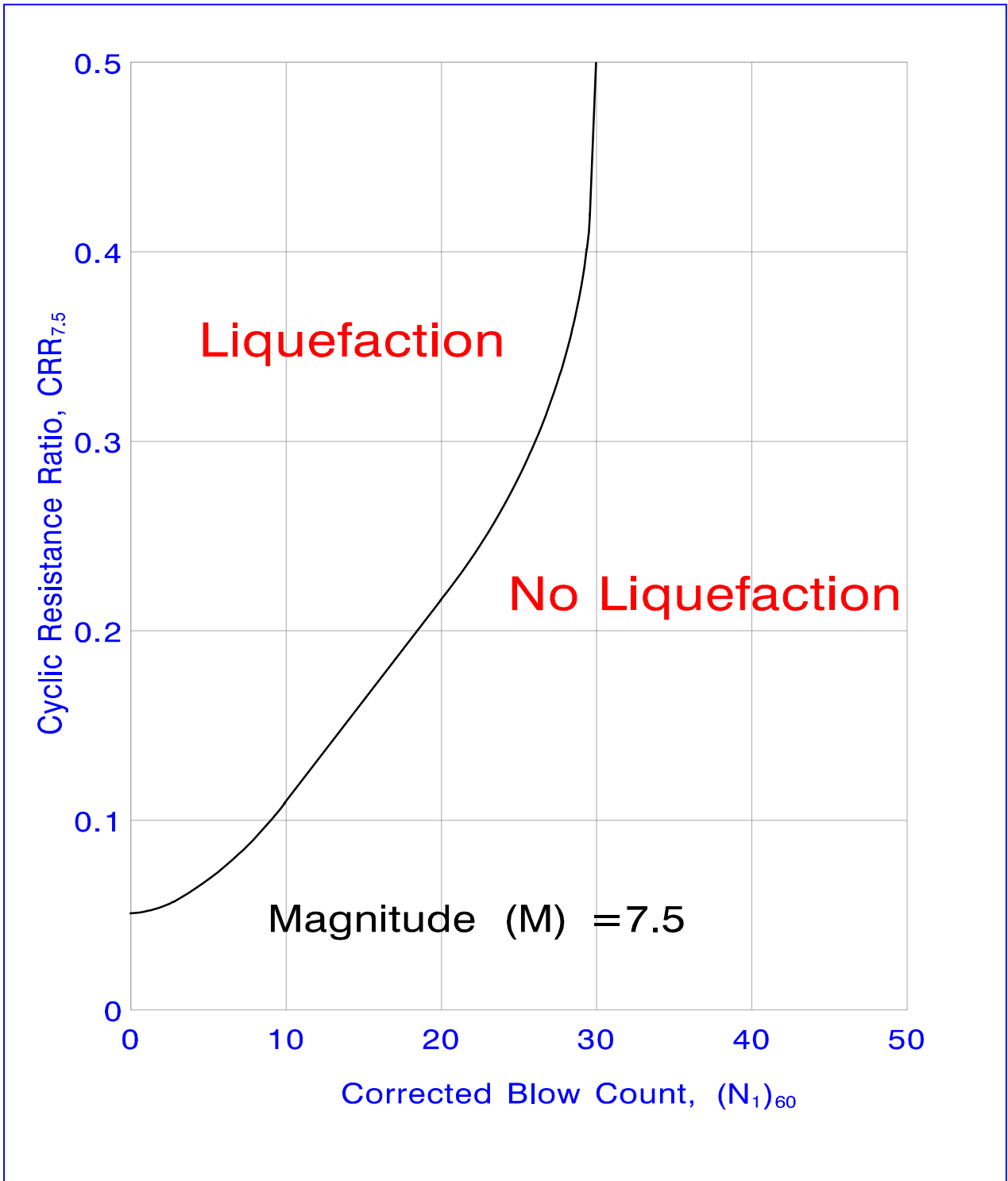

Figure 24
 Cyclic Resistance Ratio (CRR) for Clean Sands
 Under Level Ground Conditions Based on SPT
 (After Robertson and Fear, 1996)

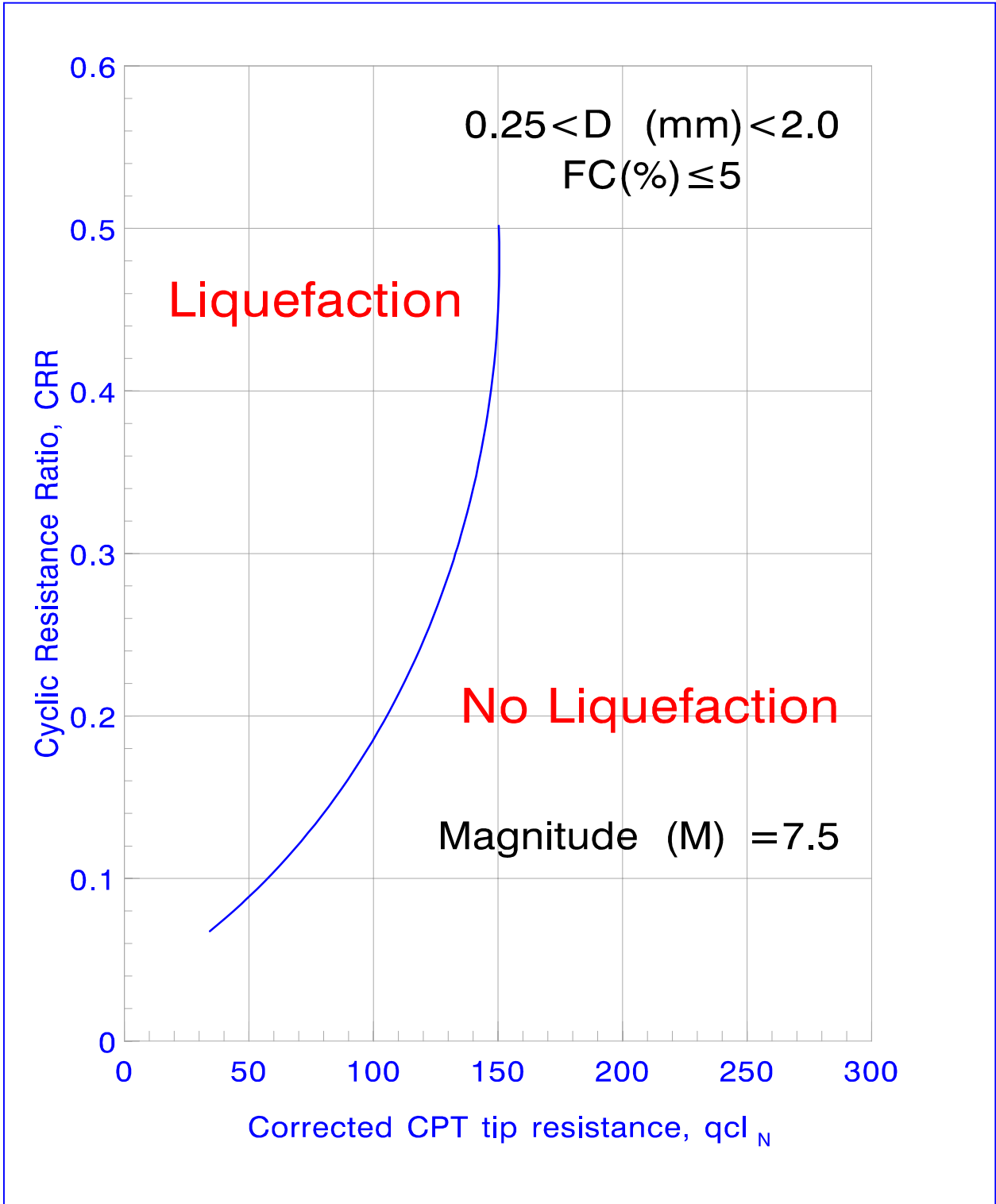

Figure 25
Cyclic Resistance Ratio (CRR) for Clean Sands
Under Level Ground Conditions Based on CPT

c) Correction for Fine Content. To correct for the materials with fines contents (FC) greater than 5 percent, the curve in Figure 26 can be used. To apply this correction, an increment of synthetic penetration resistance, Δq_{1cN} , or $\Delta(N_1)_{60}$, is added to the calculated normalized resistance q_{1cN} . This increment accounts for the combined influences of fines content on penetration resistance as a function of FC.

For $FC \geq 35\%$	$\Delta q_{1cN} = 60$	$\Delta(N_1)_{60} = 7.2$
For $FC \leq 5\%$	$\Delta q_{1cN} = 0$	$\Delta(N_1)_{60} = 0$
For $5\% < FC < 35\%$	$\Delta q_{1cN} = 2(FC - 5)$	$\Delta(N_1)_{60} = (1.2/5)(FC - 5)$

d) Correction for Different Earthquake Magnitudes. To adjust CRR to magnitudes other than 7.5, the calculated $CRR_{7.5}$ is multiplied by the magnitude scaling factor for the particular magnitude required. The same magnitude scaling factors are used with cone penetration data as for standard penetration data. Figure 27 can be used for the correction of different earthquake magnitudes.

e) Correction of CPT for Thin Soil Layers. This correction applies only to thin stiff layers embedded within thick soft layers. Figure 28 can be used to correct CPT data. The equation for evaluating the correction factor, K_c , is:

$$K_c = 0.5[(H/1,000) - 1.45]^2 + 1.0$$

where: H = thickness of the interbedded layer in mm.

For conservative correction use $q_{cA}/q_{cB} = 2$ (Soil Liquefaction and Its Evaluation Based on SPT and CPT, Robertson and Fear, 1996), where q_{cA} and q_{cB} are cone penetration resistances of the stiff and soft layers, respectively.

f) Plastic Fines. For soils with plastic fines, the so-called Chinese criteria should be applied for assessing liquefiability (Seed and Idriss, 1982). These criteria are that liquefaction can only occur if all three of the following conditions are met:

(1) Clay content (particle smaller than 5μ)
< 15 percent

(2) Liquid limit < 35 percent

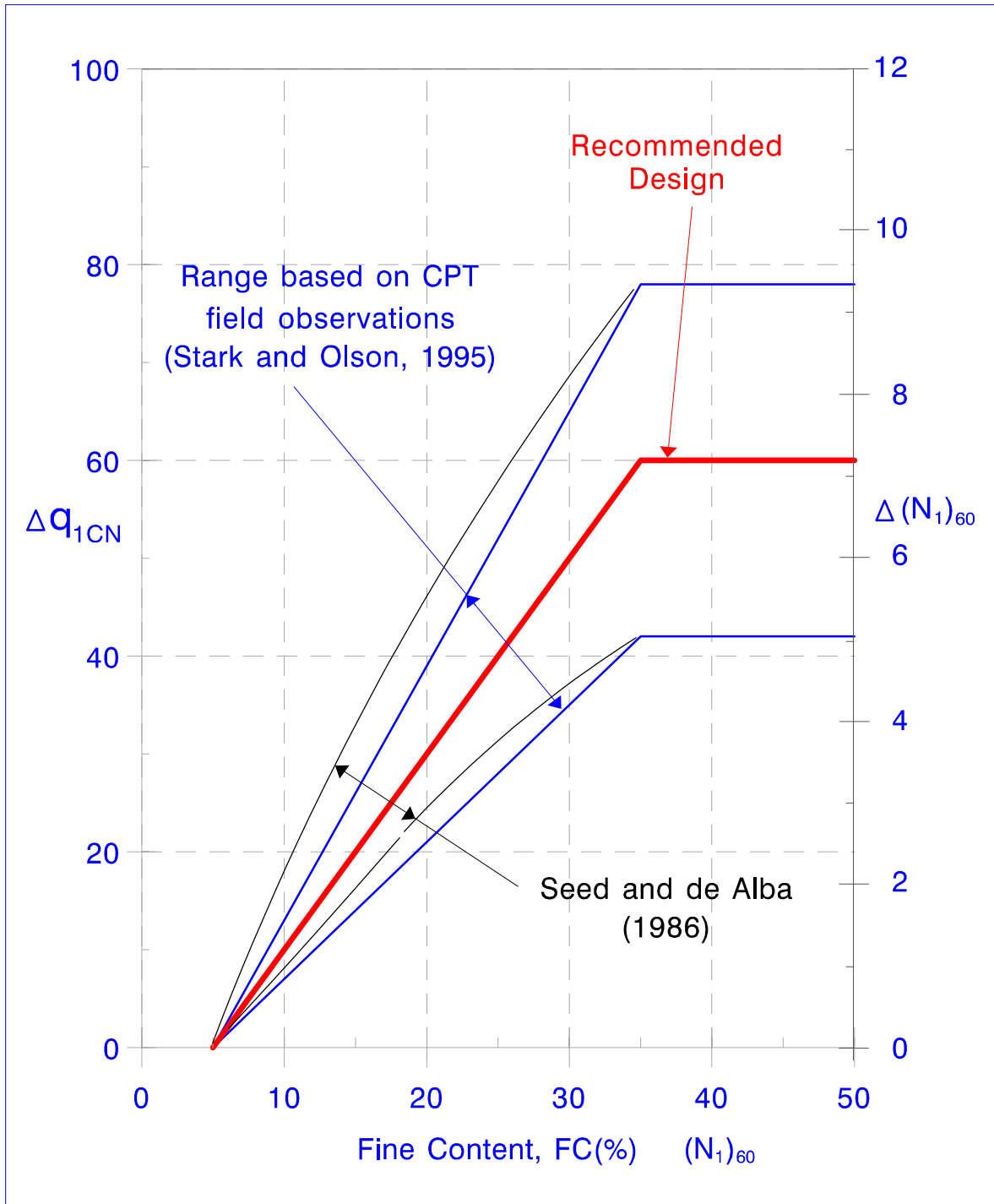

Figure 26
Correction to SPT and CPT Values for Fine Contents

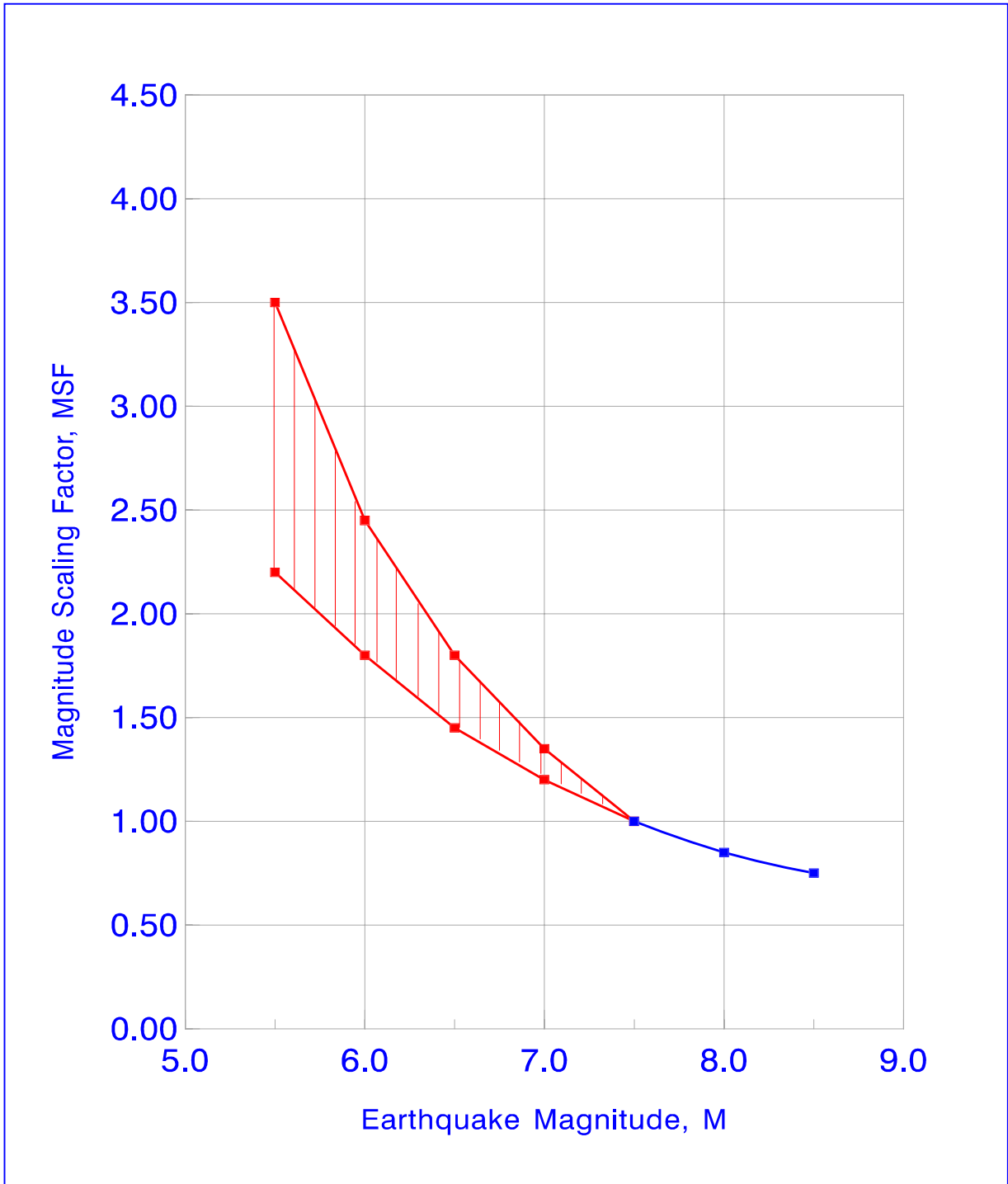

Figure 27
Range of Magnitude Scaling Factors for
Correction of Earthquake Magnitudes

c) Natural moisture content > 0.9 times the liquid limit

2.6.4 Peak Horizontal Acceleration. The maximum acceleration, a_{\max} , commonly used in liquefaction analysis is the peak horizontal acceleration that would occur at the site in the absence of liquefaction. Thus, the a_{\max} used in equation for CSR is the estimated rock-outcrop acceleration corrected for local soil response, but without consideration of excess pore-water pressures that might develop.

Methods commonly used to estimate a_{\max} include:

a) Estimates from standard peak acceleration attenuation curves valid for comparable soil conditions;

b) Estimates from standard peak acceleration attenuation curves for bedrock sites, with correction of a_{\max} for local site effects using standard site amplification curves, such as those given by Seed et al., or more preferably, using computerized site response analysis; and

c) From probabilistic maps of a_{\max} , with or without correction for site amplification or attenuation depending on the rock or soil conditions used to generate the maps.

A microcomputer program, named LIQUFAC, was developed by NAVFAC to evaluate the safety factor against liquefaction for each soil layer during an earthquake. It also estimates the associated dynamic settlement. The program is used in assessing the earthquake hazard to the Navy's sites located in seismic zone areas. An example output of this computer program is given in Appendix A.

Consult NAVFAC, Office of the Chief Engineer, for appropriate factors of safety for design of essential facilities. Use of the above procedure may be considered satisfactory for sand deposits up to 50 feet. For depths greater than 50 feet, it is recommended that this procedure be supplemented by laboratory tests and the site response method described below.

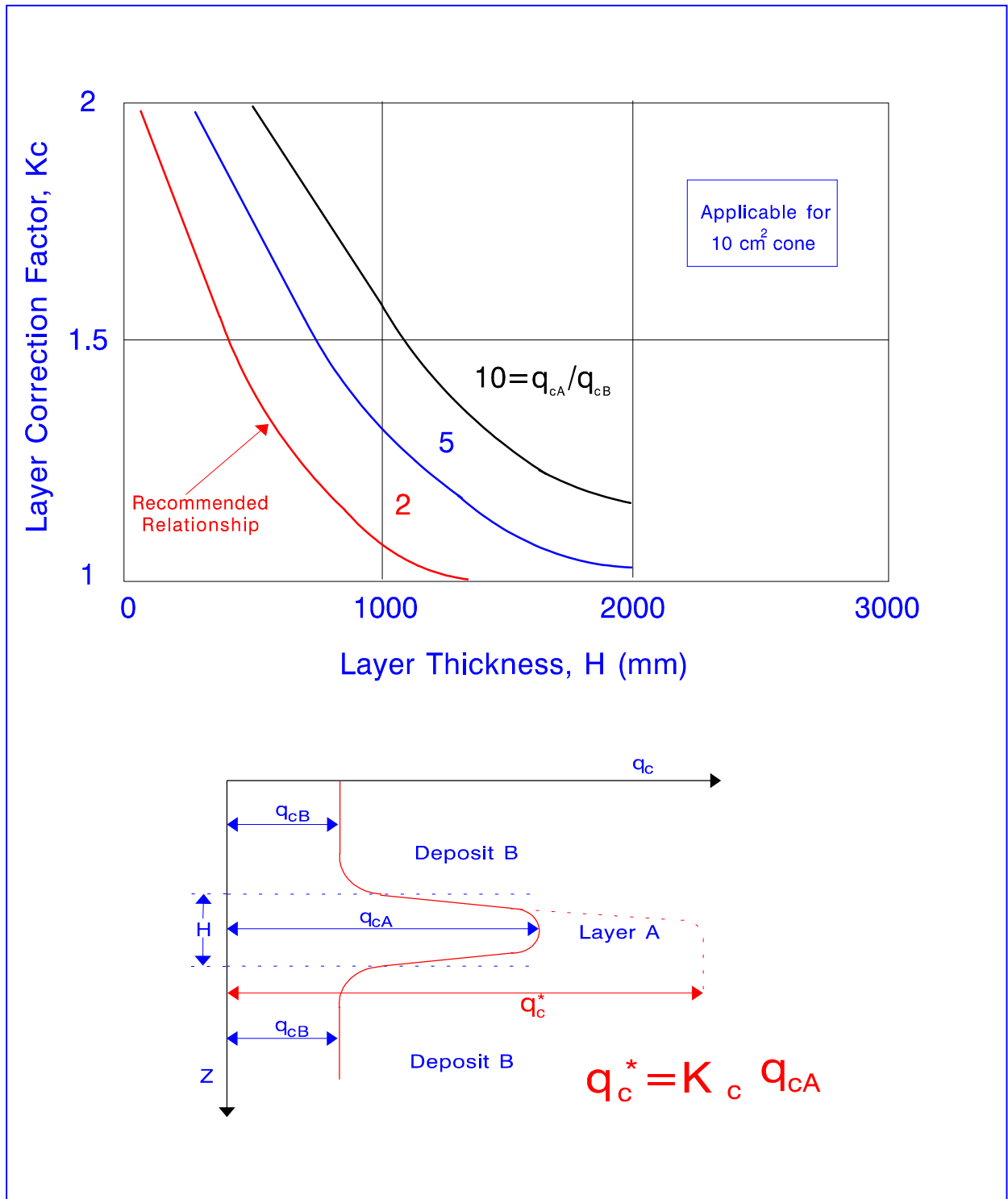

Figure 28
Correction (K_c) to CPT Penetration Resistance
in Thin Sand Layers

2.6.5 Laboratory Tests and Site Response Method. These procedures evaluate cyclic stress conditions likely to develop in the soil under a selected design earthquake and compare these stresses with those observed to cause liquefaction of representative samples in the laboratory (i.e., CRR). Laboratory test results should be corrected for the difference between laboratory and field conditions.

2.6.6 Slopes. Relatively few massive slope failures have occurred during earthquakes, but there have been some. On the other hand, many superficial (shallow) slides have been induced by seismic loads. The performance of earth slopes or embankments subjected to strong ground shaking is best measured in terms of deformation (Makdisi and Seed, 1978). Saturated loose to medium dense cohesionless soils are subject to liquefaction and these soils deserve special consideration in design. Sensitive clays also require special treatment.

2.6.6.1 Pseudostatic Design. Refer to NAVFAC DM-7.01, Chapter 7 for procedure. Pseudostatic design, including a lateral force acting through the center of gravity of the sliding mass continues to be used in practice today. Acceptable factors of safety against sliding generally range from 1.0 to 1.5 according to different codes and regulations. The most important and most difficult question in this type of analysis deals with the shear resistance of the soil. In many cases, the dynamic shear resistance of the soil are assumed equal to the static shear strength, prior to the earthquake. This would not be a conservative assumption for saturated loose to medium dense cohesionless soils. In cases of high embankments where failure may cause major damage or loss of life, the pseudostatic design should be verified by detailed dynamic analysis (Seed, et al, 1975). Another issue to be addressed in this type of design is the magnitude and location of the pseudostatic force. The current practice is to compute a weighted average of the amplified horizontal accelerations throughout the sliding mass and to apply it at the center of the mass. Vertical seismic forces are usually not applied along with the horizontal seismic forces.

2.6.6.2 Strain Potential Design. The strain which occurs in triaxial compression tests during undrained cyclic shear has also been used for analysis and design, especially for earth dams. The strain potential is only a measure of field

performance and is not assumed to represent permanent deformations. A two-dimensional finite element model is normally used to calculate seismic stress histories. These stresses are then simulated, as well as possible, using existing cyclic shear equipment in the laboratory.

2.6.7 Lateral Spreading from Liquefaction. Lateral deformation induced by earthquakes is discussed below.

2.6.7.1 Lateral Deformation. The occurrence of liquefaction and its associated loss of soil strength can cause large horizontal deformations. These deformations may cause failure of buildings, sever pipelines, buckle bridges, and topple retaining walls. The Navy sponsored research to develop procedures for quantification of lateral deformation (Youd, 1993).

Three types of ground failure are possible. Flow failures may occur on steep slopes. Lateral spread may occur on gentle slopes. The third type of failure involves ground oscillation on flat ground with liquefaction at depth decoupling surface layers. This decoupling allows rather large transient ground oscillation or ground waves.

2.6.7.2 Evaluation Procedure. Youd developed two independent models: a free-face model for areas near steep banks, and a ground-slope model for areas with gently sloping terrain. The equations are:

For the free-face model;

$$\begin{aligned} \text{Log } D_H = & -16.3658 + 1.178 M - 0.9275 \text{ Log } R - 0.0133 R \\ & +0.6572 \text{ Log } W + 0.3483 \text{ Log } T \\ & +4.5270 \text{ Log}(100-F_{15}) - 0.9224 D50_{15} \end{aligned}$$

For the ground slope model;

$$\begin{aligned} \text{Log } D_H = & -15.7870 + 1.1782 M - 0.9275 \text{ Log } R - 0.0133 R \\ & +0.4293 \text{ Log } S + 0.3483 \text{ Log } T_{15} \\ & +4.5270 \text{ Log}(100-F_{15}) - 0.9224 D50_{15} \end{aligned}$$

where: D_H = Estimated lateral ground displacement in meters.

$D50_{15}$ = Average mean grain size in granular layers

included in T_{15} , in millimeters

- F_{15} = Average fines content (fraction of sediment sample passing a No. 200 sieve) for granular layers included in T_{15} , in percent.
- M = Earthquake magnitude (moment magnitude).
- R = Horizontal distance from the seismic energy source, in kilometers.
- S = Ground slope, in percent.
- T_{15} = Cumulative thickness of saturated granular layers with corrected blow counts, $(N_1)_{60}$, less than 15, in meters.
- W = Ratio of the height (H) of the free face to the distance (L) from the base of the free face to the point in question, in percent.

To show the predictive performance of the above equations, Bartlett and Youd plotted predicted displacement against measured displacements recorded in the observational database and found that the equations correspond well with observation (Bartlett and Youd, 1992). The above two equations are generally valid for stiff soil sites in the Western U.S. or within 30 km of the seismic source in Japan, i.e., the localities from which the case history data were collected.

2.6.7.3 Application. Liquefaction of saturated granular soils and consequent ground deformation have been major causes of damage to constructed work during past earthquakes. Loss of bearing strength, differential settlement, and horizontal displacement due to lateral spread are the major types of ground deformation beneath level to gently sloping sites. This design guide provides procedures including equations, tables, and charts required to evaluate liquefaction susceptibility beneath level or gently sloping sites and to estimate probable free-field lateral displacement at those sites. Free-field ground displacements are those that are not impeded by structural resistance, ground modification, or a natural boundary.

These procedures may be used for assessment of

liquefaction-induced lateral ground displacements. The results may be used for preliminary assessment of ground-failure hazard to constructed or planned facilities, for initial lateral displacement design criteria (although structural impedance may prevent development of full free-field displacements), and for delineation of areas where liquefaction-induced earthquake damage might be expected.

A microcomputer program, named LATDER2, was developed to allow rapid computation of lateral spread resulting from liquefaction for a site. This program, with an example computation, is described in Appendix A.

2.7 FOUNDATION BASE ISOLATION

2.7.1 Seismic Isolation Systems. New technologies are becoming more prevalent in the seismic design of building structures. These technologies usually involve the use of special details or specific devices to alter or control the dynamic behavior of buildings. The technologies can be broadly categorized as passive, active, or hybrid control systems.

Candidate structures for base isolation should meet the following criteria:

- a) The site be located in a zone of high seismic hazard.
- b) The structure not be founded on soft soil.
- c) The building be low to medium height.
- d) The building have a relatively low shape factor($H/L \leq 1$).
- e) The contents of the building be sensitive to high frequency vibration.
- f) The lateral load resisting system make the building a rigid structure.

2.7.2 System Definitions. Generally there are three types of seismic control systems: passive control systems, active control systems, and hybrid control systems.

2.7.2.1 Passive Control Systems. These systems are designed to dissipate a large portion of the earthquake input energy in specialized devices or special connection details which deform or yield during an earthquake. These systems are passive in that they do not require any additional energy source to operate and are activated by the earthquake input motion. Seismic isolation and passive energy dissipation are both examples of passive control systems.

2.7.2.2 Active Control Systems. These systems provide seismic protection by imposing forces on a structure that counterbalance the earthquake induced forces. These systems are active in that

they require an energy source and computer-controlled actuators to operate special braces of tuned-mass dampers located throughout the building. Active systems are more complex than passive systems since they rely on computer control, motion sensors, feedback mechanisms, and moving parts which may require service or maintenance. These systems need an emergency power source to ensure that they will be operable during a major earthquake and any immediate aftershocks.

2.7.2.3 Hybrid Control Systems. These systems combine features of both passive and active control systems. In general, they have reduced power demands, improved reliability, and reduced cost when compared to fully active systems.

2.7.3 Mechanical Engineering Applications. It is important to note that the passive energy dissipation systems described here are "new" technologies when applied to civil engineering structures, but they have been used in mechanical engineering applications for many years. There are numerous situations where dampers, springs, torsion bars, or elastomeric bearings have been used to control vibration or alter the dynamic behavior of mechanical systems. Several examples include vehicular shock absorbers or spring mounts that provide vertical vibration isolation for military hardware.

2.7.4 Historical Overview of Building Applications. Several types of isolation and supplemental damping systems have previously been used in building structures to solve problems related to vertical vibrations or wind loading. For example, the World Trade Center Towers in New York City were built with a system of viscoelastic dampers to alleviate human discomfort due to wind loading. The use of passive energy dissipation systems for seismic design is a relatively recent development, although there are now examples of these systems throughout the world. Base isolation is an expensive way to mitigate the effects of earthquake. Therefore, it has not been used widely for new construction. However, it has been used effectively in cases of important older structures, that have not been adequately designed to resist earthquakes. Putting base isolation under the building can conserve the architecture and protect the building.

2.7.5 Design Concept. The design of a seismic isolation system depends on many factors including the period of the

fixed-base structure, the period of the isolated structure, the dynamic characteristics of the soil at the site, the shape of the input response spectrum, and the force-deformation relationship for the particular isolation device. The primary objective of the design is to obtain a structure such that the isolated periods of the building are sufficiently longer than both the fixed-base periods of the building, i.e., the period of the superstructure, and the predominant period of the soil at the site. In this way, the superstructure can be decoupled from the maximum earthquake input energy. The spectral accelerations at the isolated period of the building are significantly reduced from those at the fixed-base period. The resultant forces on structural and nonstructural elements of the superstructure will be significantly reduced when compared with conventional fixed-base construction.

2.7.6 Device Description. A number of seismic isolation devices are currently in use or proposed for use in the United States. Although the specific properties vary, they are all designed to support vertical dead loads and to undergo large lateral deformation during a major earthquake. Some of these systems use elastomeric bearings; others use sliding systems which rely on frictional resistance. A number of these systems are listed below along with the vendor name of patented systems.

2.7.6.1 Elastometer Systems

- a) High-damping rubber bearing (HDR), non-proprietary
- b) Lead rubber bearing (LRB), DIS

2.7.6.2 Sliding System

- a) Earthquake Barrier System(EBS), M.S. Caspe
- b) Friction-Pendulum System (FPS), EPS
- c) Resilient frictional base isolation (RFBI),
N. Mostaghel

2.7.6.3 Hybrid Systems

- a) Combined Rubber-Slider-Restainer System, Fyfe Associates

- b) Zoltan Isolator, Lorant Group
- c) GERB Steel Springs, GERB

2.7.6.4 Applications. While base isolation is an excellent solution for some building structures, it may be entirely inappropriate for others. Since the objective of isolation design is to separate the response of the fixed-base structure from the predominant period of the underlying soil, it is most effective when these two periods coincide. In cases where they are already widely separated, base isolation may increase the response of the structure rather than reduce it. For instance, a very stiff structure on very soft soil would be a poor candidate, as would a very soft structure on very stiff soil. The damping of the isolation device may serve to further reduce the response of the building. However, for the sake of simplicity, the effect of damping is not included in the following examples.

2.7.7 Examples of Applications. Base isolated structures require lighter structural members than nonisolated structures. In addition, nonstructural components (utilities, partitions, parapets, suspended ceiling, equipments, etc.) are less likely to be damaged in a base isolated structure. Isolation from ground motion is produced by the low horizontal stiffness of the bearings. This substantially reduces the frequency of the predominant horizontal mode of the structure vibration, typically lower than 1.0 hertz. Most earthquake ground motions have predominant frequencies in the 3 to 10 hertz range and are, therefore, effectively filtered by the isolation system, allowing only relatively small accelerations to be imported to the structure. The general principles are illustrated in Figure 29 and Figure 30 from Vaidya et al. (NCEL N-1827, An Analysis of Base Isolation Design Issues for Navy Essential Construction, 1991), (Vaidya, 1988).

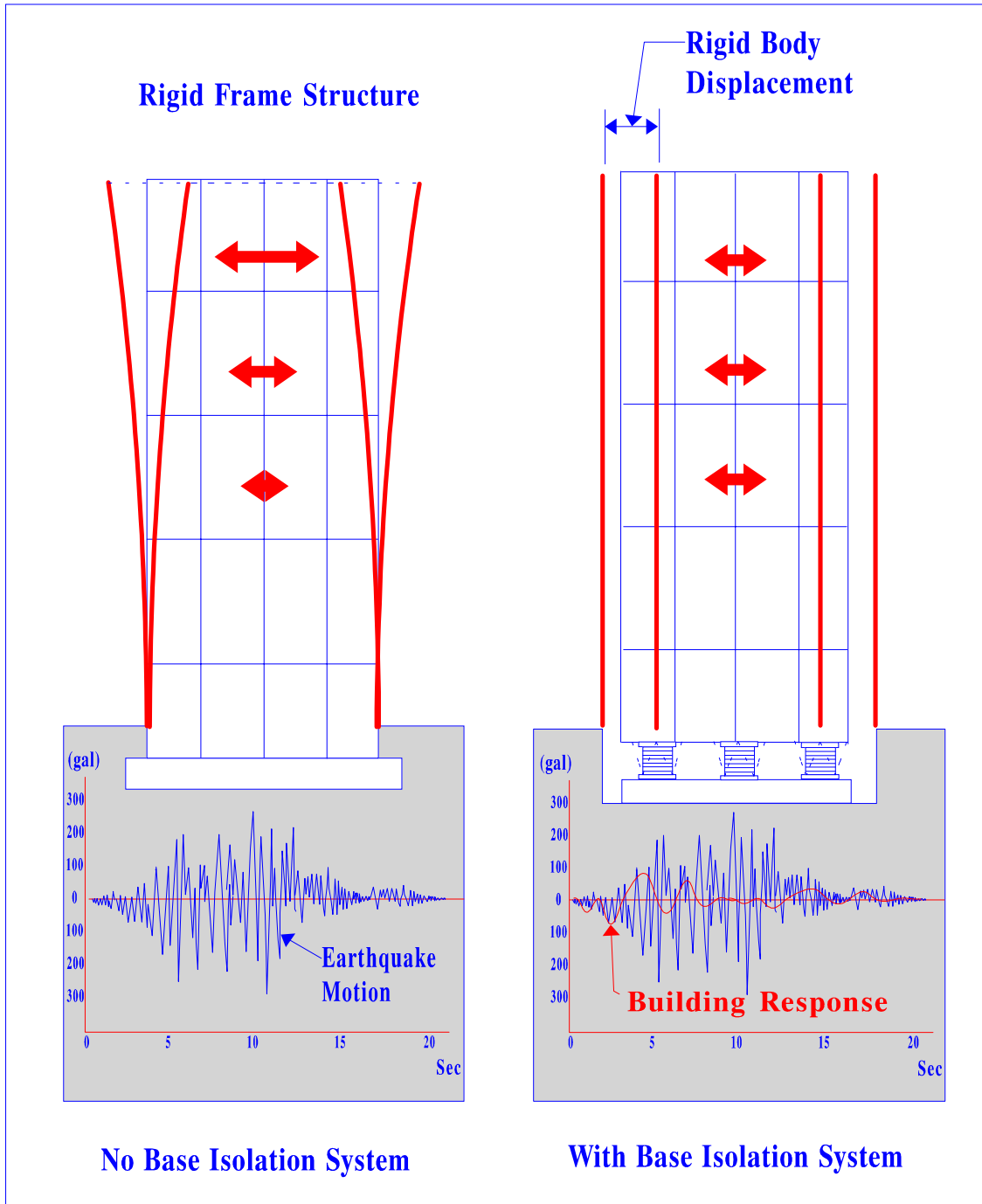

Figure 29
The Base Isolation System

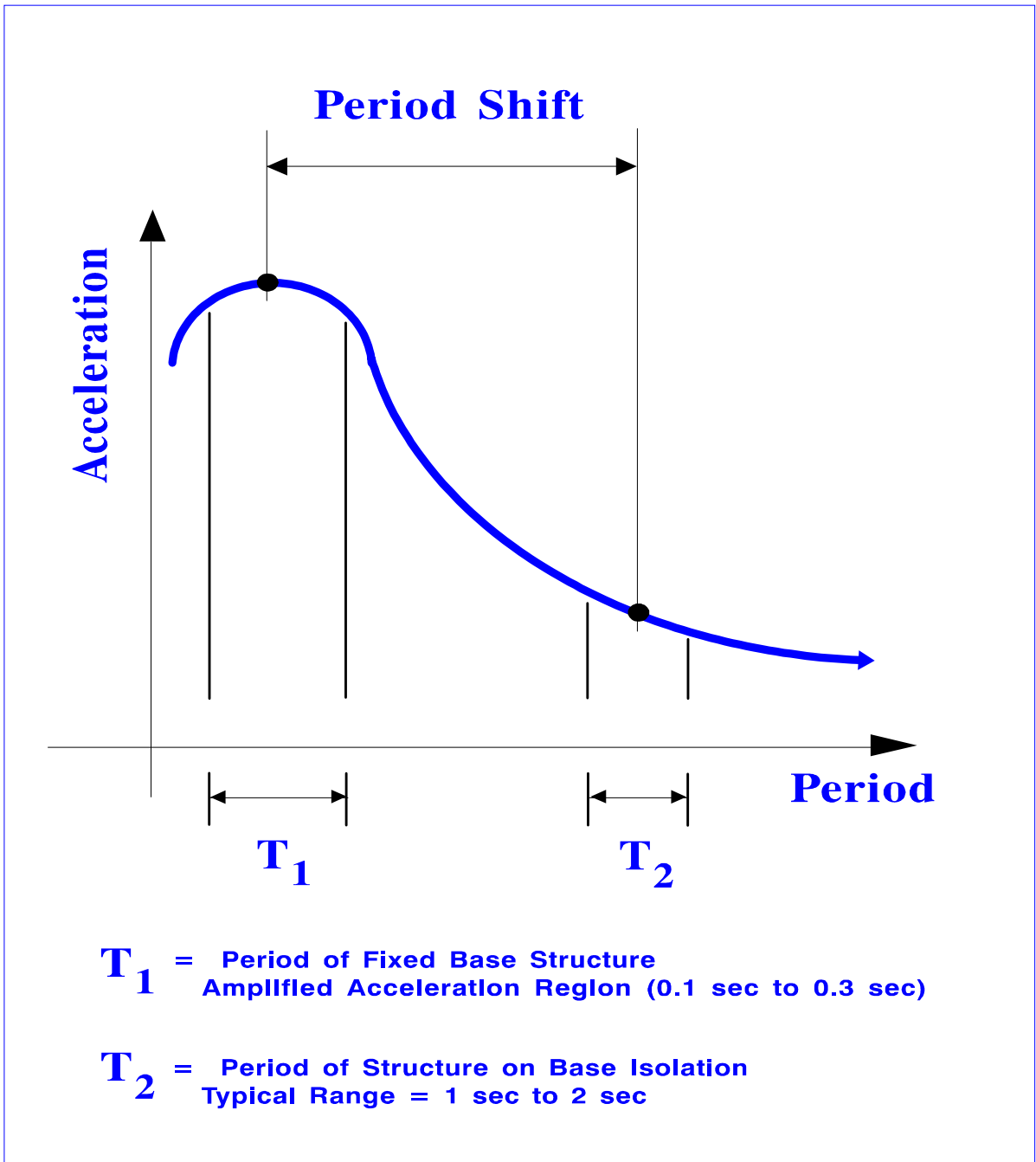

Figure 30
The Acceleration Spectrum Showing Period Shift

Section 3: SPECIAL DESIGN ASPECTS

3.1 SEISMIC DESIGN OF ANCHORED SHEET PILE WALLS

3.1.1 Design of Sheet Pile Walls for Earthquake. The design of anchored sheet pile walls subjected to seismic loading may use the free earth support method. Figure 31 shows the measured distribution of bending moment in three model tests on anchored bulkheads. The design methods and an example computation are given below.

3.1.2 Design Procedures. The design procedures are described by 10 steps (NCEL TR-939, The Seismic Design of Waterfront Retaining Structures, Ebeling and Morrison, 1992).

a) Step 1: Evaluate potential for liquefaction or excessive deformation of the structure.

b) Step 2: Perform static design. Provide initial depth of penetration required using the free earth support method.

c) Step 3: Determine the average site specific acceleration for wall design.

d) Step 4: Compute dynamic earth pressure forces and water pressure forces. (Refer to NAVFAC DM-7.02, Earthquake Loading, Chapter 3, Analysis of Walls and Retaining Structures.)

e) Step 5: Sum the moments due to the driving forces and the resisting forces about the tie rod elevation.

f) Step 6: Alter the depth of penetration and repeat steps 4 and 5 until moment equilibrium is achieved. The minimum depth of embedment has been computed when moment equilibrium is satisfied.

g) Sum horizontal forces to compute the tie rod force (per foot of wall).

h) Compute the maximum bending moment, apply Rowe's moment reduction factor (NAVFAC DM-7.02) and size the flexible wall (if applicable).

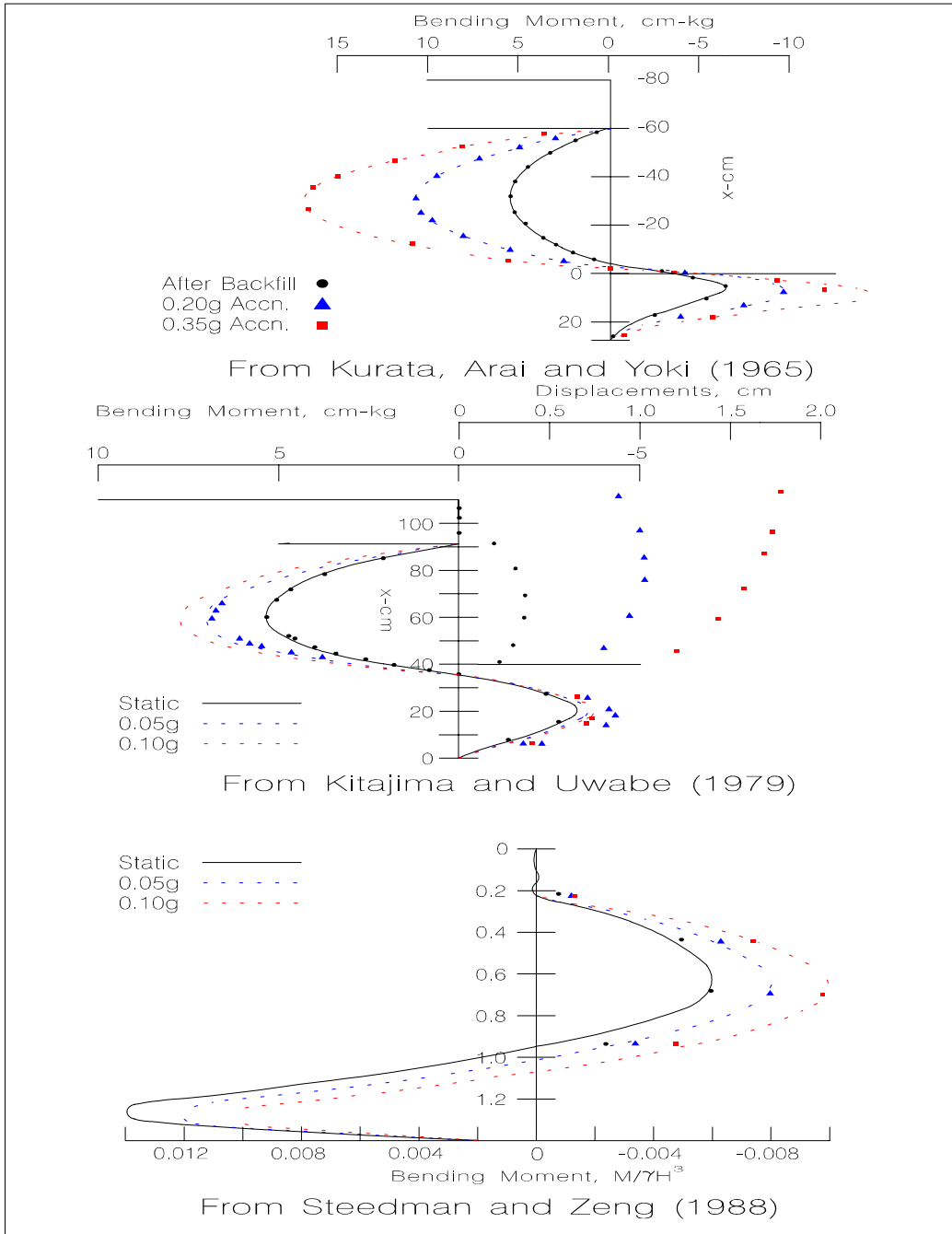

Figure 31
 Measured Distributions of Bending Moment
 in Three Model Tests on Anchored Bulkhead

j) Step 10: Design and site the anchorage. The anchor should be located far enough from the wall such that the active wedge from the wall (starting at the bottom of the wall) and the passive wedge from the anchor do not intersect.

3.1.3 Example Computation. An example computation of anchored sheet pile wall subjected to seismic load is given in Figure 32. The example computation follows 10 steps described by the above design procedures.

a) This example assumes that the results of a liquefaction analysis (refer to Section 13 of this handbook) indicate the site will not liquefy under the design earthquake load.

b) From the static loading design, the computation indicates the depth of sheet pile penetration, D , requires 10.02 ft. For seismic loading, a larger D value is needed. For the first trial computation, use $D = 20$ ft.

c) For seismic coefficients, assume horizontal seismic coefficient $K_h = 0.2$, and vertical seismic coefficient $K_v = 0.1$.

d) Dynamic active earth pressure, P_{ae} .

$$P_{ae} = K_{ae}(\frac{1}{2})[\gamma_e(1-K_v)]H^2 = 46,160 \text{ lb/ft}$$

$$(P_{aex} = P_{ae}(\cos\delta) = 44,020 \text{ lb/ft per foot of wall}$$

Hydrodynamic water pressure force, P_{wd} .

$$P_{wd} = (7/12)K_h \gamma_w(H_w)^2 = 2912 \text{ lb/ft}$$

e) Compute unbalanced moment about the elevation of the tie rod, M_b .

$$M_b = -153,400 \text{ lb-ft}$$

Too large for M_b value (M_b value should approach zero).

f) Reduce sheet pile embedment length and recompute unbalanced moment M_b . In this example, for $D = 16$ ft, the moment equilibrium is satisfied.

g) Compute tie rod force, T .

$$T = P_{aa} + \Delta P_{aex} + P_{wd} = 31,730 \text{ lb/ft}$$

h) Compute design moment, M_{allow} .

$$\begin{aligned} M_{allow} &= S(0.9)\sigma_{yield} = 30.2(9)(36000) \text{ lb/in}^2 \\ &= 140,900,000 \text{ lb/ft}^2 \end{aligned}$$

i) Design tie rods. Assume tie rod spacing is 6 ft.

$$T_{design} = 1.3 T = 1.3(31,730) = 41,250 \text{ lb/ft}$$

$$A = 6 T_{design} / \sigma_{allow} = 0.053 \text{ ft}^2 = 7.63 \text{ in}^2$$

$$d = [4 A / \pi]^{1/2} = 3.12 \text{ inches}$$

j) Design of anchorage. See anchorage system discussed below.

3.1.4 Anchorage System. Most of the difficulties with anchored bulkheads are caused by their anchorage. A tieback may be carried to a buried deadman anchorage, to pile anchorage, parallel wall anchorage, or it may be a drilled and grouted ground anchor. For a deadman anchorage, refer to NAVFAC DM-7.02, Chapter 3, Section 4, Figure 20, Design Criteria for Deadman Anchorage.

3.1.5 Ground Anchors. There are two types of anchors: (1) soil anchors, and (2) rock anchors. Ground anchors transfer load from tendon to grout then from grout to soil or rock. Load transfer is by either friction along a straight shaft or by bearing against an underreamed bell or both. Figure 33 shows basic components of ground anchors. Figure 34 shows estimate of anchor capacity which provides empirical ultimate capacity of anchors in granular soils. Table 7 provides types of soil anchors.

Anchored Bulkhead Design

Subject Seismic Loadings

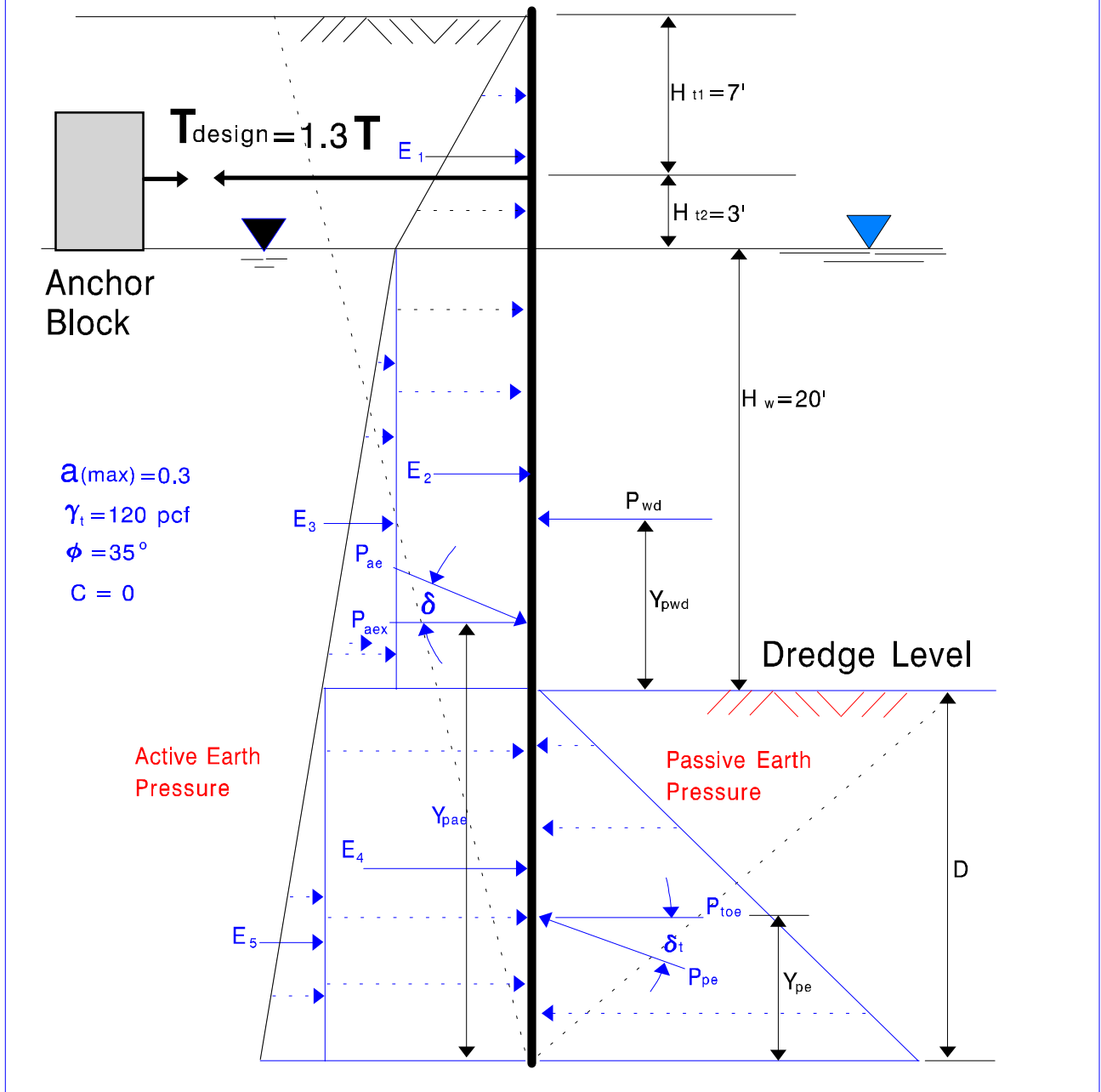

Figure 32
Example of Anchored Sheet Pile Wall Design

MIL-HDBK-1007/3

1. Check Site Liquefaction Potential

Use LIQUFAC computer program to compute liquefaction potential analysis. Densify the soils behind the sheet pile if liquefaction will occur at the design earthquake load.

2. From static design, calculate depth of sheet pile penetration below dredge level, D.

$$\text{From } \sum M_T = 0 \quad \sum E_i d_i - P_{toe} d_{toe} = 0 \quad \text{Obtain } D = 10.02 \text{ ft.}$$

3. Determine Horizontal and Vertical Seismic Coefficients

Consider average peak ground acceleration $a(\text{max}) := 0.3$
 Assume displacement is less than 1.0 inch

$$K_h := \frac{2}{3} \cdot a(\text{max}) \quad K_h = 0.2 \quad K_v := 0.1 \quad (K_v = 0.1, 0, \text{ or } -0.1)$$

Equivalent horizontal seismic coefficient for the backfill

$$\gamma_t := 120 \cdot \text{lb} \cdot \text{ft}^{-3} \quad \gamma_w := 62.4 \frac{\text{lb}}{\text{ft}^3} \quad \gamma_b := \gamma_t - \gamma_w$$

$$\gamma_b = 57.6 \text{ lb} \cdot \text{ft}^{-3}$$

$$\gamma_e := \left(\gamma_t - 62.4 \cdot \frac{\text{lb}}{\text{ft}^3} \right) \cdot 1.4 \quad \gamma_e = 80.64 \text{ lb} \cdot \text{ft}^{-3} \quad K_{he} := \frac{\gamma_t}{\gamma_e} \cdot K_h \quad K_{he} = 0.298$$

Seismic inertia angle for soils

$$\psi := \text{atan} \left(\frac{K_{he}}{1 - K_v} \right) \quad \psi = 18.298 \text{ deg}$$

4. Determine Dynamic Pressure

Dynamic active earth pressure

$$\phi := 35 \text{ deg} \quad \delta := \frac{\phi}{2} \quad \delta := 17.5 \text{ deg}$$

$$K_{ae} := \frac{\cos(\phi - \psi)^2}{\cos(\psi) \cdot \cos(\psi + \delta) \cdot \left(1 + \sqrt{\frac{\sin(\phi + \delta) \cdot \sin(\phi - \psi)}{\cos(\delta + \psi)}} \right)^2} \quad K_{ae} = 0.509$$

$$H_{t1} := 7 \text{ ft} \quad H_{t2} := 3 \text{ ft} \quad H_w := 20 \text{ ft}$$

D=10.24 ft was found not be stable under earthquake loading.
 Use D:=20.24ft in this computation

$$H := H_{t1} + H_{t2} + H_w + D \quad H = 50.24 \text{ ft}$$

$$P_{ae} := K_{ae} \cdot \frac{1}{2} \cdot (\gamma_e \cdot (1 - K_v)) \cdot H^2 \quad P_{ae} = 4.66 \cdot 10^4 \cdot \text{lb} \cdot \text{ft}^{-1}$$

$$P_{aex} := P_{ae} \cdot \cos(\delta) \quad P_{aex} = 4.445 \cdot 10^4 \cdot \text{lb} \cdot \text{ft}^{-1} \quad \text{per foot of wall}$$

Figure 32 (Continued)
 Example of Anchored Sheet Pile Wall Design

Horizontal static active earth pressure component of P_{ae}

$$\theta := 0 \text{ deg} \quad \beta := 0 \text{ deg}$$

$$K_{ap} := \frac{\cos(\phi - \theta)^2}{\cos(\theta)^2 \cdot \cos(\theta + \delta) \cdot \left(1 + \frac{\sin(\phi + \delta) \cdot \sin(\theta - \beta)}{\sqrt{\cos(\delta + \theta) \cdot \cos(\beta - \theta)}} \right)^2}$$

$$K_{ap} = 0.704$$

$$\cos(\delta) = 0.954$$

$$K_{ap} \cdot \cos(\delta) = 0.671$$

Horizontal ForceDistance to Pile Tip

$$E1 := K_{ap} \cdot \cos(\delta) \cdot \frac{1}{2} \cdot \gamma t \cdot (Ht1 + Ht2)^2$$

$$E1 = 4.026 \cdot 10^3 \cdot \text{lb} \cdot \text{ft}^{-1}$$

$$d1 := \frac{1}{3} \cdot (Ht1 + Ht2) + Hw + D$$

$$d1 = 43.573 \text{ ft}$$

$$E2 := K_{ap} \cdot \cos(\delta) \cdot \frac{1}{2} \cdot \gamma t \cdot (Ht1 + Ht2) \cdot Hw$$

$$E2 = 8.052 \cdot 10^3 \cdot \text{lb} \cdot \text{ft}^{-1}$$

$$d2 := \frac{1}{2} \cdot Hw + D$$

$$d2 = 30.24 \text{ ft}$$

$$E3 := K_{ap} \cdot \cos(\delta) \cdot \frac{1}{2} \cdot \gamma b \cdot Hw^2$$

$$E3 = 7.73 \cdot 10^3 \cdot \text{lb} \cdot \text{ft}^{-1}$$

$$d3 := \frac{1}{3} \cdot Hw + D$$

$$d3 = 26.907 \text{ ft}$$

$$E4 := K_{ap} \cdot \cos(\delta) \cdot (\gamma t \cdot (Ht1 + Ht2) + \gamma b \cdot Hw) \cdot D$$

$$E4 = 3.194 \cdot 10^4 \cdot \text{lb} \cdot \text{ft}^{-1}$$

$$d4 := \frac{1}{2} \cdot D$$

$$d4 = 10.12 \text{ ft}$$

$$E5 := K_{ap} \cdot \cos(\delta) \cdot \frac{1}{2} \cdot \gamma b \cdot D^2$$

$$E5 = 7.917 \cdot 10^3 \cdot \text{lb} \cdot \text{ft}^{-1}$$

$$d5 := \frac{1}{3} \cdot D$$

$$d5 = 6.747 \text{ ft}$$

$$P_{toe} := K_{ap} \cdot \cos(\delta) \cdot \frac{1}{2} \cdot \gamma b \cdot D^2$$

$$P_{toe} = 7.917 \cdot 10^3 \cdot \text{lb} \cdot \text{ft}^{-1}$$

$$d_{toe} := Ht2 + Hw + \frac{2}{3} \cdot D$$

$$d_{toe} = 36.493 \text{ ft}$$

$$P_{ax} := E1 + E2 + E3 + E4 + E5$$

$$P_{ax} = 5.967 \cdot 10^4 \cdot \text{lb} \cdot \text{ft}^{-1}$$

$$Y_{pa} := \frac{E1 \cdot d1 + E2 \cdot d2 + E3 \cdot d3 + E4 \cdot d4 + E5 \cdot d5}{E1 + E2 + E3 + E4 + E5}$$

$$Y_{pa} = 16.82 \text{ ft}$$

Figure 32 (Continued)
Example of Anchored Sheet Pile Wall Design

MIL-HDBK-1007/3

Horizontal component of the incremental dynamic active earth pressure force

$$\Delta Paex := Paex - Pax \qquad \Delta Paex = -1.522 \cdot 10^4 \cdot \text{lb} \cdot \text{ft}^{-1}$$

$$Y\Delta Paex := 0.6 \cdot H \qquad Y\Delta Paex = 30.144 \text{ ft}$$

$$Y_{pae} := \frac{Pax \cdot Y_{pa} + \Delta Paex \cdot Y\Delta Paex}{Paex} \qquad Y_{pae} := 23.78 \cdot \text{ft}$$

Equivalent horizontal seismic coefficient used in front of wall

$$K_{hew} := \frac{\gamma t}{\gamma b} \cdot K_h \qquad K_{hew} = 0.417$$

Seismic inertia angle used in front of wall

$$\psi_{ew} := \text{atan} \left(\frac{K_{hew}}{1 - K_v} \right) \qquad \psi_{ew} = 24.842 \cdot \text{deg}$$

Horizontal dynamic passive earth pressure force, Ppe

$$\phi_e := 30.3 \text{ deg} \qquad \delta t := 14.7 \text{ deg} \qquad \psi := 24.84 \text{ deg}$$

$$K_{pe} := \frac{\cos(\phi_e - \psi)^2}{\cos(\psi) \cdot \cos(\psi + \delta t) \cdot \left[1 - \left(\frac{\sin(\phi_e + \delta t) \cdot \sin(\phi_e - \psi)}{\cos(\delta t + \psi)} \right)^2 \right]}$$

$$K_{pe} = 2.852$$

$$P_{pex} := K_{pe} \cdot \cos(\delta t) \cdot \frac{1}{2} \cdot (\gamma b \cdot (1 - K_v)) \cdot D^2 \qquad P_{pex} = 2.929 \cdot 10^4 \cdot \text{lb} \cdot \text{ft}^{-1}$$

$$Y_{pe} := \frac{1}{3} \cdot D \qquad Y_{pe} = 6.747 \text{ ft}$$

Hydrodynamic water pressure force, Pwd

$$\gamma_w := 62.4 \cdot \text{lb} \cdot \text{ft}^{-3}$$

$$P_{wd} := \frac{7}{12} \cdot K_h \cdot \gamma_w \cdot H_w^2 \qquad P_{wd} = 2.912 \cdot 10^3 \cdot \text{lb} \cdot \text{ft}^{-1}$$

$$Y_{pwd} := 0.4 \cdot H_w \qquad Y_{pwd} = 8 \cdot \text{ft}$$

Figure 32 (Continued)
Example of Anchored Sheet Pile Wall Design

5. Compute Moments about the Elevation of the Tie Rod

$$D = 20.24 \text{ ft} \quad Y_{pae} := 23.87 \text{ ft} \quad b := 1 \cdot \text{ft}$$

$$M_{ccw} := P_{aex} \cdot (Ht2 + Hw + D - Y_{pae}) \cdot b + P_{wd} \cdot (Ht2 + Hw - 0.4Hw) \cdot b$$

$$M_{ccw} = 9.046 \cdot 10^5 \cdot \text{lb} \cdot \text{ft}$$

$$M_{cw} := -P_{pex} \cdot (Ht2 + Hw + D - Y_{pe}) \cdot b \quad M_{cw} = -1.069 \cdot 10^6 \cdot \text{lb} \cdot \text{ft}$$

$$\text{Unbalance moment} \quad M_b := M_{ccw} + M_{cw} \quad M_b = -1.644 \cdot 10^5 \cdot \text{lb} \cdot \text{ft}$$

Too large, reduce D value

6. Alter the Depth, D, until Equilibrium is Satisfied

$$\text{For } D=15 \text{ ft} \quad M_b=16,620 \text{ lb} \cdot \text{ft} \quad \text{Use } D=16 \text{ ft}$$

$$D := 16 \text{ ft} \quad \Delta P_{aex} := -12750 \cdot \frac{\text{lb}}{\text{ft}} \quad P_{ax} := 50010 \cdot \frac{\text{lb}}{\text{ft}}$$

7. Compute Tie Rod Force

$$T := P_{aex} + P_{wd} - P_{pex} \quad T = 1.807 \cdot 10^4 \cdot \text{lb} \cdot \text{ft}^{-1}$$

8. Compute Maximum Moment

$$y := 15.32 \cdot \text{ft} \quad \sigma_t := 1.6 \left(\frac{\Delta P_{aex}}{H} \right) \quad \sigma_y := 559.2 \text{ lb} \cdot \text{ft}^{-2} - 9.8 \text{ lb} \cdot \text{ft}^{-3} \cdot y$$

$$\Delta P_{aex} := \frac{1}{2} \cdot (\sigma_t + \sigma_y) \cdot (10 \cdot \text{ft} + y) \quad \Delta P_{aex} = 38.145 \text{ lb} \cdot \text{ft}^{-1}$$

$$P_{wd} := \frac{7}{12} \cdot K_h \cdot \gamma \cdot w \cdot y^2$$

$$T := P_{ax} + \Delta P_{aex} + P_{wd}$$

$$T = 5.176 \cdot 10^4 \cdot \text{lb} \cdot \text{ft}^{-1}$$

Moment of force acting above $y=15.32$ ft below the water table, and the force act about the Tie Rod

Figure 32 (Continued)
Example of Anchored Sheet Pile Wall Design

Horizontal Force

Lever Arm

$$E1 = 4.026 \cdot 10^3 \cdot \text{lb} \cdot \text{ft}^{-1}$$

$$d1t := \text{Ht2} - \frac{1}{3} \cdot (\text{Ht1} + \text{Ht2})$$

$$d1t = -0.333 \text{ ft}$$

$$E2x := \text{Kap} \cdot \cos(\delta) \cdot \gamma \cdot t \cdot (\text{Ht1} + \text{Ht2}) \cdot y$$

$$d2t := \text{Ht2} + \frac{1}{2} \cdot y$$

$$E2x = 1.234 \cdot 10^4 \cdot \text{lb} \cdot \text{ft}^{-1}$$

$$d2t = 10.66 \text{ ft}$$

$$E3x := \text{Kap} \cdot \cos(\delta) \cdot \frac{1}{2} \cdot \gamma \cdot b \cdot y^2$$

$$d3t := \text{Ht2} + \frac{2}{3} \cdot y$$

$$E3x = 4.536 \cdot 10^3 \cdot \text{lb} \cdot \text{ft}^{-1}$$

$$d3t = 13.213 \text{ ft}$$

$$\Delta \text{Paex} := 13499 \text{ lb} \cdot \text{ft}^{-1}$$

$$\Delta \text{Paex} = 13499 \text{ lb} \cdot \text{ft}^{-1}$$

$$\text{Pwd} := 1709 \text{ lb} \cdot \text{ft}^{-1}$$

$$dwt := \text{Ht2} + 0.6 \cdot y$$

$$dwt = 12.192 \text{ ft}$$

$$dwt = 12.192 \quad \text{ft}$$

$$Mf = 2.741 \cdot 10^5 \cdot \text{lb} \cdot \text{ft}$$

9. Compute Design Moment

$$d3t := \text{Ht2} + \frac{2}{3} \cdot y$$

$$\sigma_{\text{allow}} := 0.9 \cdot \sigma_{\text{yield}}$$

Section S (sec. modulus)

$$E3x := \text{Kap} \cdot \cos(\delta) \cdot \frac{1}{2} \cdot \gamma \cdot b \cdot y^2$$

PZ22 18.1 in³

PZ27 30.2

$$S := 30.2 \text{ in}^3 \quad \text{Use PZ27}$$

PZ35 48.5

PZ40 60.7

$$M_{\text{allow}} := S \cdot \sigma_{\text{allow}} \quad M_{\text{allow}} = 1.526 \cdot 10^8 \cdot \text{lb} \cdot \text{ft}^{-2}$$

10. Design Tie Rods

$$T_{\text{design}} := 1.3 \cdot T \quad T_{\text{design}} = 6.728 \cdot 10^4 \cdot \text{lb} \cdot \text{ft}^{-1}$$

Assume 6 ft spacing to compute minimum area of rod $Sp := 6 \text{ ft}$

$$A := \frac{Sp \cdot T_{\text{design}}}{\sigma_{\text{allow}}} \quad A = 0.08 \text{ ft}^2$$

$$d := \sqrt{4 \cdot \frac{A}{\pi}} \quad d = 3.827 \text{ in}$$

11. Design of Anchorage System

Refer to paragraph 3.1.4 entitled "Anchorage System" of this handbook and/or NAVFAC DM 7.02, Chapter 3, Section 3, "Rigid Retaining Walls"

Figure 32 (Continued)
Example of Anchored Sheet Pile Wall Design

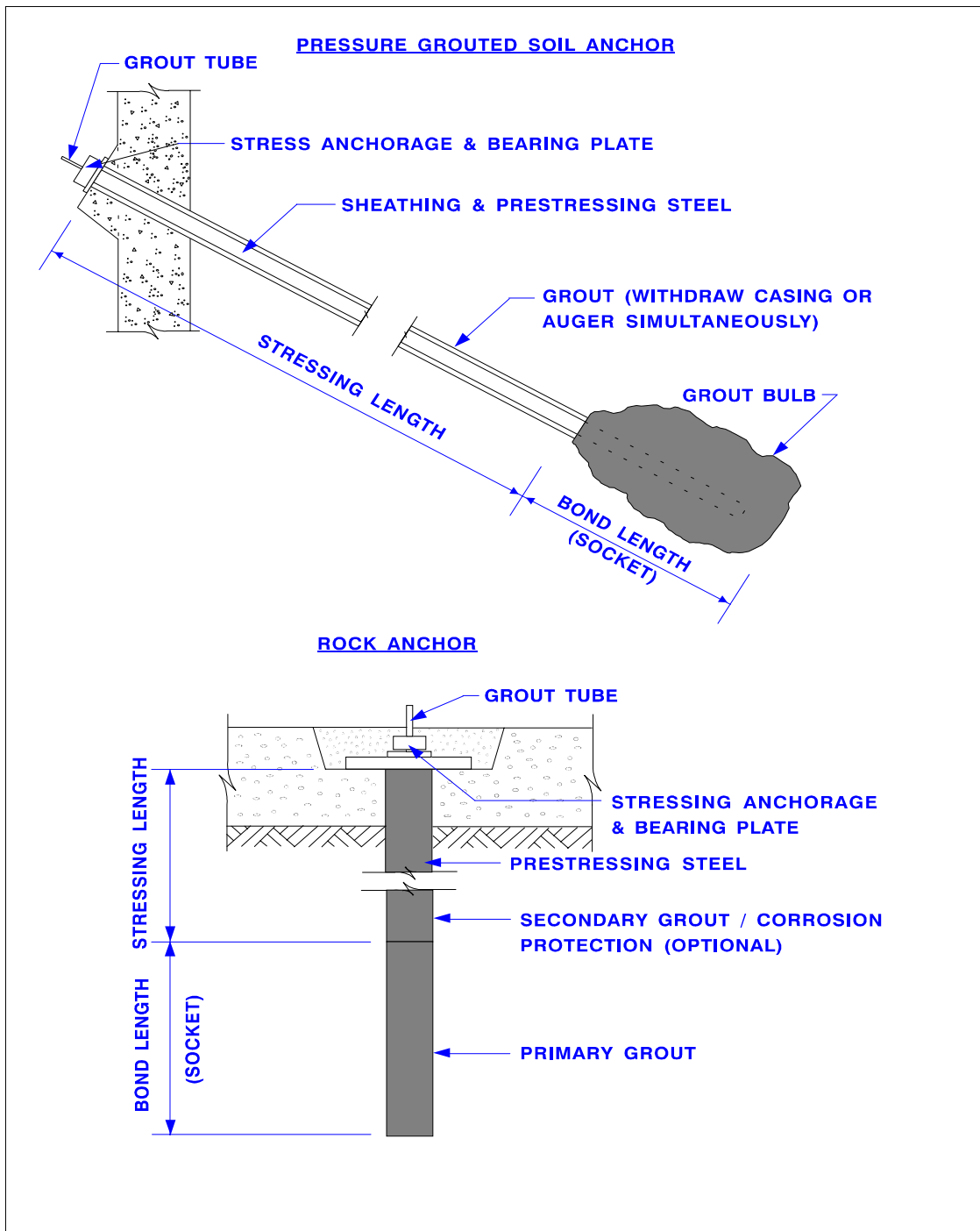

Figure 33
Basic Components of Ground Anchors

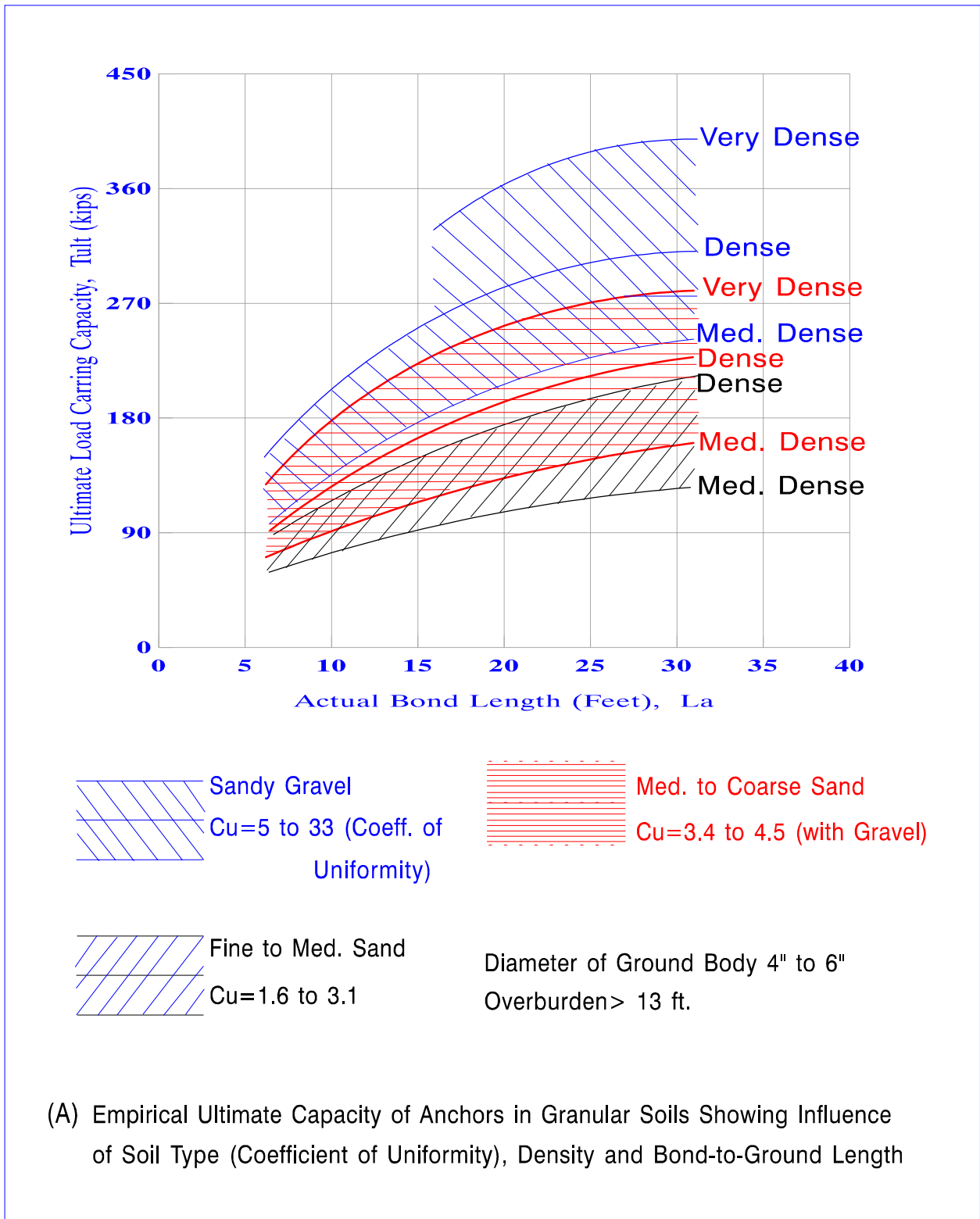

Figure 34
Estimate of Anchor Capacity

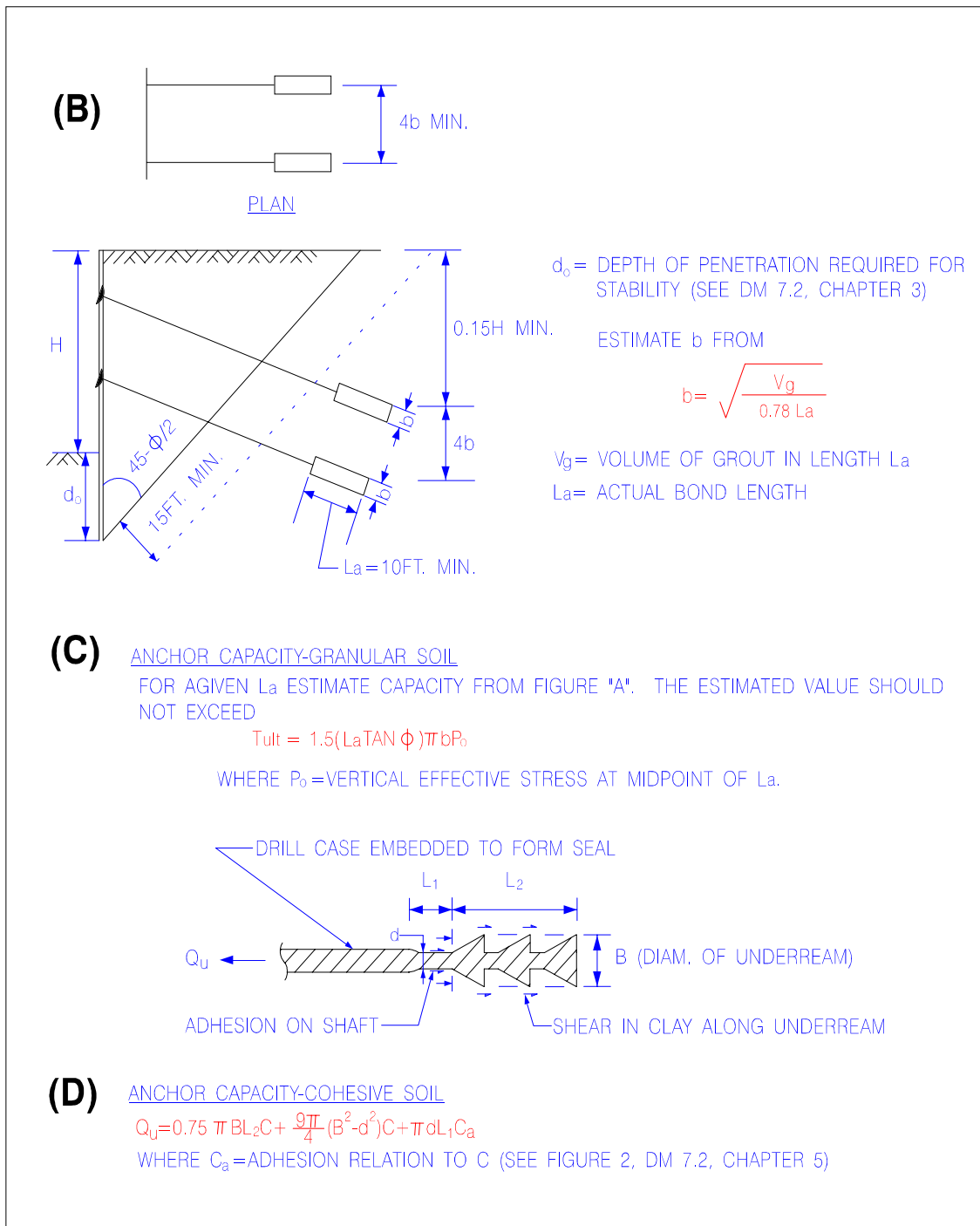

Figure 34 (Continued)
 Estimate of Anchor Capacity

Table 7
Types of Soil Anchors

Method	Shaft Type	Bell Type	Gravity Concrete	Grout Pressure (psi) ⁽¹⁾	Suitable Soils for Anchorage	Load Transfer Mechanism
1. LOW PRESSURE Straight Shaft Friction	12-24"	NA	A	NA	Very stiff to hard clays. Dense cohesive sands	Friction
Straight Shaft Friction (Hollow Stem auger)	6-18"	NA	NA	30-150	Very stiff to hard clay. Dense cohesive sands. Loose to dense sands	Friction
Underreamed Single Bell at Bottom	12-18"	30-42"	A	NA	Very stiff to hard cohesive soils. Dense cohesive sands. Soft rock.	Friction and bearing.
Underreamed Multi-bell	4 - 8"	8-24"	A	NA	Very stiff to hard cohesive soils. Dense cohesive sands. Soft rock	Friction and bearing
2. HIGH PRESSURE SMALL DIAMETER Non-	3 - 6"	NA	NA	150	Hard clays. Sands. Sand-gravel formations. Glacial till or hardpan	Friction or friction and bearing in permeable soils
Regrowable ⁽³⁾	3 - 8"	NA	NA	200-500	Same soils as for non-regrowable anchors plus: (a) Stiff to very stiff clay. (b) Varied and difficult	Friction and bearing

(1) Grout pressures are typical.

(2) Friction from compacted zone having locked in stress. Mass penetration of grout in highly pervious sand/gravel forms "bulb" anchor.

(3) Local penetration of grout will form bulbs which act in bearing or increase effective diameter.

A - Applicable

NA - Not Applicable

3.1.6 Displacement of Sheet Pile Walls. Damage to anchored sheet pile walls during earthquakes is known to be a function of the movement of the top of the sheet piles during the earthquake. Table 8 exhibits five categories of sheet pile damage levels reported in Ref. 3.2.6 (Kitajima and Uwabe, 1979). It shows that for sheet pile wall displacements of 4 inches (10 cm) or less, there was little or no damage to the waterfront structures as a result of the earthquake shaking. The level of damage to the waterfront structures increased in proportion to the magnitude of the displacements above 4 inches. Analysis of the information reported by the survey, the simplified theories, and the free earth support method of analysis, showed post-earthquake displacement at the top of the sheet pile wall is correlated to:

- a) The depth of sheet pile embedment below the dredge level,
- b) The distance between the anchor and the sheet pile.

Two anchored bulkheads were in place in the harbor of San Antonio, Chile, during the very high magnitude earthquake of 1985. A peak horizontal acceleration of about 0.6g was recorded within 3.2 miles (2 km) of the site. One anchored bulkhead experienced a permanent displacement of about 3 ft, and use of the bulkhead was severely restricted. There was evidence of liquefaction or at least poor compaction of the backfill, and tie rods may not have been preloaded. The second bulkhead developed a permanent displacement of only 6 inches, and the quay remained functional after the earthquake. This example gives evidence that anchored sheet pile walls can be designed to withstand large earthquakes.

Table 8
Description of the Reported Degree of Damage for Sheet Pile Wall

Degree of Damage	Description of Damage	Permanent Displacement at the Top of Sheet Pile	
		(Inches)	(Cm)
0	No damage	<1	<2
1	Negligible damage to the wall itself; noticeable damage to related structures (concrete apron)	4	10
2	Noticeable damage to walls	12	30
3	General shape of anchored sheet pile preserved, but significantly damaged	24	60
4	Complete destruction, no recognizable shapes of wall	48	120

3.2 STONE COLUMNS AND DISPLACEMENT PILES

3.2.1 Installation of Stone Columns. One of the most dramatic causes of damage to engineering structures from earthquakes has been the development of soil liquefaction beneath and around structures. The phenomenon is associated primarily, but not exclusively, with saturated cohesionless soils (Liquefaction of Soils During Earthquake, NRC, 1985).

The purpose of an effective soil improvement program is to mitigate the potential for liquefaction and minimize damaging settlement in the soil. Methods to achieve mitigation include: increase of material stiffness by intrusion of grout, chemicals, or stone columns and control or prevention of pore pressure development. Proper installation of stone columns by vibro-replacement mitigates the potential for liquefaction by increasing the density of the surrounding soil, increasing lateral stresses on the surrounding soil, providing drainage for the control of pore water pressures, and introducing a stiff element (stone column) which can potentially carry higher shear stress levels (Priebe, 1989). Since the first of these is very important, stone column should be placed by methods that increase the density of the surrounding soil.

The three most common methods of stone column installation are, top feed (gravel fed around surface annulus), bottom feed (gravel fed from tip of vibrator), and auger-casting with an internal gravel feeding system. The first two systems, commonly called vibro-replacement, involve the use of electrical vibrators employed to help advance the hole and densify the surrounding soil. The vibro-replacement process generally involves advancing the hole by means of water or air jets to a specified depth, feeding stone (gravel) into the hole, then beginning a series of lifting and lowering action of the vibrator (30 Hz) as the gravel is being added to densify the gravel and surrounding soil. Figure 35 (Quantitative Evaluation of Stone Column Techniques for Earthquake Liquefaction Mitigation, Baez and Martin, 1992) shows the top-fed method of installation. Figure 36 shows the typical range of soils densifiable by vibro-replacement and range of soils with potential for liquefaction.

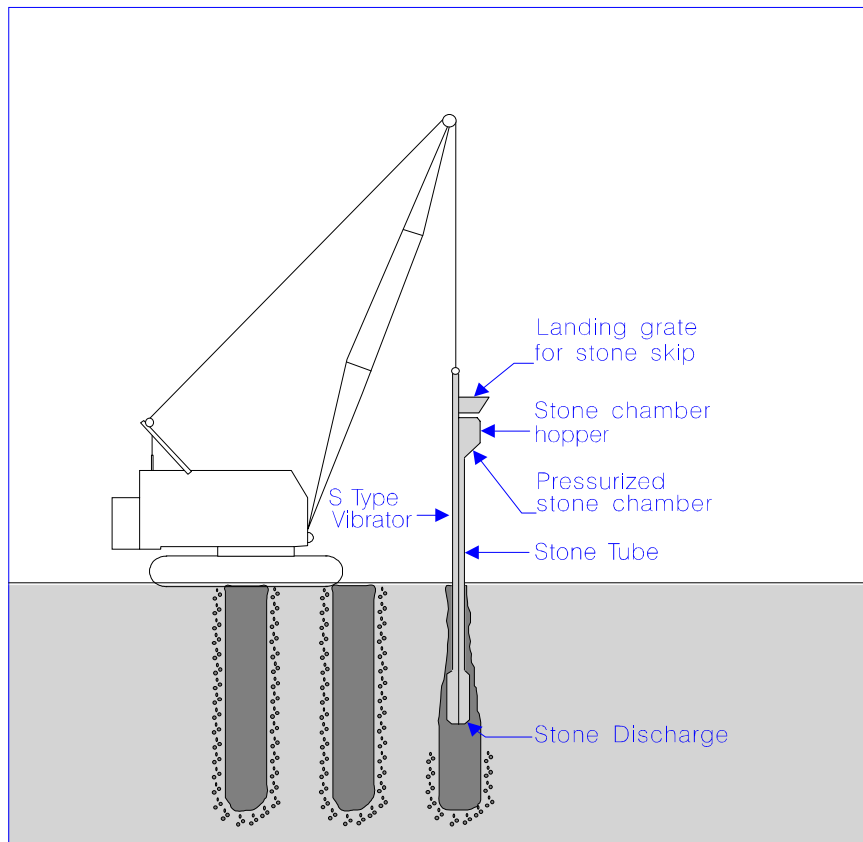
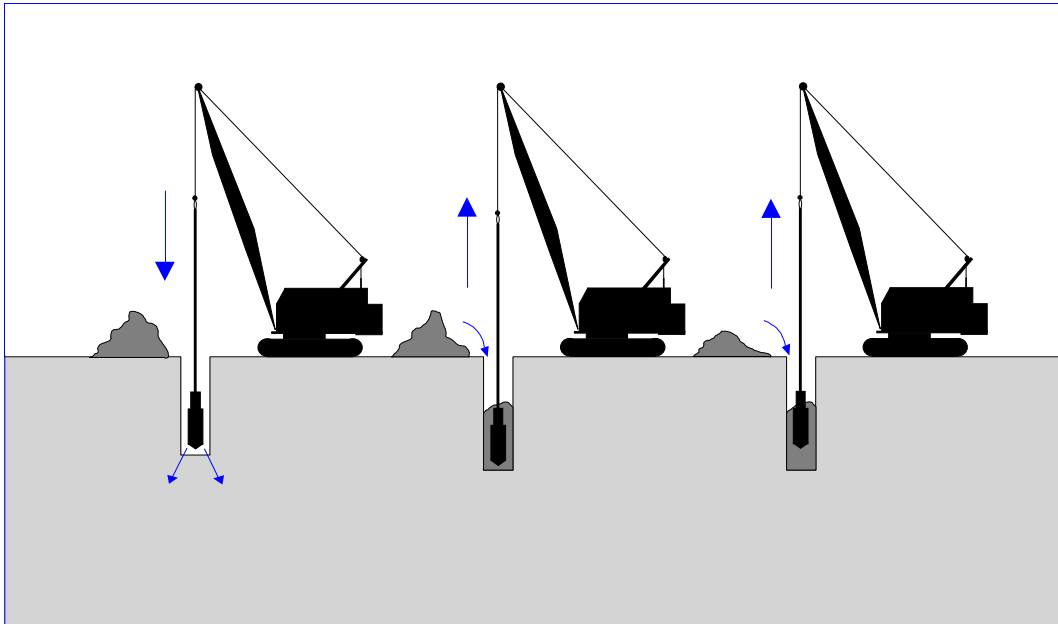

Figure 35
Installation of Stone Columns
120

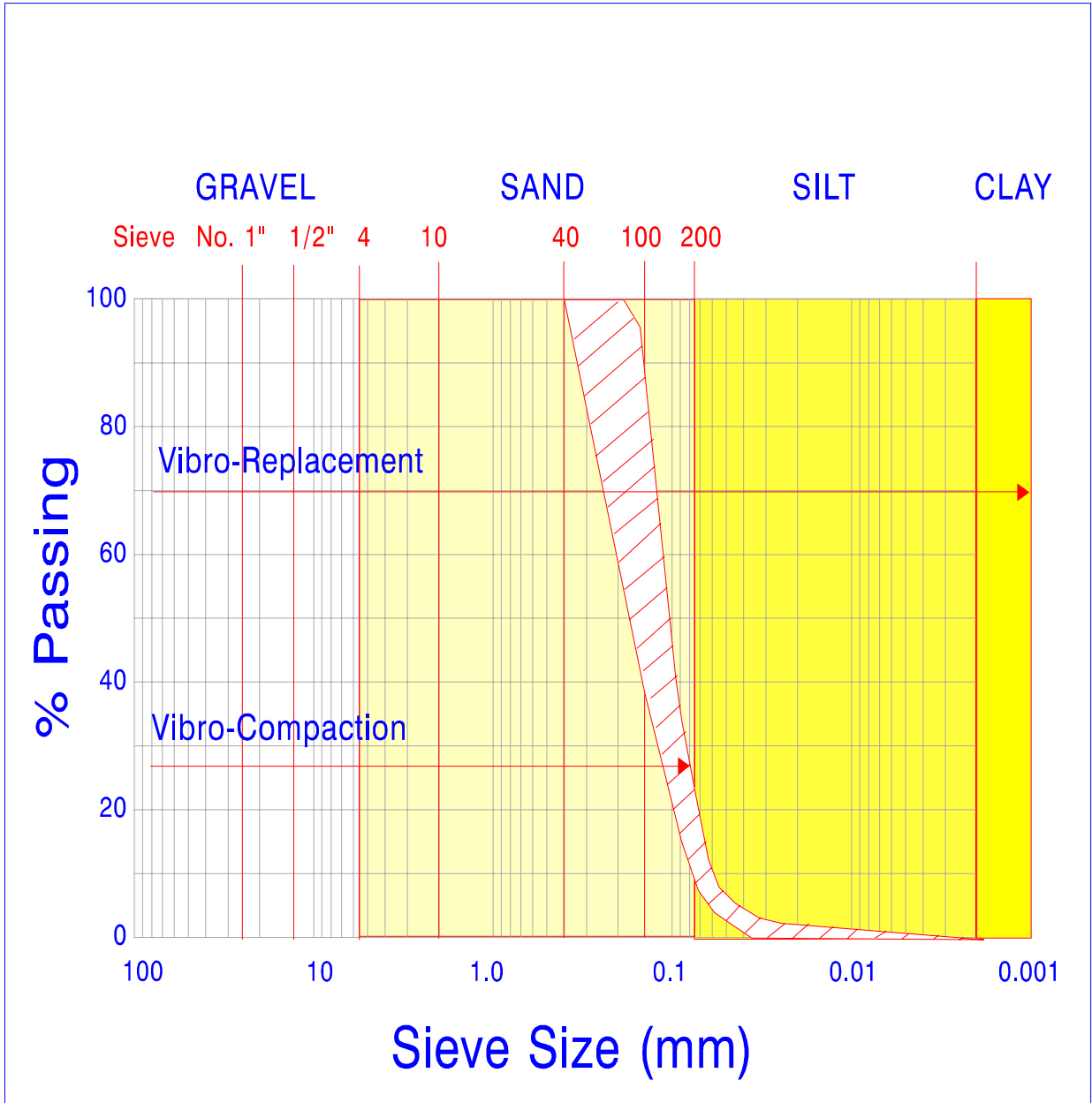

Figure 36
Typical Range of Soils Densifiable by Vibro-Replacement

3.2.2 Parameters Affecting Design Consideration. Parameters affecting the stone column performance include ground motion characteristics such as peak acceleration, frequency, and duration, and the properties of the soil stone column system. These involve degree of densification, shear moduli, compressibility, permeability, and the geometry of the system. The following parameters affect stone column response.

3.2.2.1 Soil Density. Pore pressure generation in a dense soil occurs more slowly than in a loose sand and hence liquefaction potential will be less. For loose sands once the state of initial liquefaction is reached, large ground deformations may occur. However, in dense sands, in the event that peak pore pressure value becomes equal to the initial confining pressure, the large shear strains cause significant dilation of the sand structure thereby maintaining significant residual stiffness and strength (NRC, 1985).

3.2.2.2 Coefficient of Permeability. To avoid significant generation of pore water pressure within the stone column, Seed and Booker (1976) specify that the permeability of the stone column should be at least two orders of magnitude larger than the surrounding soil.

3.2.2.3 Coefficient of Volume Compressibility. If the stone columns can be designed so that maximum pore pressure ratios (excess pore pressure to effective stress) are maintained below 0.5, the use of a constant coefficient of volume compressibility would be appropriate for dissipation analysis and the potential for settlement would be reduced.

3.2.2.4 Selection of Gravel Material. The U.S. Bureau of Reclamation (1974), has set standards for filters used in road and embankment construction. Gradation requirements based on particle size passing No. 15 and No. 50 sieves in a grain size analysis are combined to obtain a suitable filter that prevents pore pressure buildup and erosion.

Saito et al. (1987) report a similar principle but suggest a different equation for the selection of the stone column material. Based on experimental data they proposed a formula based on the grain size distribution of the stone column and the surrounding soil to ensure maximum permeability and prevent erosion on the soil:

$$20D_{s15} < D_{G15} < 9D_{s85}$$

where D_{s15} is diameter (mm) of soil particles which 15 percent is finer, D_{G15} is the diameter of gravel (stone) passing 15 percent, and D_{s85} is the diameter of soil passing 85 percent in a grain size analysis test.

3.2.3 Vibro-Replacement (Stone Columns). The vibro-replacement method is a modification of the vibroflotation method for use in soft cohesive soils.

Use a vibroflot, cylindrical, vertical hole to cut to the desired depth by jetting, and 0.5 to 1 cubic yard of coarse granular backfill (well graded between 1/2 and 3 inches) is dumped in. The vibroflot is allowed to compact the gravel vertically and radially into the surrounding soft soil. The process of backfilling and compaction by vibration continues until the densified stone column reaches the surface. The diameter of the resulting column will range from about 2 feet for stiffer clays (undrained shear strength greater than 0.5 tsf) to 3.5 feet for very soft clays (undrained shear strength less than 0.2 tsf). Stone columns are spaced at 3 to 9 feet, on centers, in square or triangular grid patterns under mat foundations. Cover the entire foundation area with a blanket of sand or gravel at least one foot thick to help distribute loads and to facilitate drainage. The allowable stress on a stone column q_a can be found from:

$$q_a = \frac{25s_u}{F_s}$$

where: s_u = undrained shear strength of surrounding soil

F_s = factor of safety

A factor of safety of 3.0 is recommended.

3.2.4 Vibroflotation and Vibro-Replacement. Where both cohesive and granular soils exist, vibro-compaction is combined with vibro-replacement using granular fill (1/2 to 2 inches). In addition to compaction of natural soil between probe positions, a stone column will also be formed at points of

penetration. This method is useful where layered sands and silts exist. Table 9 indicates the procedures and applications of the stone column methods.

Table 9
Vibro-Replacement for Stone Column

Method	Procedure Used	Application Limitation	Modification of Soil Properties
Vibro- Replace- ment Stone Column	Holes are jetted into the soil using water or air, and backfilled with densely compacted coarse gravel.	Used in soft fine grained soils (clays and silts). Faster than preloading.	Increased allowable bearing capacity and reduced settlement. Maximum depth of improvement about 65 ft. The properties of soil are relatively unchanged.

3.3 DYNAMIC SLOPE STABILITY AND DEFORMATIONS

3.3.1 Slope Stability Under Seismic Loading. Well compacted cohesionless embankments or reasonably flat slopes in insensitive clay that are safe under static conditions are unlikely to fail under moderate seismic shocks (up to 0.15 g or 0.20 g acceleration). Embankment slopes made up of insensitive cohesive soils founded on cohesive soil or rock can withstand higher seismic shocks. For earth embankments in seismic regions, provide internal drainage and select core material suited to resist cracking. In regions where embankments are made up of saturated cohesionless soil, the likelihood for liquefaction should be evaluated using detailed dynamic analysis (refer to Simplified Procedures for Estimating Dam and Embankment Earthquake Induced Deformations, Makdisi and Seed, 1978).

3.3.2 Seismically Induced Displacement. Computation of slope displacement induced by earthquakes requires dynamic analysis. A simplified computation procedure was pioneered by Newmark in 1965 using acceleration data.

3.3.3 Slopes Vulnerable to Earthquakes. Slope materials vulnerable to earthquake shocks are:

a) Very steep slopes of weak, fractured, and brittle rocks or unsaturated loess are vulnerable to transient shocks that are likely to induce the opening of tension cracks.

b) Loose, saturated sand may be liquefied by shocks that may resist sudden collapse of structure and flow slides.

c) Similar effects as subpar. b) are possible in sensitive cohesive soils with natural moisture exceeding the liquid limit.

d) Dry cohesionless material on a slope at the angle of repose will respond to seismic shock by shallow sloughing and slight flattening of the slope.

Seismically induced displacement of a slope in earth structures, such as dams or earth retaining structures can be computed using the Newmark method. The potential sliding blocks are identified using slope stability analysis.

3.3.4 Deformation Prediction From Acceleration Data. The earthquake induced displacement of a potential slope sliding block can be estimated from acceleration data using the Newmark method of prediction of embankment deformation induced by earthquake.

3.3.4.1 Computation Method. Deformation of slope caused by earthquake can be estimated from the following four steps. These steps are shown in Figure 37.

a) Identify a critical potential sliding block, using slope stability program to find the yielding coefficient of earthquake loading, K_y , required to cause failure.

b) Obtain an input earthquake motion appropriate for the specific sites.

c) Find the average acceleration, K_t , from the acceleration time history of the site using seismic response analysis, MSHAKE, or other equivalent linear analysis. The yield coefficient is calculated from the average acceleration time history.

d) Calculate the seismically induced displacement of the potential sliding block by double integrating the potential of K_t exceeding K_y .

3.3.4.2 Sliding Block Analogy. Figure 38 depicts the principal components of the sliding block analysis (Earthquake Resistance of Earth and Rock-Fill Dams Permanent Displacements of Earth Embankments by Newmark Sliding Block Analysis, Franklin and Chang, 1977). The potential sliding mass in Figure 38A is assumed to be in a condition of impending (limiting equilibrium) failure, so that the factor of safety equals unity. This condition is caused by acceleration of both the base and the mass toward the left of the sketch with an acceleration of N_g . Acceleration of the mass is limited to this value by the limit of shear stresses that can be exerted across the idealized sliding contact, so that if base acceleration were to increase, the mass would move downhill relative to the base. By D'Alembert's principle, the limiting acceleration is represented by an inertia force NW applied pseudostatically to the mass in a direction opposite to acceleration and at the same angle θ . Figure 38B

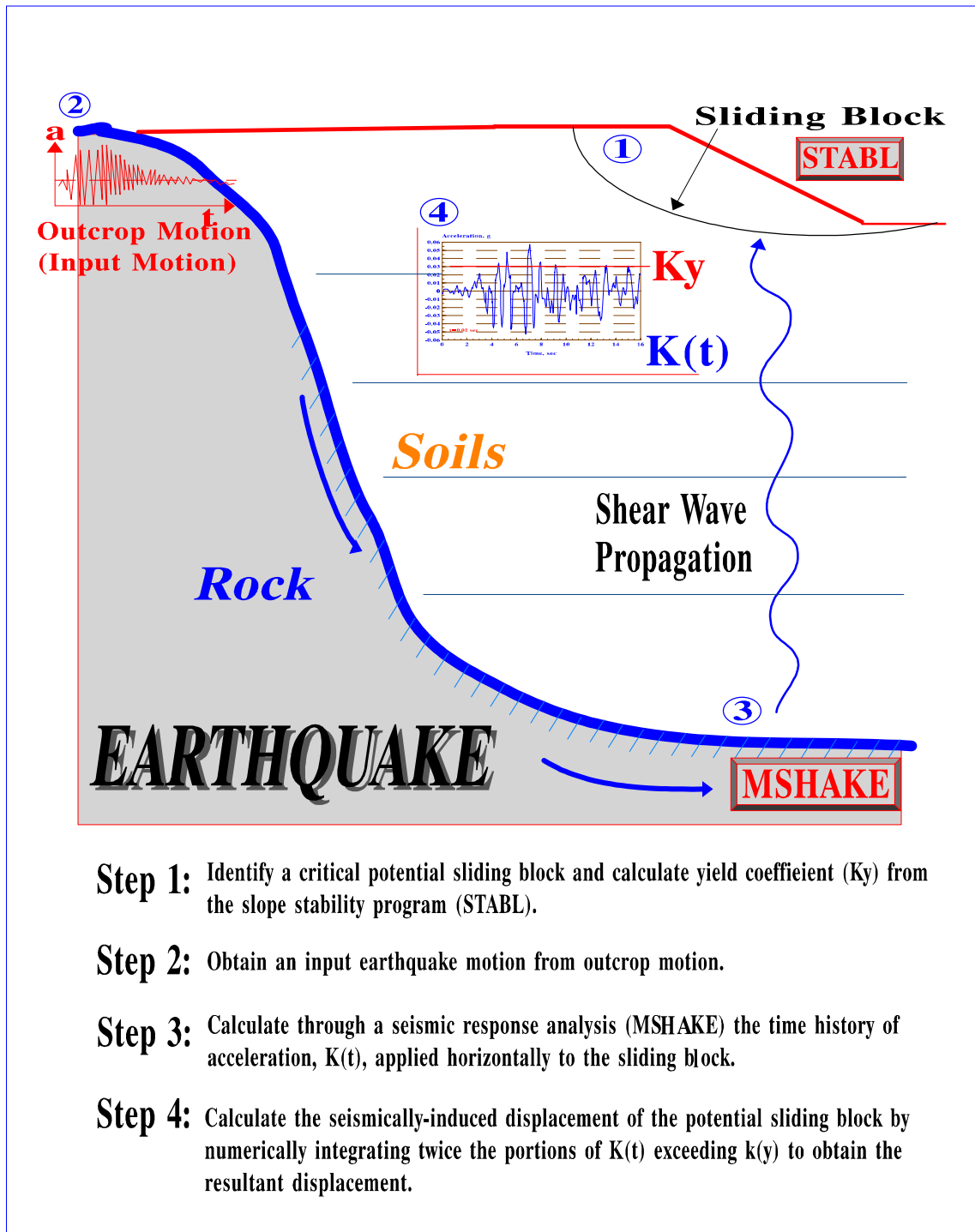

Figure 37
Prediction of Embankment Deformation Induced by Earthquake

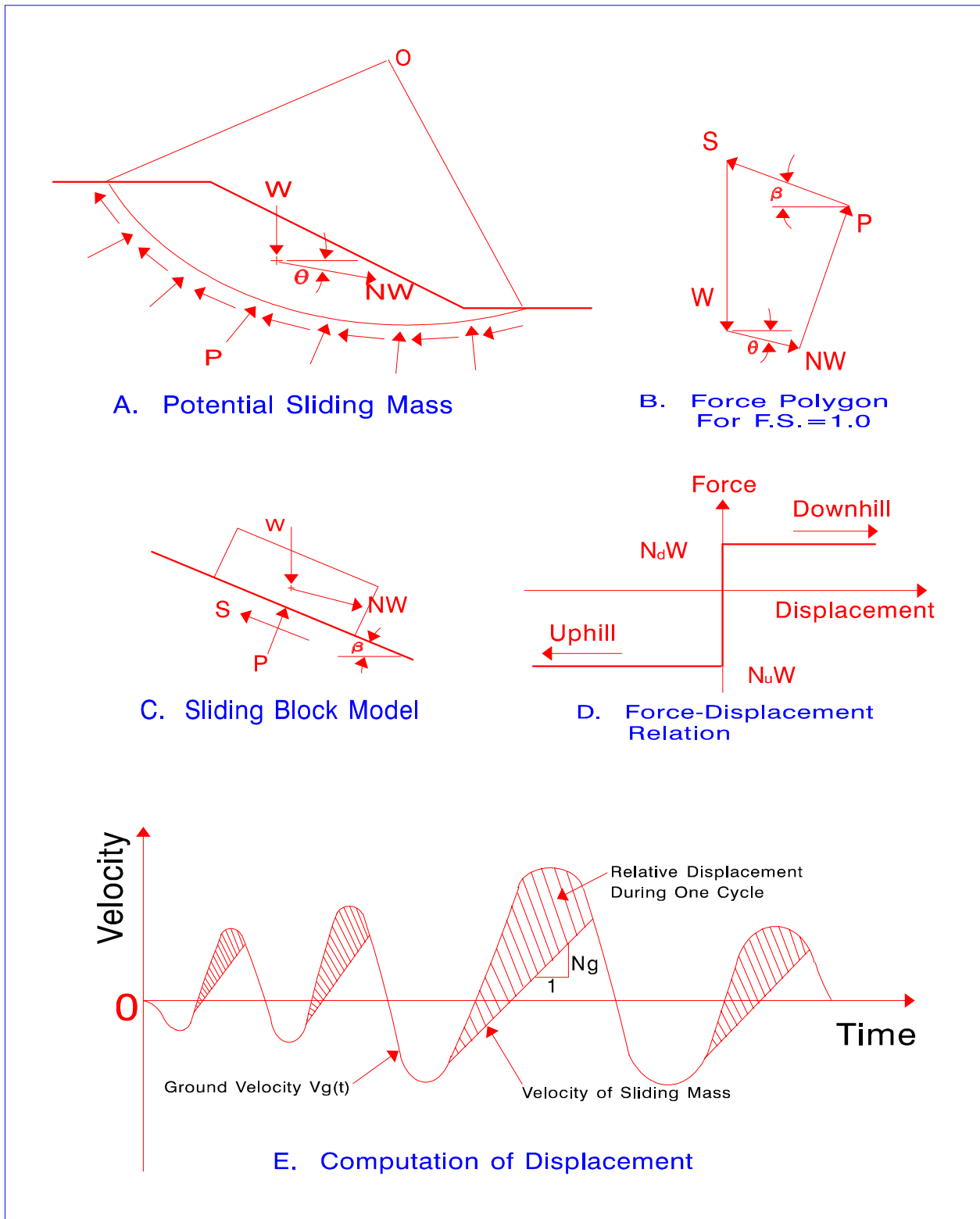

Figure 38
Principle Components of the Sliding Block Analysis

shows the balanced force polygon for the situation. The angle of inclination θ of the inertia force may be found as the angle that is most critical; i.e., the angle that minimizes N . Its value is usually within a few degrees of zero, and since the results of the analysis are not sensitive to it, the vertical component can generally be ignored or, equivalently, θ can be zero. The angle β is the direction of the resultant S of the shear stresses on the interface and is determined by the limit equilibrium stability analysis. The same force polygon applied to the model of a sliding block on a plane inclined at an angle β to the horizontal (Figure 38C). Hence, the sliding block model is used to represent the sliding mass in an embankment.

The force-displacement relation diagrammed in Figure 38D is assumed to apply to this sliding block system. The force in this diagram is the inertia force associated with the instantaneous acceleration of the block, and the displacement is the sliding displacement of the block relative to the base. It is usually assumed that resistance to uphill sliding is large enough that all displaced are downhill. If the base is subjected to a sequence of acceleration pulses (the earthquake) large enough to induce sliding of the block, the block will come to rest at some displaced position down the slope after the motion has ceased. The amount of permanent displacement, u , can be computed by using Newton's second law of motion, $F = ma$, to write the equation of motion for the sliding block relative to the base, and then numerically or graphically integrating (twice) to obtain the resultant displacement. During the time intervals when relative motion is occurring, the acceleration of the block relative to the base is given by:

$$\begin{aligned} u &= a_{rel} = (a_{base} - N) [\cos(\beta - \theta - \phi) / \cos\phi] \\ &= (a_{base} - N)\alpha \end{aligned}$$

where a_{rel} = relative acceleration between the block and the inclined plane

a_{base} = acceleration of the inclined plane, a function of time

N = critical acceleration level at which sliding begins

β = direction of the resultant shear force and displacement, and the inclination of the plane

θ = direction of the acceleration, measured from the horizontal

ϕ = friction angle between the block and the plane

The acceleration a_{base} is the earthquake acceleration acting at the level of the sliding mass in the embankment. It is assumed to be equal to the bedrock acceleration multiplied by an amplification factor that accounts for the quasi-elastic response of the embankment.

The amount of permanent displacement is determined by twice integrating the relative accelerations over the total duration of the earthquake record. It is assumed that ϕ , β , and θ do not change with time; thus, the coefficient α is constant and is not involved in the integration. In the final stage of analysis, the result of the integration are multiplied by the coefficient α , the determination of which requires knowledge of embankment properties and the results of the pseudostatic stability analysis. For most practical problems, the coefficient α may be assumed a value of unity, as it generally differs from unity by less than 15 percent.

The second step of acceleration integration is illustrated by the plot of base velocity versus time in Figure 38 E. Since the slope of the velocity curve is the acceleration, the limiting acceleration N_g of the block defines the velocity curve for the block by straight lines in those parts of the plot where the critical acceleration has been exceeded in the base. The area between the curves gives the relative displacement. Note that the block continues to move relative to the underlying slope even when a_{base} has fallen below N . The absolute velocity of the block continues to change linearly with time until the velocities of the block and the ground are the same. In effect, the friction between the block and the ground continues to act on the block until the ground catches up with it.

Computer programs are available to compute the cumulative displacement of the sliding block. The work of Franklin and Chang, 1977 and of others has demonstrated that the cumulative displacements calculated by the sliding block method increase as the ratio N/a_{base} decrease and tend to become significant when the ratio falls below 0.5.

APPENDIX A

COMPUTER PROGRAMS

A.1 Scope. This appendix lists computer programs which will be available on the NAVFAC Criteria Office Homepage and from the Construction Criteria Base (CCB), issued by the National Institute of Building Sciences, Washington, DC, and. The computer programs that will be available are:

A.1.1 LIQUFAC. A microcomputer program to evaluate soil liquefaction potential for sites located in a seismic zone area. For the liquefiable soil, the probable one dimensional compression settlement due to earthquake induced liquefaction is estimated. The results of analysis are summarized by a output and a graphic plot. Figure A-1 shows a result of computer output. Figure A-2 shows a graphic plot of the computer output results. The graphic plot also includes the settlement of the soil layers induced by the liquefaction. The plot also indicates the minimum standard penetration resistances required to avoid liquefaction of the site which was given design earthquake characteristics.

A.1.2 LATDEF2. A microcomputer program to evaluate liquefaction-induced lateral spread displacement. It uses two models in a seismic zone area. A free-face model for area near steep banks, and a ground-slope model for areas with gently sloping terrain. Figure A-3 exhibits the program data input screen. The program calculates lateral spread for each soil layer. After all soil layer data has been entered into the program, a total lateral displacement for all soil layers can be calculated.

APPENDIX A (Continued)

LIQUFAC
 -- Liquefaction Potential Analysis --
 by NAVFAC/IDI/PEI

Project Title: Homeport Construction
 Project Site: San Diego, CA
 Proposed Structure: Dike and Wharf
 Date: 5/20/1995
 Computed By: AHW

===== Factor of Safety =====									
No.	SPT		Soil	Elev.	%	Cyclic Stress Ratio		Fs	N Req'd
	N(60)	N1(60)		(ft)	Fines	Ri(Design)	Rf(Liquef)	Liquef	Against
					(CSR)	(CRR)			Fs = 1.0
1				100.0					
1	12	12.0		97.0					
1	11	11.0		92.0					
1			17.38	SM	15.0	0.303	N/A	N/A	10.90
2				90.0					
2	10	10.0		87.0					
2	9	9.0		82.0					
2	9	9.0		78.0					
2	8	8.0		72.0					
2			9.55	SM	20.0	0.391	0.187	0.480	19.66
3				70.0					
3	8	8.0		67.0					
3	7	7.0		62.0					
3	7	7.0		57.0					
3	6	6.0		52.0					
3			5.81	SM	25.0	0.434	0.146	0.335	25.36
				50.0					

Elev. of Ground Water Level = 90.0 ft.
 Not corrected by the energy delivered by sampler.

===== Dynamic Properties =====						
Layer	Unit	Vertical Stress		Shear Wave	Shear	
No.	Weight	Total	Effective	Velocity	Modulus	
	(pcf)	(psf)	(psf)	(fps)	(ksf)	
1	125.0	625.0	625.0	N/A	N/A	
2	120.0	2450.0	1826.0	486.5	882.16	
3	115.0	4800.0	2928.0	560.6	1122.29	

Max. Surf. Acc., a(max) = 0.47 g Earthquake Mag., M = 6.5

===== Settlement =====					
Layer	G/Gmax	PI	Cyclic	Volumetric	Settlement
No.			Shear Strain(%)	Strain(%)	(in.)
1	N/A		N/A	N/A	N/A
2	0.0880	15.0	1.4142	1.0750	2.5800
3	0.0100	20.0	17.4258	2.7057	6.4938

Figure A-1
 Example of Liquefaction Potential Analysis Output

LIQUFAC POTENTIAL ANALYSIS

Project Title: Homeport Construction
Project Site: San Diego, CA
Proposed Structure: Dike and Wharf
Date: 04/28/93
Computed By: AHW

Elev. ft

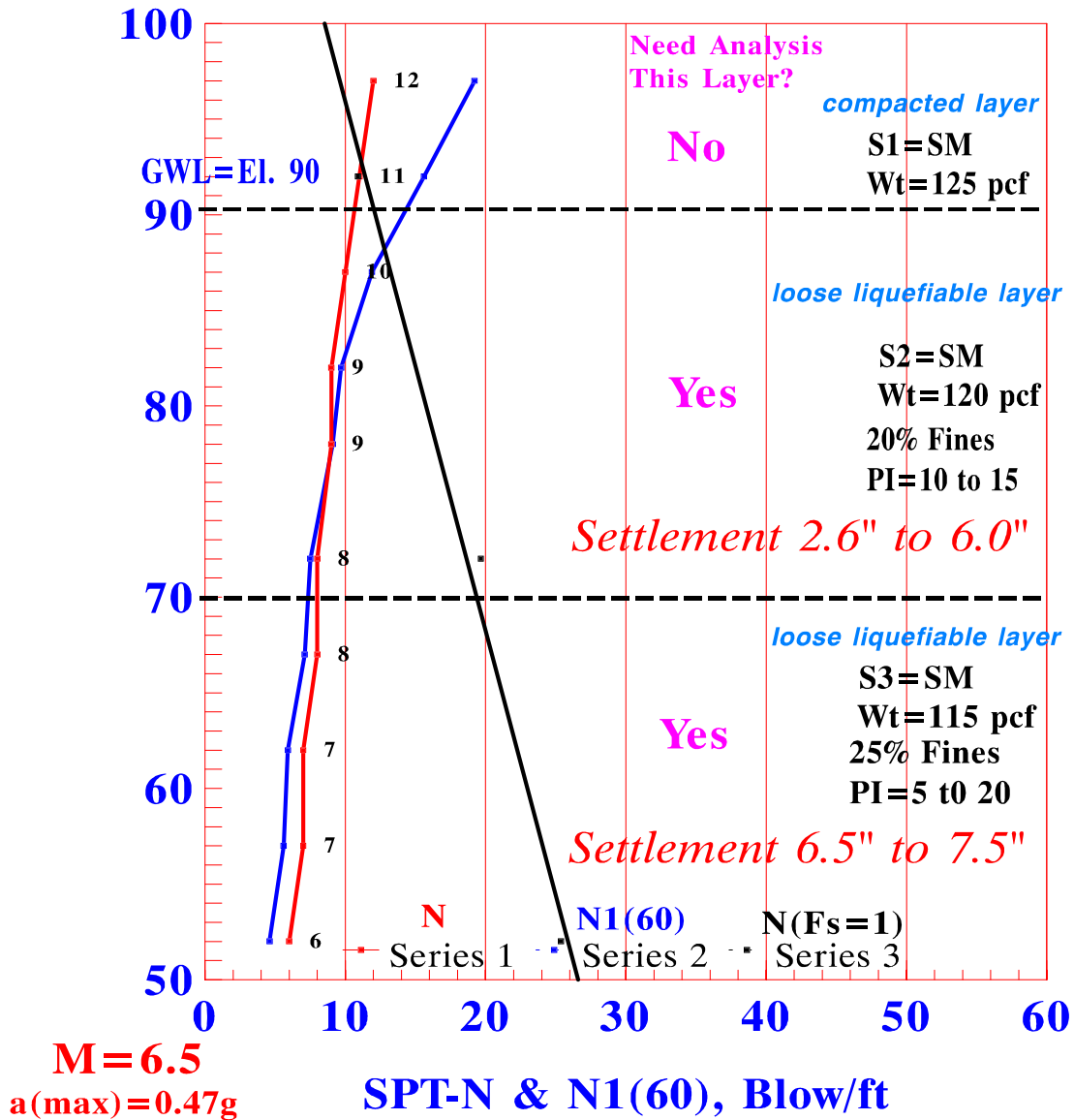

Figure A-2
Example of LIQUFAC Analysis Graphic Plot

APPENDIX A (Continued)

<i>Bartlett/Youd Lateral Spread</i>		<i>NCEL JMF 3-93</i>	
<i>Distance to energy source, km</i>	<input style="width: 50px;" type="text" value="10"/>	<i>Moment Magnitude</i> <small>6.0 < M < 8.0</small>	<input style="width: 50px;" type="text" value="7.5"/>
<i>This height saturated cohesionless layer, m</i> <small>0.3m < T < 12m</small>	<input style="width: 50px;" type="text" value="1.5"/>	<i>D50 15 Average D50 for T15</i> <small>0.1mm < D50 < 1mm</small>	<input style="width: 50px;" type="text" value="0.2"/>
<i>F15 Average fines content (<0.075mm) in T15, %</i> <small>0% < F < 50%</small>	<input style="width: 50px;" type="text" value="25"/>	<i>S slope %</i> <small>0.1% < S < 6%</small>	<input style="width: 50px;" type="text" value="2.5"/>
Equation () Free Face (∩) Slope	<i>Lateral spread, m for layer</i> <input style="width: 100px;" type="text" value="Previous layer"/>	<input style="width: 100px;" type="text" value="3.350357"/>	<input style="width: 100px;" type="button" value="Compute"/>
		<input style="width: 50px;" type="text" value="1"/>	<input style="width: 100px;" type="button" value="Next Layer"/>
	<i>Total spread, m for N layers</i>	<input style="width: 100px;" type="text" value="3.350357"/>	<input style="width: 100px;" type="button" value="Done"/>

Figure A-3
Example of LATDEF2 Data Input Screen

APPENDIX B

SYMBOLS

<u>Symbol</u>	<u>Designation</u>
A	Cross-sectional area; also amplitude.
B,b	Width in general, or narrow dimension of a foundation unit.
C _a	Unit adhesion between soil and pile surface or surface of some other foundation material.
C _u	Coefficient of uniformity of grain size curve.
C _a	Coefficient of secondary compression.
c	Cohesion intercept for Mohr's envelope of shear strength based on total stresses.
c'	Cohesion intercept for Mohr's envelope of shear strength based on effective stresses.
CSR	Cyclic stress ratio.
CRR	Cyclic resistance ratio.
D,d	Depth, diameter, or distance; also damping coefficient.
D _R	Relative density.
D ₅ , D ₆₀ , D ₈₅	Grain size division of a soil sample, percent of dry weight smaller than this grain size is indicated by subscript.
E	Modulus of elasticity of structural material.
E _s	Modulus of elasticity or "modulus of deformation" of soil.
e	Void ratio.
F _s	Safety factor in stability or shear strength analysis.
f	Frequency.
G	Shear modulus.
H,h	In general, height or thickness.
I	Moment of inertia.
k	Coefficient of permeability in general.
ksf	Kips per square foot pressure intensity.
ksi	Kips per square inch pressure intensity.
L,l	Length in general or longest dimension of foundation unit.
pcf	Density in pounds per cubic foot.
P _o	Existing effective overburden pressure acting at a specific height in the soil profile or on a soil sample.

APPENDIX B (Continued)

<u>Symbol</u>	<u>Designation</u>
p	Intensity of applied load.
q	Intensity of vertical load applied to foundation unit.
q _u	Unconfined compressive strength of soil sample.
R, r	Radius of pile, caisson, well, or other right circular cylinder.
S	Percent saturation of soil mass.
s	Shear strength of soil for a specific stress or condition in situ, used instead of strength parameters c and f.
T	Thickness of soil stratum, or relative stiffness factor of soil and pile in analysis of laterally loaded piles.
tsf	Tons per square foot pressure intensity.
W	Moisture content of soil.
γ _D	Dry unit weight of soil.
γ _{SUB} , γ _B	Submerged (buoyant) unit weight of soil mass.
γ _w	Unit weight of water, vary from 62.4 pcf for fresh water to 64 pcf for sea water.
ε	Unit strain in general.
δ, δ _v , δ _c	Magnitude of settlement for various conditions.
ρ	Foundation mass density.
σ ₁	Total major principal stress.
σ ₃	Total minor principal stress.
σ ₁ '	Effective major principal stress.
σ ₃ '	Effective minor principal stress.
σ _x , σ _y , σ _z	Normal stresses in coordinate directions.
v	Poisson's ratio.
τ	Intensity of shear stress.
τ _{max}	Intensity of maximum shear stress.
t, t ₁ , t ₂ , t _n	Time intervals from start of loading to the points 1, 2, or n.
φ	Angle of internal friction or "angle of shearing resistance," obtained from Mohr's failure envelope for shear strength.

REFERENCES

NOTE: THE FOLLOWING REFERENCED DOCUMENTS FORM A PART OF THIS HANDBOOK TO THE EXTENT SPECIFIED HEREIN. USERS OF THIS HANDBOOK SHOULD REFER TO THE LATEST REVISIONS OF CITED DOCUMENTS UNLESS OTHERWISE DIRECTED.

FEDERAL/MILITARY SPECIFICATIONS, STANDARDS, BULLETINS, HANDBOOKS, NAVFAC GUIDE SPECIFICATIONS, DESIGN MANUALS, AND P-PUBLICATIONS:

Unless otherwise indicated, copies are available from the Defense Printing Service Detachment Office (DPSDO), Standardization Document Order Desk, Building 4D, 700 Robbins Avenue, Philadelphia, PA 19111-5094.

DESIGN MANUALS

- | | |
|---------|-----------------------------------|
| DM-7.01 | Soil Mechanics. |
| DM-7.02 | Foundations and Earth Structures. |

P-PUBLICATIONS

- | | |
|-------|--|
| P-355 | Seismic Design for Buildings. |
| P-397 | Structures to Resist the Effects of Accidental Explosions. |

OTHER GOVERNMENT DOCUMENTS AND PUBLICATIONS:

ARMY PUBLICATIONS

- | | |
|--|--|
| TM 5-890-10-1 | Seismic Design Guidelines for Essential Buildings. |
| Miscellaneous Paper S-171-17, Report 5 | Earthquake Resistance of Earth and Rock-Fill Dams Permanent Displacements of Earth Embankments by Newmark Sliding Block Analysis, U.S. Army Engineer Waterway Experiment Station, EC, Vicksburg, MS, A. G. Franklin and F. K. Chang, 1977. |

(Unless otherwise indicated, copies are available from the Defense Printing Service Detachment Office (DPSDO), Standardization Document Order Desk, Building 4D, 700 Robbins Avenue, Philadelphia, PA 19111-5094.)

DEPARTMENT OF TRANSPORTATION

Wave Equation Analysis of Pile Driving, Vol. 1, G. G. Goble and F. Rausche, 1976.

(Unless otherwise indicated, copies are available from the Federal Highway Administration, Washington, DC.)

NAVAL FACILITIES ENGINEERING SERVICE CENTER

NCEL N-1827 An Analysis of Base Isolation Design Issues for Navy Essential Construction, J. Ferritto, 1991.

NCEL TR-939/
ITL-92-11 Seismic Design of Waterfront Retaining Structures.

TR-2016-SHR Procedures for Computing Site Seismicity.

(Unless otherwise indicated, copies are available from the Naval Facilities Engineering Service Center (NFESC), 1100 23rd Avenue, Port Hueneme, CA 93043-4370.)

NON-GOVERNMENT PUBLICATIONS:

Baez, J. I. and Martin, G. R., Quantitative Evaluation of Stone Column Techniques for Earthquake Liquefaction Mitigation, Earthquake Engineering, Tenth World Conference, 1992.

Barken, D. D., Dynamics of Bases of Foundation, McGraw Hill Book Company, Inc., 1962.

Beredugo, Y. O. and Novak, M., Coupled Horizontal and Rocking Vibrations of Embedded Footings, Canadian Geotechnical Journal, Vol. 9, No. 4, 1972.

Haupt, W. A., Isolation of Vibrations by Concrete Core Walls, Proceedings of the Ninth International Conference on Soil Mechanics and Foundation Engineering, Vol. 2, Tokyo, 1977.

Kausel, E. and Roesset, J. M., Dynamic Stiffness of Circular Foundations, Journal of the Engineering Mechanics Division, Vol. 101, No. EM6, 1975.

Richart, F. E., Soil Structural Interaction, Proceedings of the Ninth International Conference on Soil Mechanics and Foundation Engineering, Vol. 2, Tokyo, 1977.

Richart, F. E., Jr., Hall, S. R., and Woods, R. D., Vibrations of Soils and Foundations, Prentice-Hall, Inc., 1970.

Robertson, P. K. and Fear, C. E., Soil Liquefaction and Its Evaluation Based on SPT and CPT, Proceedings Workshop on Evaluation of Liquefaction Resistance of Soils, Salt Lake City, Utah, 1996.

Schnabel, P. B. and Seed, H. B., Acceleration in Rock for Earthquakes in the Western United States, Bulletin of the Seismological Society of America, Vol. 63, No. 2, 1973.

Seed, H. B., Murnaka, R., Lysmer, J., and Idris, I., Relationship Between Maximum Acceleration, Maximum Velocity, Distance From Source and Local Site Conditions for Moderately Strong Earthquake, EERC 75-17, University of California, Berkley, 1975.

AMERICAN SOCIETY FOR TESTING AND MATERIALS (ASTM)

ASTM D 3999	Determination of Modulus and Damping Properties of Soils Using the Cyclic Triaxial Apparatus
ASTM D 4015	Modulus and Damping of Soils by the Resonant-Column Method.
ASTM D 4428/ D 4428M	Cross-Hole Seismic Testing.
ASTM D 4945	High-Strain Dynamic Testing of Piles.

(Unless otherwise indicated, copies are available from American Society for Testing and Materials (ASTM), 100 Barr Harbor Drive, West Conshohocken, PA 19428-2959.)

AMERICAN SOCIETY OF CIVIL ENGINEERS (ASCE)

7-95 Minimum Design Loads for Buildings,
Section 4, Earthquake Loads.

Makdisi, F. I. and Seed, H. B., Simplified Procedures for Estimating Dam and Embankment Earthquake Induced Deformations, Journal of the Geotechnical Division, Vol. 104, No. GT7, 1978.

Novak, M. and Aboul-Ella, M., Impedance Function of Piles in Layered Media, Journal of the Engineering Mechanics Division, Vol. 104, 1978.

Owies, I. S., Response of Piles to Vibratory Loads, Journal of the Geotechnical Division, Vol. 103, 1977.

Richart, F. E., Jr., Foundation Vibrations, Journal of Soil Mechanics and Foundations Division, Vol. 86, No. SM4, 1960.

Roesset, J. R., Stiffness and Damping Coefficients of Foundations, Dynamic Response of Pile Foundations, Analytical Aspects, 1980.

(Unless otherwise indicated, copies are available from American Society of Civil Engineers (ASCE), 345 East 47th Street, New York, NY 10017.)

AMERICAN SOCIETY OF STATE HIGHWAY AND TRANSPORTATION OFFICIALS
(AASHTO)

AASHTO Standard Specification for Magnesium-Alloy Forgings.

(Unless otherwise indicated, copies are available from American Society of State Highway and Transportation Officials (AASHTO), 444 N. Capitol Street, N.W., Washington, DC 20001.)

NATIONAL RESEARCH COUNCIL (NRC)

Liquefaction of Soils During Earthquake.

(Unless otherwise indicated, copies are available from National Academy Press, Washington, DC.)

GLOSSARY

ACRONYMS

<u>AASHTO</u> .	American Association of State Highway and Transportation Official
<u>ASTM</u> .	American Association for Testing and Materials.
<u>CPT</u> .	Cone penetration test.
<u>CRR</u> .	Cyclic resistance ratio.
<u>CSR</u> .	Cyclic stress ratio.
<u>EBS</u> .	Earthquake Barrier System.
<u>FC</u> .	Fine content.
<u>FPS</u> .	Friction-Pendulum System.
<u>HDR</u> .	High-damping rubber bearing.
<u>LRB</u> .	Lead rubber bearing.
<u>MM</u> .	Modified Mercalli.
<u>NFESC</u> .	Naval Facilities Engineering Service Center.
<u>NRC</u> .	National Research Council.
<u>PDA</u> .	Pile driving analyzer.
<u>RFBI</u> .	Resilient frictional base isolation.
<u>SASW</u> .	Spectral analysis of surface waves.
<u>SDOF</u> .	Single-degree-of-freedom.
<u>SPT</u> .	Standard penetration test

DEFINITIONS

Dynamic Compaction. The use of high-energy impact to densify loose granular soils in situ.

Liquefaction. The sudden, large decrease of shear strength of a cohesionless soil caused by collapse of the soil structure, produced by shock or small shear strains, associated with sudden but temporary increase of pore water pressure.

Machine Foundation. A foundation that receive regular or irregular vibratory loads that are generated from rotating or impact machinery.

Pile Driving Analyzer (PDA). The PDA uses electronic measurements and the wave equation analysis method to immediately compute average pile force and velocity.

Response Spectrum. Useful information regarding frequency-dependent energy distribution of an earthquake derived from Fourier analysis.

State-of-the-Art. The scientific and technical level attained at a given time.

Tolerable Vibration. The level of vibration magnitude, ranging from "not noticeable to persons" to "danger to structures" that a structure is designed.

Vibroflot. A crane-suspended cylindrical penetrator with a water jet at the tip that is opened and acts in conjunction with vibrations to dig a hole.

Vibroflotation. A method to densify granular soils using a vibroflot to dig a hole and then backfilled with sand or gravel that is dumped in from the surface and densified.

Vibrodensification. The densification or compaction of cohesionless soils by imparting wave energy to the soil mass so as to rearrange soil particles resulting in less voids in the overall mass.

CUSTODIAN
NAVY - YD2

PREPARING ACTIVITY
NAVY - YD2

PROJECT NO.
FACR-1159

STANDARDIZATION DOCUMENT IMPROVEMENT PROPOSAL

INSTRUCTIONS

1. The preparing activity must complete blocks 1, 2, 3, and 8. In block 1, both the document number and revision letter should be given.
2. The submitter of this form must complete blocks 4, 5, 6, and 7.
3. The preparing activity must provide a reply within 30 days from receipt of the form.

NOTE: This form may not be used to request copies of documents, nor to request waivers, or clarification of requirements on current contracts. Comments submitted on this form do not constitute or imply authorization to waive any portion of the referenced document(s) or to amend contractual requirements.

I RECOMMEND A CHANGE:	1. DOCUMENT NUMBER MIL-HDBK-1007/3	2. DOCUMENT DATE (YYMMDD) 971115
3. DOCUMENT TITLE SOIL DYNAMICS AND SPECIAL DESIGN ASPECTS		
4. NATURE OF CHANGE (identify paragraph number and include proposed rewrite, if possible. Attach extra sheets as needed.)		
5. REASON FOR RECOMMENDATION		
6. SUBMITTER		
a. NAME (Last, First, Middle Initial)	b. ORGANIZATION	
c. ADDRESS (Include Zip Code)	d. TELEPHONE (Include Area Code) (1) Commercial (2) DSN (If applicable)	e. DATE SUBMITTED: (YYMMDD)
8. PREPARING ACTIVITY		
a. NAME COMMANDER NAVAL FACILITIES ENGINEERING COMMAND CRITERIA OFFICE	b. TELEPHONE (Include Area Code) (1) Commercial (2) DSN (757) 322-4203 262-4203	
c. ADDRESS (Include Zip Code) 1510 GILBERT STREET NORFOLK, VA 23511-2699	IF YOU DO NOT RECEIVE A REPLY WITHIN 45 DAYS, CONTACT: Defense Quality and Standardization Office 5203 Leesburg Pike, Suite 1403, Falls Church, VA 22041-3466 Telephone (703) 756-2340 DSN 289-2340	